

METRICA

MADE TO MEASURE

2026

SELECTION



PROMOTION

2026 SELECTION

DOUBLE LASER INCLIGRAD 2

- Portata 50 m (all'interno): 30 m (anteriore) + 20 m (posteriore)
- Possibilità di selezionare solo il raggio anteriore o posteriore
- Corpo in alluminio
- Inclinometro orizzontale/verticale e indicatore 0° e 90° Rotazione dello schermo
- Funzione Pittore di stanze
- Precisione ± 2 mm unidirezionale
- 5 funzioni Pitagora
- **Batteria ricaricabile integrata, USB-C**

EXPO DOUBLE INCLIGRAD 2:

6 x Ref. 61115 + EXPO EXPO DOUBLE INCLIGRAD 2
Espositore gratuito con il primo ordine per punto vendita

Ref.	
89339	



NEW

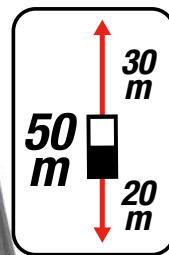

Ref.	Portata		
61115	50 m	120,00	105,85

FLASH MINI ALU30

- Portata 30m
- Corpo in alluminio per impieghi gravosi
- **Comodo formato tascabile (85 x 23 x 11,5 cm)**
- Precisione di misurazione: ± 5 mm
- Misurazione continua con visualizzazione dei valori Min/Max
- **Batteria ricaricabile agli ioni di litio (porta USB-C)**
- **Indicazione di carica**
- Possibilità di misurare dalla parte anteriore o posteriore del dispositivo e scelta delle unità di misura (pollici, piedi, ecc.)
- Fornito con cavo di ricarica USB

DISPLAY BOX
10 PCS

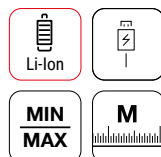

Ref.	Portata		
61660	30 m	58,00	47,50

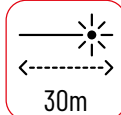

Ref.	
89341	

DISPLAY BOX: fornito con 10 x 61660

ALU 60

- Portata 60m
- Alloggiamento in alluminio di alta qualità
- **Numeri giganti HD**
- **Batteria ricaricabile agli Ioni di Litio (USB-C)**
- **Indicatore di carica**
- Funzione pittore / stanze
- Precisione +/- 2 mm
- Dimensioni 100 x 34 x 18 mm

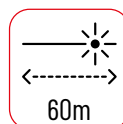
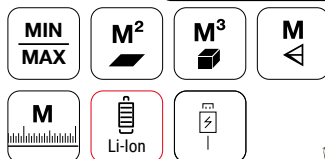

Ref.	Portata		
61661	60 m	119,00	89,00

DISPLAY BOX
6 PCS



Ref.	
89342	

DISPLAY BOX: fornito con 6 x 61661



I PREZZI SI INTENDONO IVA ESCLUSA

DOUBLE ALU 60 + 60 M

- Modello professionale con corpo in alluminio
- Dotato di un magnete sul retro per posizionare il dispositivo su strutture metalliche
- Portata: 60 + 60 m (interna)
- Precisione di misura: ± 2 mm (per ogni raggio)
- Funzione pittore / stanze
- Calcolo automatico di area, addizione, sottrazione e volume
- Misura continua con indicazione dei valori minimi e massimi
- Tenuta: IP 54
- Batteria ricaricabile agli ioni di litio (porta USB-C)
- Tecnologia HSA*
- Commutazione schermo Bianco e Nero

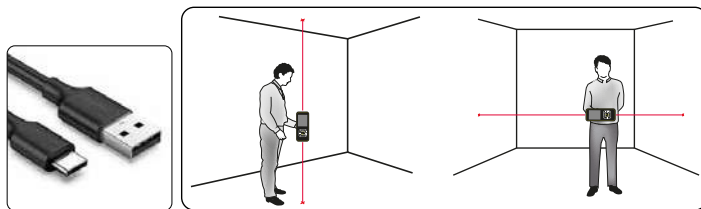
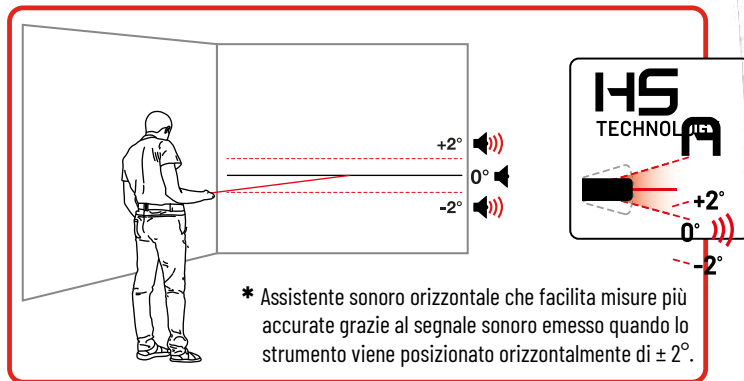
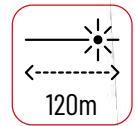

Ref.				
61662	120 m	1	159,00	129,00

ESPOSITORE IN METALLO
EXPO ALU 60+60: 4 x Ref. 61662 + EXPO ALU 60+60

Ref.			
89340	13 x 22 x 10 cm	1	

EXPO ALU 60+60
Ref. 89340



I PREZZI SI INTENDONO IVA ESCLUSA

2026 SELECTION

GO 40

Portata 40m

2 funzioni Pitagora
 Indicatore di carica
 Precisione +/- 2 mm
 Dimensioni 104 x 43 x 26 mm
 Fornito con batterie da 1,5 AAA

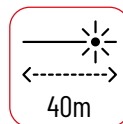

Ref.	Portata	63,00	53,00
61134	40 m		

MINI FLASH 30 M



- Display retroilluminato su 3 righe
- Funzione di misurazione continua con MAX e MIN
- Distanze, superfici, volumi
- 2 funzioni Pitagora
- 19 memorie Spegnimento automatico
- Con cinturino Batteria Li-Ion ricaricabile integrata
- In custodia
- Fornito con custodia



EXPO MINI FLASH 30:

6 x Ref. 61111 + EXPO MINI FLASH 30
 Espositore gratuito con il primo ordine per punto vendita

Ref.	Portata	71,50	59,00
89331			
61111	30 m		

ONE 30

- **Compatto, comodo e facile**
- Misura diretta e continua
- **Grande display retroilluminato con numeri giganti**
- Indicatore di carico
- Precisione: +/- 2 mm
- Dimensioni 105 x 46 x 26 mm
- Fornito con batterie da 1,5 AAA



FORNITO CON CINTURINO, CUSTODIA E BATTERIE

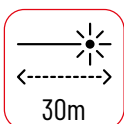

Ref.	Portata	58,50	47,80
61120	30 m		



I PREZZI SI INTENDONO IVA ESCLUSA

FLASH GREEN 60 & 100 M

- Nuovo raggio laser VERDE altamente visibile all'aperto o alla luce del sole
- **Inclinometro**
- Misura istantanea e continua
- **Batterie ricaricabili (USB) / batteria agli ioni di litio (inclusa)**
- Memoria: 30 misurazioni
- Precisione: +/- 2 mm
- Fornito con custodia e cavo di ricarica della batteria
- Dimensioni 118 x 52 x 27mm
- Funzione pittore / stanze

MONTAGGIO SU TREPPEDIE (NON INCLUSO)

INCLIGRAD

INCLUSO

SUPPORTO PER TREPPEDIE DA 1/4"

BATTERIE Li-Ion 3,7 V 850 mAh

M

M²

M³

M

α°

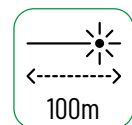
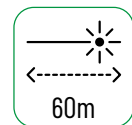

1/4"



Ref.	Portata	140,00	116,00
61060	60 m	140,00	116,00
61100	100 m	168,50	137,00

FLASH 30 & 60 M

- **4 funzioni Pitagora**
- Misure dirette e continue
- Misura diagonale
- **Minimo/massimo e funzione di memoria**
- Attacco per treppiede da 1/4"
- Precisione: +/- 2 mm
- Dimensioni 118 x 54 x 28 mm

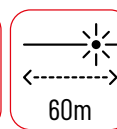
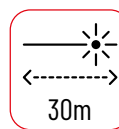

Ref. 61130

Ref. 61155

FORNITO CON CINTURINO, CUSTODIA E BATTERIE

4 articoli a scelta tra 61120, 61130, 61155, 61186, 61190 in OMAGGIO EXPO FLASH

+

M

MIN
MAX

M²

M³

M

Ref.	Portata	91,00	65,00
61130	30 m	91,00	65,00
61155	60 m	109,00	85,00



I PREZZI SI INTENDONO IVA ESCLUSA

FLASH C100

- Macchina fotografica con mirino, mostra il punto in cui viene misurata la distanza.
- Misure di superficie, volumi, 6 Pitagora
- Inclinometro e bolla elettronica
- Misura diretta e continua
- Misura diagonale
- Funzione min/max e memorie
- Micro USB e batterie ricaricabili
- Indicatore di carica
- Precisione +/- 2 mm
- Dimensioni 130 x 56 x 29mm

MIN
MAX

M

M³

M²

M

m



IP 54
WATER PROOF

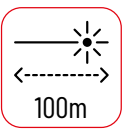

100m

HSA
TECHNOLOGY

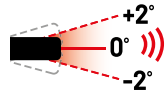

+2°
0°
-2°

FORNITO CON CAVO USB E BATTERIE RICARICABILI



Ref.	Portata	314,00	224,00
61186	100 m	314,00	224,00

FLASH 120 ZOOM

- Fotocamera con zoom 4X e mirino
- Foto del punto misurato con memoria di misura
- Registrazione video e vocale con memo
- Doppio inclinometro digitale (orizzontale e verticale)
- Funzione di misurazione continua, con valori massimi/minimi sempre visualizzati
- **7 funzioni Pitagora**
- Tracciamento guidato
- Distanze, aree, volumi
- Addizione e sottrazione di distanze, aree e volumi
- Supporto per le diagonali
- **16 GB di memoria interna**
- **Batterie ricaricabili**
- Cavo di collegamento PC/ricarica
- Precisione +/- 2 mm
- Dimensioni 145 x 60 x 29mm

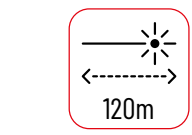
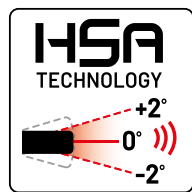

m

M²

M

M³

MIN
MAX

M



CAMERA ZOOM 4X

Ref.	Portata	362,00	278,00
61190	120 m	362,00	278,00

I PREZZI SI INTENDONO IVA ESCLUSA

FLASH 300 ZOOM

- Telecamera integrata per la ricerca dei punti di misura
- Zoom 2x e 4x
- Foto HD con misurazione + screen shot con misura memorizzata
- Impermeabilità IP65
- Ricarica senza fili (WIRELESS) e/o cavo USB-C
- Portata 300 m
- Precisione ± 2 mm
- Misura punto-punto (P2P)
- Sensore di inclinazione ad alta precisione
- Display a colori HD da 3"
- Luminosità del display: interno/esterno
- Commutazione schermo Bianco e Nero
- **Memoria 100 foto con misura**
- **Tecnologia HSA:** Assistente sonoro orizzontale per facilitare misurare grazie al segnale sonoro emesso quando lo strumento è posizionato a $\pm 2^\circ$ in orizzontale
- Fornito con 2 batterie Ni-Mh AAA, ricaricabili tramite porta USB-C

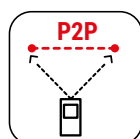
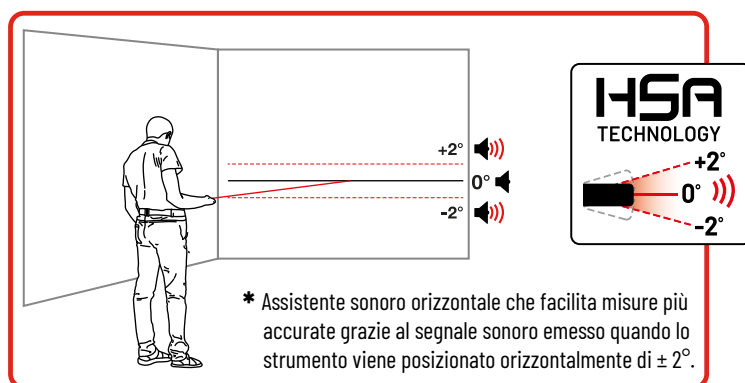

POINT TO POINT

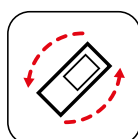

ROTATING SCREEN

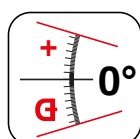

INCLINOMETRO

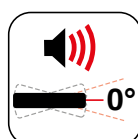

BEEP ALERT

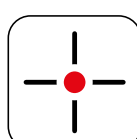

POINT FINDER CAMERA

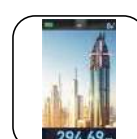

100 MEMORIE FOTOGRAFICHE



CARICA WIRELESS

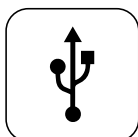

USB

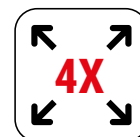

ZOOM 4X

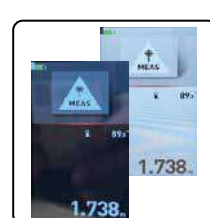

IP 65 WATER PROOF



ATTACCO POSTERIORE DA 1/4" PER TREPPIEDE

Ref.	Portata	460,00	355,00
61270	300 m		

I PREZZI SI INTENDONO IVA ESCLUSA



ESPOSITORE VETRINA LASER

- Vetrina espositiva per articoli laser
- Dimensioni vetrina 178 x 38 x 38 cm



Ref. **61111**
pag. 4



Ref. **61120**
pag. 4



Ref. **61134**
pag. 4



Ref. **61660**
pag. 2



Ref. **61661**
pag. 2



Ref. **61115**
pag. 2



Ref. **61662**
pag. 3



Ref. **61130 - 61155**
pag. 5



Ref. **61186**
pag. 6



Ref. **61190**
pag. 6



Ref. **61270**
pag. 7



Ref. **61060 - 61100**
pag. 5



Ref. **61385M**
pag. 16



Ref. **61386**
pag. 17



Ref. **61350**
pag. 18



Ref. **61395**
pag. 19



Ref. **61345**
pag. 20



Ref. **61392** pag. 21
Ref. **61792** pag. 22



Ref. **61432**
pag. 10



Ref. **61425**
pag. 9



Ref. **61435**
pag. 11



Ref. **61375M**
pag. 9



Ref. **60845**
pag. 12



Ref. **61438**
pag. 13



Ref. **61470**
pag. 15



Ref. **61415MPLUS**
pag. 14



Ref. **61410MPLUS**
pag. 14

Ref.



1

Con un ordine minimo di 1.500 € di articoli assortiti, vetrina in omaggio

I PREZZI SI INTENDONO IVA ESCLUSA

LASERBOX 360 + 1V + 2D GREEN

- Due magneti nella parte anteriore per fissare il laser al binario del pavimento
- Facile da posizionare contro il soffitto (a meno di 1 cm di distanza)
- Intensità del fascio laser regolabile (3 modalità)
- Sistema di blocco integrato per evitare le vibrazioni durante il trasporto, possibilità di proiettare i piani laser anche in posizione inclinata fissa
- Utilizzabile con un ricevitore (tipo 60749, non incluso) grazie alla sua funzione a impulsi
- Fornito con supporto magnetico a parete regolabile, bersaglio e custodia rigida
- **Batteria ricaricabile agli ioni di litio e cavo USB-C in dotazione**

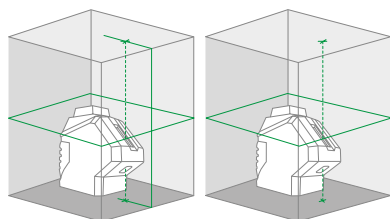

2 MAGNETI
PER FISSAGGIO
AL PROFILO TERRA



Ref.	Portata	Portata con ricevitore		
61375M	60 m	100 m	229,00	196,00

LASER GREEN CROSS

- Livella laser verde.
- Proietta un piano orizzontale e uno verticale formando 1 croce sulla parete.
- Uso interno/esterno (con ricevitore 60749 non incluso)
- 2 x 1,5 V AA batterie alcaline
- **Attacco vite treppiede 1/4"**

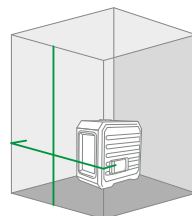
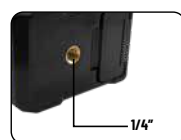

Ref.	Portata	Portata con ricevitore		
61422	15 m	40 m	53,00	49,00

GROUND 360°

- **Proietta 1 piano laser a 360° orizzontale + 1 piano verticale**
- Fornito con supporto a parete, mirino, cavo USB-C e custodia
- **Regolazione manuale dell'intensità del laser**
- **Batterie interne agli Ioni di Litio, ricaricabili tramite cavo USB-C in dotazione**
- Dimensioni 104x83x83mm
- Precisione di livellamento ± 3 m / 10 m
- Segnale di fuori livellamento

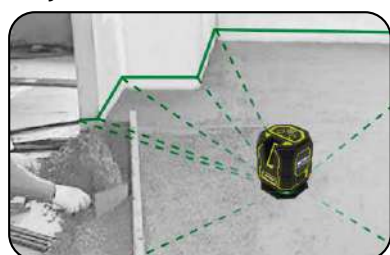

SPECIALE
PER MASSETTI

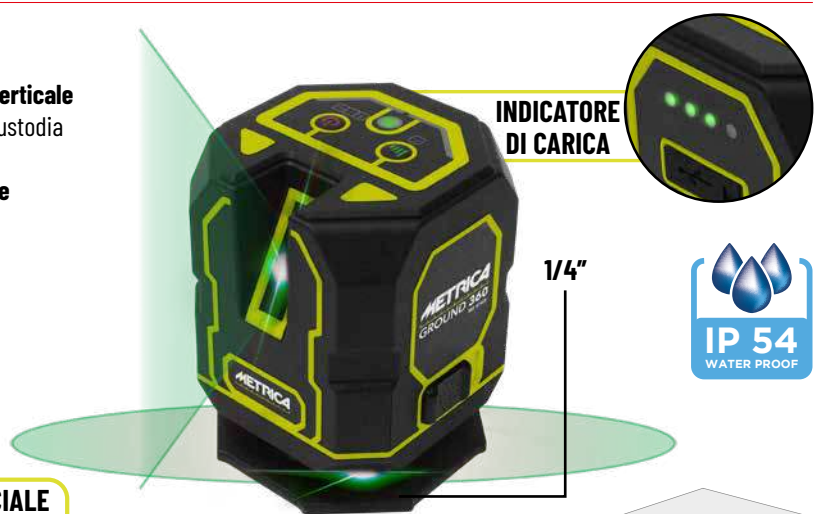

INDICATORE
DI CARICA



ACCESSORI
INCLUSI

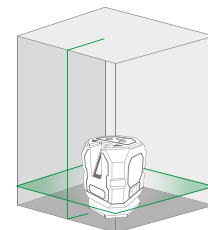

Ref.	Portata	Portata con ricevitore		
61425	30 m	50 m	190,00	160,00

I PREZZI SI INTENDONO IVA ESCLUSA

CROSS GREEN

- Livella laser verde.
- Proietta un piano orizzontale e uno verticale formando 1 croce sulla parete.
- Uso interno/esterno (con ricevitore non incluso, cod. 60749).
- Base magnetica e tappo in metallo per un facile impilaggio
- **Batteria interna agli Ioni di Litio ricaricabile tramite il cavo USB in dotazione**



Per ogni primo acquisto di 2 pz in omaggio EXPO 61432



ACCESSORI INCLUSI



INDICATORE DI CARICA



Ref.	Portata	Portata con ricevitore		
61432	30 m	40 m	139,00	99,50

KIT CROSS GREEN

- Kit fornito con Cross Green (Ref. 61432) + con **treppiede in acciaio** da 1,50 m con borsa (Ref. 60599)

NEW

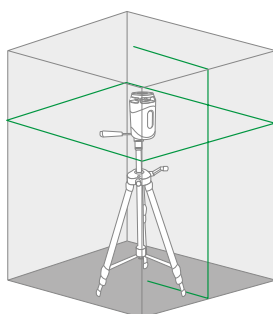

Ref.	Portata	Portata con ricevitore		
89327	30 m	40 m	164,50	112,50

I PREZZI SI INTENDONO IVA ESCLUSA

FLASH 360° "LA LATTINA"

- Livella laser verde. Proietta un piano laser orizzontale a 360° più un piano verticale a 90° che forma 1 croce sulla parete.
- Laser con intensità regolabile
- Utilizzo in interni/esterni (con ricevitore non incluso - cod. 60749)
- Base magnetica e coperchio in metallo per un facile impilaggio
- **Batterie agli Ioni di Litio ricaricabili tramite il cavo USB in dotazione**



LATTINA



ACCESSORI INCLUSI

Ref.	Portata	Portata con ricevitore		
61435	40 m / Ø 80 m*	60 m / Ø 120 m*	172,00	139,00

*solo per raggio orizzontale



Per ogni primo acquisto di 3 pz in omaggio EXPO 61435

INDICATORE DI CARICA



KIT FLASH 360° "LA LATTINA"

- Kit fornito con Flash 360° (Ref. 61435) + **treppiede in acciaio** da 1,50 m con borsa (Ref. 60599)

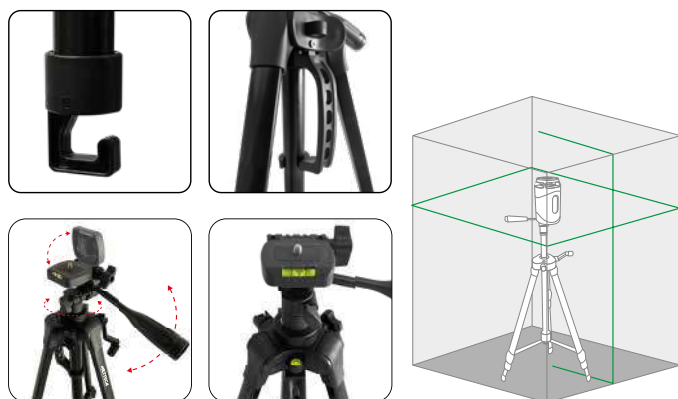

Ref.	Portata	Portata con ricevitore		
89328	40 m / Ø 80 m*	60 m / Ø 120 m*	197,50	153,00

I PREZZI SI INTENDONO IVA ESCLUSA



3D MINI GREEN

- Proietta 3 piani laser a 360°: un piano orizzontale e due piani verticali a 90° tra loro
- Fornito con supporto magnetico a parete, mirino, cavo USB, custodia e telecomando
- Batteria Li-ion integrata, 4/6h di autonomia, ricaricabile tramite il cavo USB in dotazione
- Dimensioni 95 x 75 x 75 mm



INDICATORE DI CARICA



Ref.	Portata	Portata con ricevitore (non incluso)		
60845	30 m / Ø 60 m	50 m / Ø 100 m	279,00	235,00

KIT 3D MINI GREEN

- Kit fornito con Flsah 360° (Ref. 61435) + treppiede in acciaio da 1,50 m con borsa (Ref. 60599)

NEW

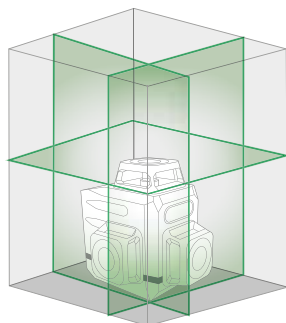

Ref.	Portata	Portata con ricevitore (non incluso)		
89329	30 m / Ø 60 m	50 m / Ø 100 m	304,50	249,00

I PREZZI SI INTENDONO IVA ESCLUSA

3D ACTION GREEN

- Superficie gommata
- Proietta 3 piani laser a 360°: un piano orizzontale e due piani verticali a 90° tra loro.
- Fornito con supporto magnetico a parete, bersaglio, cavo USB-C, custodia e telecomando
- Batterie interne Li-ion, 10h di autonomia (ciascuna), ricaricabili tramite cavo USB-C in dotazione
- Dimensioni 120x115x80mm
- Regolazione intensità laser



BATTERIE LI-ION



INDICATORE DI CARICA



1/4"
5/8"

ACCESSORI INCLUSI



TELECOMANDO

Ref.	Portata	Portata con ricevitore (non incluso)		
61438	30 m / Ø 60m	50 m / Ø 100 m	340,00	268,00

KIT 3D ACTION GREEN

- Kit fornito con Flsah 360° (Ref. 61435) + **treppiede in acciaio** da 1,50 m con borsa (Ref. 60599)

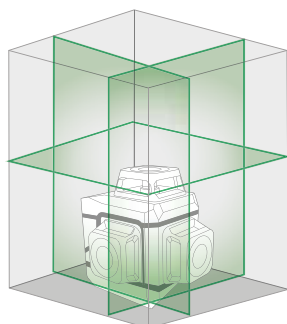

NEW



Ref.	Portata	Portata con ricevitore (non incluso)		
89330	30 m / Ø 60m	50 m / Ø 100 m	365,50	282,00

I PREZZI SI INTENDONO IVA ESCLUSA

LIVELLO LASER METRICA 3D

- Proietta 3 piani laser a 360° e 4 quadrati sulle pareti
- Altissima visibilità (modello PROFESSIONAL)
- Possibilità di piani laser fissi e inclinati
- Finestre ottiche
- Filo a piombo sempre visibile
- **2 batterie agli Ioni di Litio con un'autonomia fino a 30 ore**
- Occhiali in dotazione
- Custodia molto robusta
- Dimensioni 140 x 160 x 85 mm
- Opzionali: ricevitori, treppiedi, base scorrevole



INDICATORE
DI CARICA



USB-C
CHARGE



IP 54
WATER PROOF



SUPPORTO
MAGNETICO
PER PARETI
INCLUSO

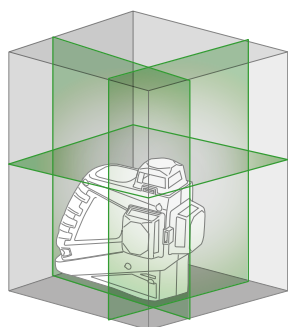

PORTA USB-C
INTEGRATA



TELECOMANDO



30
ORE

SET DI 2
BATTERIE
AGLI IONI
DI LITIO



ACCESSORI
INCLUSI



Ref. 60560
NON INCLUSO



Ref.		Portata	Portata con ricevitore (non incluso)		
61410MPLUS	●	30 m / Ø 60 m	50 m / Ø 100 m	495,00	410,00
61415MPLUS	●	20 m / Ø 40 m	40 m / Ø 80 m	363,00	287,00

I PREZZI SI INTENDONO IVA ESCLUSA

NEW

NIVEAU LASER METRICA 4 D

- Autolivello laser verde. **Proietta 4 piani laser a 360°**: due piani orizzontali e due piani verticali a 90° tra loro.
- 2 croci a soffitto e a pavimento esterni alla base della struttura
- Filo a piombo sempre visibile con 4 squadre a parete
- Vetrini ottici
- Alta visibilità
- Facile posizionamento a filo **soffitto** e a **pavimento** (< 2 cm)
- Uso interno ed esterno (con ricevitore non incluso)
- **Sistema di bloccaggio integrato** per evitare vibrazioni durante il trasporto, possibilità di proiettare i piani laser anche in posizione fissa ed inclinata
- Forma compatta, rivestimento in gomma antiscivolo e antiurto
- **2 batterie ricaricabili agli ioni di litio**
- **Porta USB-C integrata** sullo strumento
- **Indicatore di carica della batteria a LED**
- Il telecomando consente di attivare i diversi fasci a piacere, di regolarne l'intensità (3 possibili livelli di potenza) e di attivare la modalità a impulsi per l'utilizzo con il ricevitore
- Viene fornito con supporto magnetico a parete, in scatola rigida



1/4"

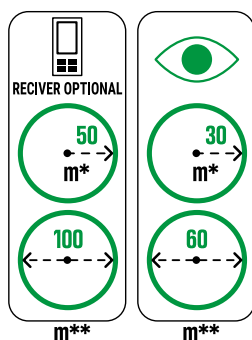
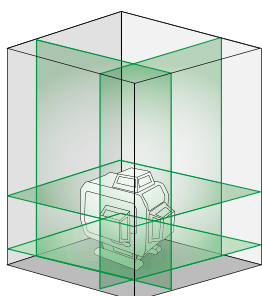

TELECOMANDO

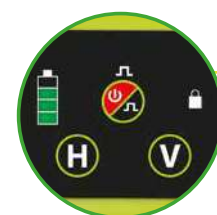

INDICATORE DI CARICA



PORTA USB-C INTEGRATA

Ref.	Portata	Portata con ricevitore (non incluso)		
61470	30 m / 60 m	50 m / 100 m	549,00	459,00

I PREZZI SI INTENDONO IVA ESCLUSA

BRAVO LASER ROTATIVO H4

- Laser rosso autolivellante con funzione manuale di doppia pendenza
- Filo a piombo laser per pavimenti e soffitti
- Portata di 500 m (Ø)
- 4 maniglie in gomma per una movimentazione facile ed efficace
- Ricezione del telecomando su tutti e 4 i lati dell'unità
- Calotta in lega metallica
- Indicatore di carica a LED
- Fornito con batteria ricaricabile Li-Ion
- Dimensioni 220 x 220 x 210 mm

500 m 1mm/10m USB-C CHARGE

TILT 60 - 120 300 - 600 rpm Li-Ion

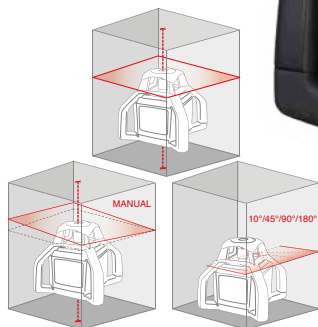

NEW

IP 66 WATER PROOF

Ref.	Portata		
61385M	Ø 500 m	670,00	465,00

Fornito con ricevitore standard Ref. 60724M

NEW

Ref.			
89333		805,50	699,00

Fornito con ricevitore millimetrico Ref. 61326 in sostituzione del 60724M

ACCESSORI INCLUSI



OMAGGIO



KIT BRAVO LASER ROTATIVO H4

Composto da: Ref. 61385M - Ref. 60581 - Ref. 60621

24 ORE
SPEDIZIONE
RAPIDA



Ref. 61385M

Ref.			
89332		909,00	620,00

Fornito con ricevitore Ref. 60724M

Ref. 60581
ALTEZZA 95 ÷ 195 CM



Ref. 60621

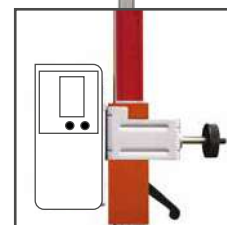

ALTEZZA 2 M 40

OMAGGIO



ACCESSORI INCLUSI



NEW

Ref.			
89337		1044,50	834,00

Fornito con ricevitore millimetrico Ref. 61326 in sostituzione del 60724M

T I PREZZI SI INTENDONO IVA ESCLUSA

BRAVO LASER ROTATIVO H4 GREEN

- Laser verde autolivellante con funzione manuale di doppia pendenza
- Filo a piombo per pavimenti e soffitti
- Portata di 500 m (Ø)
- 4 maniglie in gomma per una movimentazione facile ed efficace
- Ricezione del telecomando su tutti e 4 i lati dell'unità
- Calotta in lega metallica
- Indicatore di carica a LED
- Fornito con batteria Li-Ion di lunga durata
- Dimensioni 220 x 220 x 210 mm



500 m
 1mm/10m

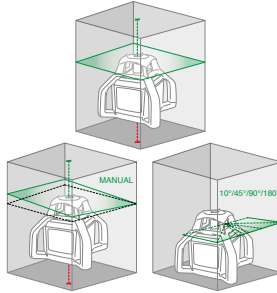

OMAGGIO

INDICATORE DI CARICA



Ref.	Portata		
61386	Ø 500 m	750,00	558,00

Fornito con ricevitore Ref. 61387

NEW

Ref.			
89320		912,00	739,00

Fornito con ricevitore millimetrico Ref. 61393 in sostituzione del 61387

ACCESSORI INCLUSI



TELECOMANDO GOMMATO

KIT BRAVO LASER ROTATIVO H4 GREEN

Composto da: Ref. 61386 - Ref. 60581 - Ref. 60621



Ref. 61386

Ref. 60621

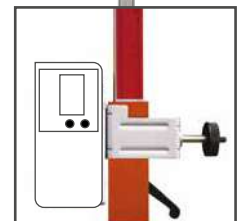

ALTEZZA 2 M 40

Ref. 60581

ALTEZZA 95 ÷ 195 CM

OMAGGIO

Ref.			
89325		989,00	712,00

Fornito con ricevitore Ref. 61387

NEW

Ref.			
89336		1151,00	910,00

Fornito con ricevitore millimetrico Ref. 61393 in sostituzione del 61387

ACCESSORI INCLUSI



I PREZZI SI INTENDONO IVA ESCLUSA

BRAVO LASER ROTATIVO HV4

- Laser rosso orizzontale e verticale autolivellante
- Filo a piombo laser per pavimenti e soffitti
- Portata 500 m Ø
- Doppia pendenza manuale (inclinazioni)
- Rotazione orizzontale o verticale
- Scansione con 4 angolazioni e funzione TILT
- Calotta in lega metallica
- Fornito con bersaglio, occhiali, batteria ricaricabile NI-MH
- Precisione ± 3mm / 30m
- Dimensioni 220 x 220 x 210 mm
- Pacco batteria aggiuntivo (Ref. 60739)

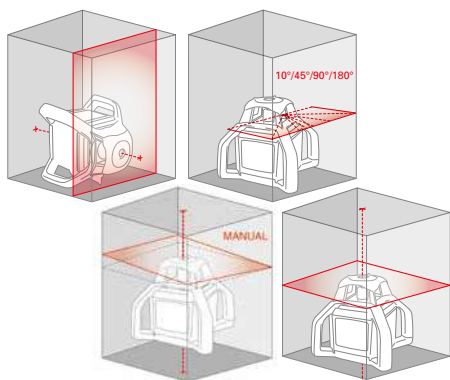

Ref.	Portata	1190,00	720,00
61350	Ø 500 m		

KIT BRAVO LASER ROTATIVO HV4

Composto da: Ref. 61350 - Ref. 60581 - Ref. 60621

Ref. 61350

Ref. 60581
ALTEZZA 95 + 195 CM

Ref. 60621
ALTEZZA 2 M 40

24 ORE SPEDIZIONE RAPIDA

OMAGGIO

Ref.	1339,00	895,00
89293		

I PREZZI SI INTENDONO IVA ESCLUSA

BRAVO LASER ROTATIVO HV4 GREEN

- Laser verde orizzontale e verticale autolivellante
- Filo a piombo laser per pavimenti e soffitti ad alta visibilità
- Portata 500 m Ø
- Doppia pendenza manuale (inclinazione)
- Rotazione orizzontale o verticale
- Tilt e scansione su 4 angoli
- Calotta in lega metallica
- Ricevitore a 4 settori e telecomando inclusi
- Fornito con batteria ricaricabile agli ioni di litio a lunga durata
- Precisione ± 3mm / 30m
- Dimensioni 220 x 220 x 210 mm



ACCESSORI INCLUSI

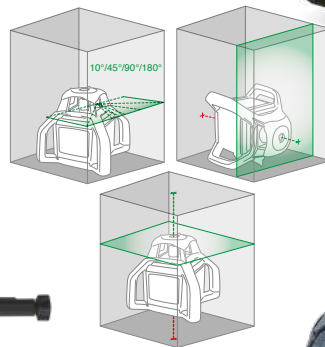

5/8"

5/8"



INDICATORE DI CARICA

TELECOMANDO GOMMATO INCLUSO



Ref. Portata

61395 Ø 500 m 1250,00 810,00

OMAGGIO



KIT BRAVO LASER ROTATIVO HV4 GREEN

Composto da: Ref. 61395 - Ref. 60581 - Ref. 60621

Ref. 61395



5/8"



Ref. 60581

ALTEZZA 95 ÷ 195 CM



Ref. 60621

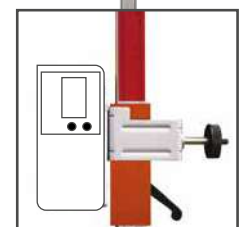

ALTEZZA 2 M 40



OMAGGIO

ACCESSORI INCLUSI



Ref.

89324 1489,00 988,00



I PREZZI SI INTENDONO IVA ESCLUSA

BRAVO LASER ROTATIVO INCLIGRAD 2

- Laser rosso con doppia inclinazione +/- 10%
- Portata 500 m ϕ
- Funzione di scansione con 4 angoli e funzione TILT
- Calotta in metallo
- Ricevitore con indicazione millimetrica
- Precisione 1 mm / 10 m
- Ideale per la paesaggistica, i lavori di sbancamento, l'agricoltura, i parchi e i giardini
- Dimensioni 220 x 220 x 210 mm
- Pacco batteria NI-MH aggiuntivo (Ref. 60739)

ACCESSORI INCLUSI

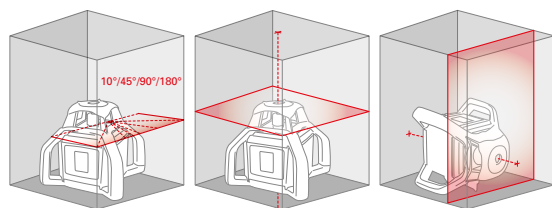
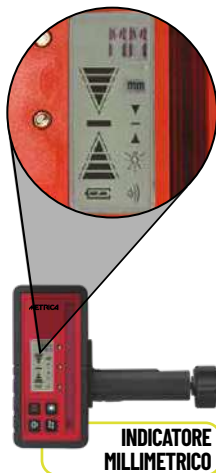

OMAGGIO
ZAINO
DARK BLU

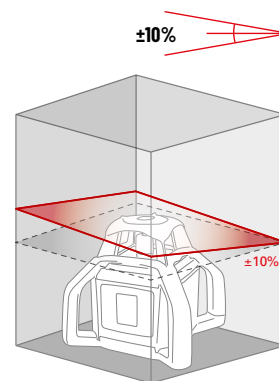

Ref. Portata

61345

Ø 500 m

1687,00

1120,00



KIT BRAVO LASER ROTATIVO INCLIGRAD 2

Composto da: Ref. 61345 - Ref. 60581 - Ref. 60621

Ref. 61345

ACCESSORI INCLUSI



Ref.

89316

1926,00

1310,00



+

Ref. 60581

ALTEZZA 95 ÷ 195 CM



+

Ref. 60621

ALTEZZA 2 M 40

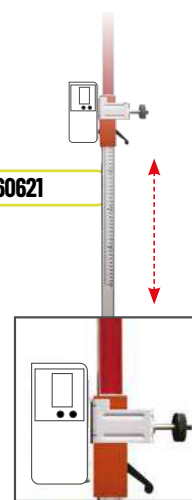

OMAGGIO

ZAINO
DARK BLU



I PREZZI SI INTENDONO IVA ESCLUSA

BRAVO LASER ROTATIVO INCLIGRAD 2 GREEN

- Laser verde a doppia pendenza +/- 10%
- Portata 500 m Ø
- Funzione di scansione con 4 angoli e funzione TILT
- Calotta in metallo
- Ricevitore con indicazione millimetrica
- Precisione 1 mm / 10 m
- Ideale per la paesaggistica, i lavori di sbancamento, l'agricoltura, i parchi e i giardini
- Dimensioni 220 x 220 x 210 mm
- Fornito con **batteria ricaricabile Li-ion** a lunga durata



OMAGGIO

ZAINO DARK BLU



TELECOMANDO GOMMATO INCLUSO

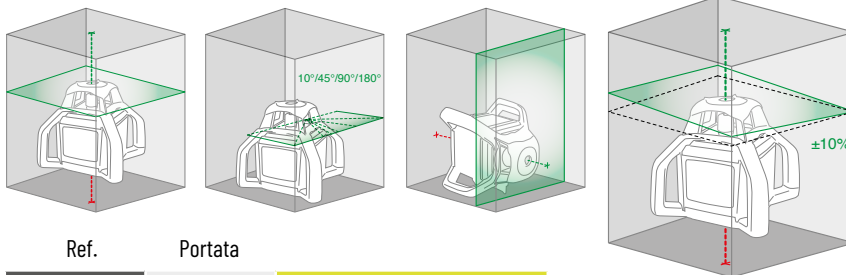

ACCESSORI INCLUSI

Ref.

Portata

61392

Ø 500 m

1850,00

1150,00

KIT BRAVO LASER ROTATIVO INCLIGRAD 2 GREEN

Composto da:

Ref. 61392 - Ref. 60581 - Ref. 60621



Ref. 61392



Ref. 60581

ALTEZZA 95 ÷ 195 CM

Ref. 60621

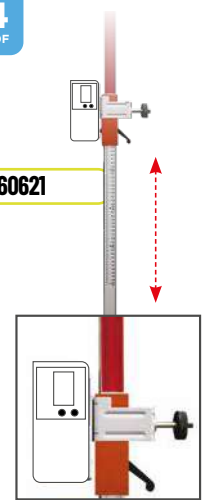

ALTEZZA 2 M 40

ACCESSORI INCLUSI



Ref.

89323

2089,00

1325,00



OMAGGIO

ZAINO DARK BLU



BRAVO LASER ROTATIVO INCLIGRAD 2 GREEN AUTO-TRACK

- Livella laser rossa a doppia inclinazione digitale +/- 10%
- Portata: 500 m Ø
- Funzione tilt & scanner su 4 angoli
- Coperchio in lega metallica
- **Ricevitore con indicazione MILLIMETRICA Ref. 61393**
- Altissima precisione: 1 mm / 10 m
- Ideale per paesaggisti, lavori di sterro, agricoltura, parchi e giardini, costruzione di strade, impianti edilizi

NEW

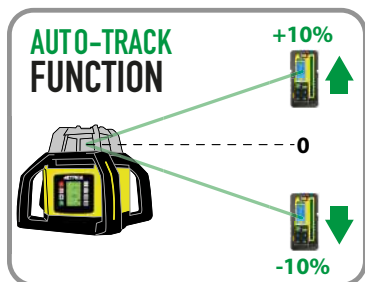

OMAGGIO
ZAINO
DARK BLU



AUTO-TRACK: Nuova funzione di allineamento del piano laser sul ricevitore

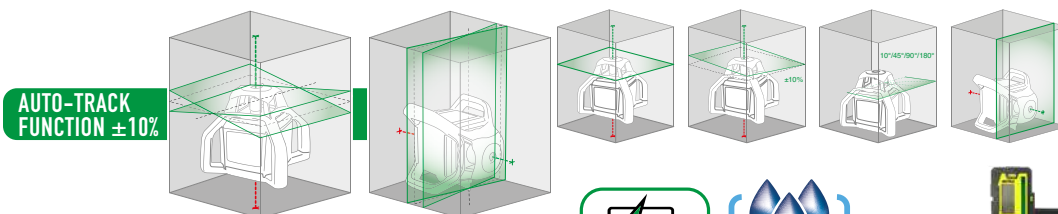

Ref.	Portata		
61792	Ø 500 m	1920,00	1235,00



KIT BRAVO LASER ROTATIVO INCLIGRAD 2 GREEN AUTO-TRACK

Composto da:
Ref. 61792 - Ref. 60581 - Ref. 60621

NEW



Ref. 61792

Ref. 60581

Ref. 60621



OMAGGIO
ZAINO
DARK BLU

Ref.		
89326	2159,00	1410,00

ACCESSORI INCLUSI



I PREZZI SI INTENDONO IVA ESCLUSA

KIT RICEVITORE CONTROLLO MOVIMENTO TERRA

ROSSO 
VERDE 

- Consente di controllare il livellamento del terreno con macchine movimento terra
- **Intercetta il segnale di qualsiasi laser rotativo a raggio rosso e verde**
- Lunghezza dell'asta ricevente 25 cm su un arco di 360°
- I diodi luminosi intercettano la linea laser
- Opzione doppia precisione
- Con caricabatterie da 220 V, cavo per la batteria del veicolo da 12 V, cavo di collegamento tra ricevitore e ricevitore remoto
- Durata della batteria ± 40 ore
- **Novità: pacchetto completo con morsetti + magneti**



ACCESSORI INCLUSI

COPIA DI MORSETTI REF. 60871



COPIA DI MAGNETI REF. 60872

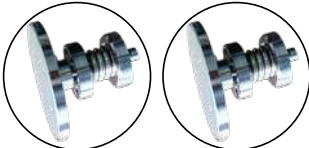

Ref.

60895 **1490,00** **1200,00**



MORSETTI

RICEVITORE

MONITOR DI CABINA



OMAGGIO



RICEVITORE PROFESSIONALE UNIVERSALE CON LETTURA IN MM

- **Nuovo modello universale compatibile con tutti i nostri laser rotativi, a raggio rosso e a raggio verde**
- Precisione: ± 1 mm (± 2 mm in modalità normale e ± 5 mm in modalità bassa)
- Campo di rilevamento molto ampio: 130 mm; indicazione millimetrica su 100 mm (± 50 mm)
- **Portata: 350 m**
- Dotato di potenti magneti sulla parte superiore e laterale del dispositivo

ROSSO 
VERDE 



Ref.

61701  **319,00** **275,00**

RICEVITORE PROFESSIONALE CON LETTURA IN MM

- **Capacità 350 m**
- **Precisione ±1 mm**
- Segnale: LED e segnale acustico
- Dotato di staffa di montaggio
- Compatibili con i nostri **laser rossi** rotativi (Ref. 61345, 61350, 61385)
- Compatibili con i nostri **laser verdi** rotativi (Ref. 61392, 61395, 61386)
- Sensibilità a 4 righe con lettura in mm/pollici



INCLUSO

REF. 61393
REF. 61396





REF. 61326
REF. 61328

Ref.

61326  mm **319,00** **256,00**
61393  mm **319,00** **256,00**

Ref.

61328  STD **194,00** **156,00**
61396  STD **194,00** **156,00**

I PREZZI SI INTENDONO IVA ESCLUSA

RICEVITORE DA ESTERNO PER LASER A PENDOLO

- Capacità 50 m
- Ref. 60748 compatibile con:
Ref. 61400M, 61405M, 61360, 61370, 60805
- Ref. 60749 compatibile con:
Ref. 61410M, 61415M, 61380, 61375, 61365, 61435, 61432, 60845, 61438, 61410MPLUS, 61415MPLUS



Ref.

60748	●	113,00	80,00
60749	●	128,00	101,00

SUPPORTO MAGNETICO PER LASER A PENDOLO

- Utilizzo possibile su: profili di max. 10 mm di metalli ferrosi, con perni/chiodi
- Compatibile con tutti i nostri livelli laser a croce e a linea.



Ref.

61342	59,60	45,00
-------	-------	-------



ASTA TELESCOPICA CON ASTA

- Supporto regolabile
- Con treppiede
- Per laser a croce e a linea in valigetta



Ref.

H

60560	3,6 m	108,00	79,00
-------	-------	--------	-------

ASTA TELESCOPICA

- Con fiala sferica
- In profilo di alluminio anodizzato
- In una custodia



Ref.

H

60621	2,4 m	83,00	60,00
-------	-------	-------	-------

MISURATORI TELESCOPICI IN ALLUMINIO

- Robusta sezione esagonale
- Bolla sferica
- In valigetta
- Ref. 49207 graduazione con "0" sulla parte inferiore



CON INDICAZIONE IN MM (RETTILINEO) E VERSO GEODETICO



Ref.

H

49204	4 m	52,00	38,00
49205	5 m	62,60	46,00
49207	7 m	78,00	59,00

I PREZZI SI INTENDONO IVA ESCLUSA

TREPIEDE A CREMAGLIERA 5/8"

- Robusto
- Con bolla di centraggio
- Regolazione dell'altezza con graduazione
- Treppiede con punzoni o protezione in gomma



Ref. H

60581	95 ÷ 195 cm	156,00	117,00
60582	112 ÷ 335 cm	185,00	143,00

TREPIEDE IN ALLUMINIO

- Molto stabile e solido
- Con bolla di centraggio
- Sollevamento a cremagliera
- Con borsa per il trasporto



5/8"



Ref. H

60585	63 ÷ 182 cm	84,60	64,00
-------	-------------	-------	-------

TREPIEDE IN ALLUMINIO

- Base piatta
- Adatto all'utilizzo con livelli ottici
- Sistema di bloccaggio rapido
- 97÷159 cm



5/8"



Ref. H

60498	97 ÷ 159 cm	83,60	62,00
-------	-------------	-------	-------

TREPIEDE IN ALLUMINIO

- Asta telescopica
- **Altezza elevata**
- Sollevamento a cremagliera
- Con borsa di trasporto
- 90÷290 cm



5/8"



Ref. H

60586	90 ÷ 290 cm	152,50	124,00
-------	-------------	--------	--------

TREPIEDE PROFESSIONALE CON SUPPORTO

- Elevazione a cremagliera graduata
- Apertura a raggiera
- Fiala di centraggio
- Piedini gommati
- In custodia a tracolla
- 97÷159 cm



1/4"



Ref. H

60596	97 ÷ 159 cm	51,60	44,00
-------	-------------	-------	-------

TREPIEDE ALL BLACK

- Treppiede in acciaio
- maniglia per trasporto,
- due fiale,
- piedi gommati/snodati per una migliore stabilità



1/4"



Ref. H

60599	53 ÷ 150 cm	25,50	23,50
-------	-------------	-------	-------

I PREZZI SI INTENDONO IVA ESCLUSA

KIT LIVELLO OTTICO 32X

- Composta da: Ref. 60466 - Ref. 60498 - Ref. 49024
- **Capacità 1000 m**
- **Zoom 32x**
- Asta telescopica da 4 m
- Smorzamento magnetico
- Treppiede da 1,59 m



Ref. 60466



Ref. 60498

ALTEZZA 97 ÷ 159 CM



Ref. 49204



Ref.	ZOOM		
89222	32X	375,50	250,00

MISURATORE STRADALE

- Capacità 10 Km
- Lettura: m/10 cm
- Ruota da 32 cm
- **Contatore visibile**
- **Maniglia pieghevole**
- Borsa per il trasporto



Ref.	Km		
60464	10	145,50	118,00

RILEVATORE 3 IN 1

- **Rilevatore di metalli, legno e cavi elettrici**
- Profondità di rilevamento fino a 8 cm per il metallo, 2 cm per il legno, 5 cm per i cavi elettrici
- Visualizzazione della profondità del punto centrale
- Funzione di rilevamento ad alta sensibilità
- Calibrazione automatica
- Schermo retroilluminato

CAVI ELETTRICI



LEGNO



FERRO



METALLI



Ref.			
61532	149 x 70 x 30 mm	114,50	71,00

I PREZZI SI INTENDONO IVA ESCLUSA

TERMOCAMERE FLIR C3-X, C5, C

- Consentono di rilevare fusibili surriscaldati, perdite di aria fredda, problemi idraulici.
- **Nuovo C8: campo visivo unico di 35° x 27°, precisione e sensibilità migliorate;**
- Streaming possibile. Immagine radiometrica: fino a 76.800 punti di misurazione/temperatura registrati automaticamente.
- Touchscreen intuitivo da 3,5".
- Funzione **MSX** (imaging multispettrale dinamico): combinazione di infrarossi e immagine reale
- Fotocamera visiva da 5 megapixel e flash LED
- Attacco per treppiede da 1/4"
- Ricerca automatica di punti caldi/freddi
- Memoria per 5000 immagini
- **IP54** e progettato per resistere a cadute da 2 metri
- Flir Ignite PRO con cloud gratuito
- Con custodia e cavo di ricarica USB-C



The Original



INFRARED GUIDED MEASUREMENT



Ref.		°C	Risoluzione	Pixel	
70823	C8	-20 à 450°	320 x 240	76.800	899,00
60395	C5	-20 à 400°	160 x 120	19.200	599,00
60393	C3-X	-20 à 300°	128 x 96	12.288	499,00

NEW



FLIR ONE EDGE / EDGE PRO

- Termocamere con connettività wireless per dispositivi mobili
- Risoluzione delle immagini termiche di 160 x 120 (19.200 pixel) per EDGE PRO e 80 x 60 (4.800) per EDGE
- Misura temperature fino a **400°C (EDGE PRO)** e 120°C (EDGE)
- Design robusto con durata della batteria fino a 1 ora e 30 minuti
- Funzione **MSX**
- Rilevamento automatico delle temperature più calde, più fredde e di tre temperature regolabili
- Identificazione e localizzazione di intrusioni di **umidità** e difetti di **isolamento**
- Risoluzione di problemi nelle ispezioni **AVAC/R**
- Identificazione di **difetti in componenti elettrici e meccanici**



Ref.		
60370	FLIR ONE EDGE	299,00
60378	FLIR ONE EDGE PRO	499,00
60379	CUSTODIA PER EDGE/EDGE PRO	30,00

The Original



INFRARED GUIDED MEASUREMENT



* se registrato entro 60 giorni dall'acquisto



OPTIONAL CUSTODIA REF. 60379

I PREZZI SI INTENDONO IVA ESCLUSA

2026 SELECTION

TERMOCAMERE SERIE PRO

- Modelli **PRO**
- Fotocamera digitale con risoluzione di 5 MP
- Risoluzione dello schermo 640 x 480
- Schermo da 3,5 pollici
- Livello e larghezza one-touch
- Design moderno e intuitivo del touchscreen
- Torcia a **LED** integrata
- Possibilità di aggiungere note dettagliate alle foto
- Nuova funzione 1-Touch: basta toccare lo schermo per selezionare un'area di messa a fuoco in un'immagine termica e la termocamera regola automaticamente il livello e la portata in base al contrasto termico
- Leggera (± 600 gr) ed estremamente robusta (resistente a cadute di 2 metri)
- Sovrapposizione di immagini **PIP**



INFRARED GUIDED MEASUREMENT



* se registrato entro 60 giorni dall'acquisto



Ref.		°C	Risoluzione IR	Sensibilità Termica	
60365	E5 PRO	-20 / 400	19.200 pixéis (160 x 120)	< 60 mk (<0,06 °C)	1199,00
60366	E6 PRO	-20 / 550	43.200 pixéis (240 x 180)	< 50 mk (< 0,05 °C)	1899,00
60368	E8 PRO	-20 / 550	76.800 pixéis (320 x 240)	< 40 mk (< 0,04 °C)	2799,00

CAMÉRA THERMIQUE FLIR TG268



- Ideale per applicazioni elettriche commerciali, meccaniche e automobilistiche
- Intervallo di misurazione fino a **400 °C**
- **Funzione MSX** e Bluetooth
- Fotocamera da 19.200 pixel
- Puntatore laser con mirino - Memoria: 50.000 immagini
- Batteria ricaricabile agli ioni di litio
- Resistente a cadute da 2 m
- Torcia LED integrata
- Fornito con termocoppia di tipo K, cinturino, cavo USB-C e custodia



INFRARED GUIDED MEASUREMENT



* se registrato entro 60 giorni dall'acquisto



Ref.		
70821	459,00	

CAMERA TERMICA TG165-X



- Campo di misura da -25 a +300 °C
- Funzione **MSX**
- **Memoria: 50.000 immagini**
- **Display LCD da 2,4**
- Batteria ricaricabile agli ioni di litio
- Resistente alle cadute da 2 m



INFRARED GUIDED MEASUREMENT



* se registrato entro 60 giorni dall'acquisto

Ref.		
60394	324,00	



1/4"

I PREZZI SI INTENDONO IVA ESCLUSA

IGROMETRO A PUNTA MR55

BLUETOOTH®



- Misurazioni possibili negli angoli e nelle aree scarsamente illuminate grazie alla luce di lavoro
- Display HD molto chiaro e leggibile
- Misura in 11 gruppi di materiali
- **Connessione Bluetooth® e compatibilità con l'applicazione FLIR Tools® Mobile**
- Compensazione automatica della temperatura ambiente



Ref.

60423

184,00



IGROMETRO A SONDA MR59

BLUETOOTH®



- Sensore sferico (senza punte) per misure non distruttive
- Misurazioni rapide su tutti i tipi di superfici, fino a 10 cm di profondità
- Misurazione negli angoli e in luoghi scarsamente illuminati grazie alla sua luce di lavoro
- Display HD molto chiaro e leggibile
- **Connessione Bluetooth® e compatibilità con l'applicazione FLIR Tools® Mobile**



Ref.

60425

269,00



DETECTOR DI VOLTAGGIO VP42

- **Lampada LED senza contatto (vibrazione), 60 lumen**
- 2 LED sulla punta
- Gamme di tensione da 190 a 1000 V e da 24 a 1000 V
- Dispositivo anticaduta 3 m



Ref.

70099

31,00



DETECTOR DI UMIDITÀ MR40

- Indicazioni acustiche di misurazione (5-12%, 13-60%, 60% e oltre)
- Display a cristalli liquidi illuminato
- Funzione di salvataggio delle misure
- Calibrazione e controllo dei picchi, integrati nel coperchio
- Torcia a LED 40 Lumen
- Dispositivo anticaduta 3 m



Ref.

70110

81,00



DOPPIO BOROSCOPIO VIDEO WIRELESS HD EXTECH BR450W-D

NEW

- Boroscopio video wireless HD BR450W-D è progettato per aiutarti a ispezionare e diagnosticare con chiarezza e precisione.
- Risoluzione HD 1280 x 720 e la telecamera a doppia visione da 5,5 mm su una sonda da 1,5 m consentono di acquisire facilmente immagini e video nitidi.
- App Extech ExView per trasmettere e controllare in modalità wireless il videoboroscopio. Con le viste affiancate dettagliate e registrazione multimediale, assicurati di disporre della documentazione necessaria per qualsiasi progetto.
- Alloggiamento robusto e leggero e il grado di protezione IP67
- Modello BR450W-D è perfetto per i controlli HVAC, le riparazioni automobilistiche e la manutenzione dell'impianto.



Ref.

73011

239,00



I PREZZI SI INTENDONO IVA ESCLUSA

2026 SELECTION

BLACK BULL



- Doppia graduazione
- Rigidità orizzontale di 4 m
- Nastro in acciaio testurizzato con rivestimento in nylon resistente all'abrasione
- Doppio gancio extra large per una migliore presa
- IL Magnete fissato al nastro **ELIMINA ERRORI DI MISURAZIONE**

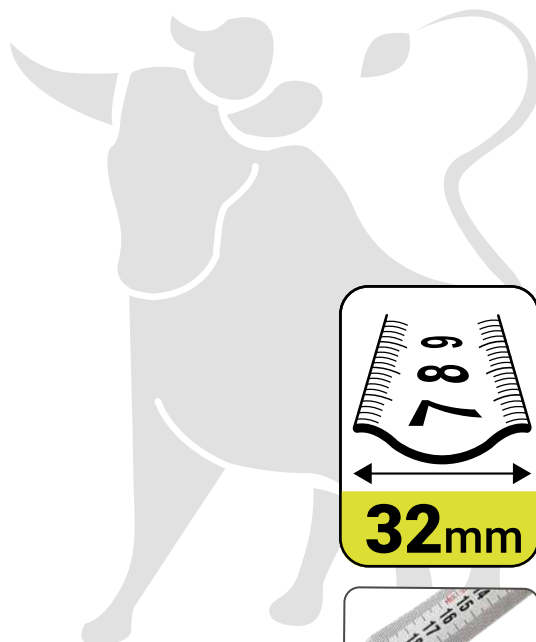

Ref.					
08075	5 m	32 mm	6	39,90	21,10
08078	8 m	32 mm	6	52,60	28,30

WING SHAPE

- Speciale forma a **W (Wing Shape)** per una maggiore rigidità orizzontale **i 3,5 m**
- **Nastro rivestito in nylon con copertura supplementare extra sui primi centimetri per una maggiore protezione**
- Doppia graduazione: numerazione orizzontale sul davanti con decimali gialli ad alta visibilità, numerazione verticale bianca sul retro con decimali rossi
- **Nastro autobloccante**
- Custodia in gomma ABS resistente agli urti



Ref.					
08037	5 m	32 mm	6	33,70	16,90
08038	8 m	32 mm	6	44,90	23,20

ESPOSITORE WING SHAPE
ESPOSITORE METALLO PROFESSIONAL

Ref.			
98069	08037	5 m	24
	08038	8 m	12

I PREZZI SI INTENDONO IVA ESCLUSA

BICOLOR

- Nastro brevettato con cambio di colore ogni 10 cm fino a 2 metri, per una visibilità immediata e semplice
- Larghezza del nastro aumentata per una maggiore stabilità (fino a 3 m in orizzontale con una larghezza di 28 mm)
- Numerazione ingrandita e ben visibile
- Custodia in ABS gommato antiurto - giallo fluorescente



CE II

Ref.					
08220	3 m	19 mm	12	11,80	7,50
08221	5 m	22 mm	12	16,70	10,50
08222	5 m	28 mm	6	19,20	12,00
08223	8 m	28 mm	6	28,00	17,50

Ref.

Ref.			
98068	08220	3 m	24
	08221	5 m	12
	08222	5 m	24
	08223	8 m	6

ESPOSITORE BICOLOR
ESPOSITORE METALLO PROFESSIONAL

ALL BLACK

- Autobloccante
- Tenuta orizzontale per oltre 2,5 m
- Spessore del nastro aumentato del 40%
- Doppia graduazione
- Superficie del nastro testurizzata resistente alla corrosione
- Rivestimento in nylon molto resistente
- Nastro nero e cifre bianche ultra-grandi per una facile leggibilità



CE II

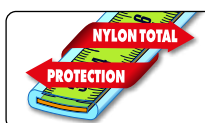

ZOOM 10X



FINITURA TESTURIZZATA
ELEVATA PROTEZIONE
RESISTENZA ALL'ABRAZIONE
10 VOLTE SUPERIORE



Ref.					
38143D	3 m	19 mm	24	17,50	8,80
38145D	5 m	25 mm	36	33,70	15,80
38148D	8 m	25 mm	12	46,00	21,00
38150D	10 m	25 mm	6	56,00	26,00

NEW

Ref.

Ref.			
98067	38143D	3 m	12
	38145D	5 m	24
	38148D	8 m	12

ESPOSITORE ALL BLACK
ESPOSITORE METALLO PROFESSIONAL

I PREZZI SI INTENDONO IVA ESCLUSA

XL 27 PLUS

- Nastro largo 27 mm
- Superficie del nastro testurizzata
- **Copertura in nylon più spessa**
- 10 volte più resistente all'abrasione

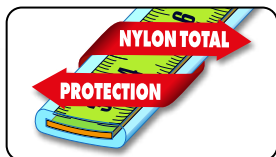

Con il primo ordine di 60 pz assortiti in OMAGGIO EXPO CUBE



ZOOM 10X



Ref.					
08765	5 m	27 mm	6	32,00	19,00
08768	8 m	27 mm	6	45,60	25,00

FLASH

- **Nastro con effetto fluorescente (parte anteriore)**
- Doppia graduazione
- Custodia gommata cromata
- Tocco di gomma
- Alta visibilità
- **Nastro rivestito in nylon e testurizzato**
- Forma ergonomica

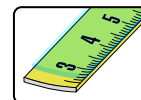

ZOOM 10X



Ref.					
08973	3 m	16 mm	12	17,60	9,50
08974	5 m	19 mm	12	25,10	13,90
08975	5 m	25 mm	12	28,30	15,80
08978	8 m	25 mm	12	38,40	21,00

ACTION CHROMED



Con il primo ordine di 60 pz assortiti in OMAGGIO EXPO CUBE



- Autobloccante
- **Magnete fisso: lettura senza errori**
- Doppia graduazione
- Cifre giganti



Ref.					
08212	3 m	16 mm	12	12,40	7,90
08214	5 m	19 mm	12	16,00	9,10
08215	5 m	25 mm	12	21,90	12,10
08218	8 m	25 mm	6	27,60	15,20

FLASH REVERXO

- **Nastro autobloccante**
- Graduazione su entrambe le facce: fronte numerazione orizzontale, retro numerazione verticale
- **Gancio doppia presa**
- Cassa gommata rubber touch
- Bottone dello stop di sicurezza/rilascio



Con il primo ordine di 60 pz assortiti in OMAGGIO EXPO CUBE



Ref.					
08103	3 m	16 mm	24	10,70	6,70
08104	5 m	19 mm	48	14,30	8,50
08105	5 m	25 mm	48	18,30	11,50
08108	8 m	25 mm	24	22,20	13,50

I PREZZI SI INTENDONO IVA ESCLUSA

CROMATO NYLON COATED

- Nastro largo 25 mm, **nylon coated**
- Elevata resistenza alla flessione, non flette fino a 3,50 m di altezza.
- **Numerazione gigante per una lettura facilitata.**
- Gancio mobile più alto



Con il primo ordine di 60 pz assortiti in OMAGGIO EXPO CUBE



CE II

Ref.	Icona	Icona			
08503	3 m	25 mm	24	13,70	6,00
08505	5 m	25 mm	48	16,40	7,50
08508	8 m	25 mm	24	20,30	9,80
08510	10 m	25 mm	6	23,50	12,50

FLASH TOUCH

- Custodia in bi-materiale
- Forma molto ergonomica
- Numerazione chiara e leggibile

CE II

Con il primo ordine di 60 pz assortiti in OMAGGIO EXPO CUBE



Ref.	Icona	Icona			
08963	3 m	16 mm	36	9,45	5,00
08964	5 m	19 mm	24	12,30	6,70
08965	5 m	25 mm	24	14,80	8,00
08968	8 m	25 mm	12	22,20	11,00
08970	10 m	25 mm	6	27,30	15,00

CROMATO

- Nastro largo 25 mm
- Elevata resistenza alla flessione: non flette fino a 3,50 m di altezza.
- **Numerazione gigante per una lettura facilitata.**
- Gancio mobile più alto

Con il primo ordine di 60 pz assortiti in OMAGGIO EXPO CUBE



CE II

Ref.	Icona	Icona			
38396	3 m	25 mm	24	10,80	6,00
38397	5 m	25 mm	48	13,60	7,50
38399	8 m	25 mm	24	17,40	9,70
38398	10 m	25 mm	12	22,00	12,20

RUBBER TOUCH

- **Nastro rivestito in nylon antiabrasione antiriflesso**
- Decimali rossi per una lettura facilitata.
- Cassa con superficie rivestita in gomma antiscivolo.

Con il primo ordine di 60 pz assortiti in OMAGGIO EXPO CUBE

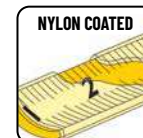

CE II

Ref.	Icona	Icona			
38793	3 m	16 mm	24	6,25	4,90
38794	5 m	19 mm	48	8,45	5,90
38795	5 m	25 mm	48	11,35	7,50
38798	8 m	25 mm	24	16,35	9,50

I PREZZI SI INTENDONO IVA ESCLUSA

3 STOP SERIE GIALLA NH

- Flessometro con cassa bimateriale
- 3 bottoni di bloccaggio



Con il primo ordine di 60 pz assortiti in OMAGGIO EXPO CUBE



CE II

Ref.				
38643NH	3 m x 16 mm	48	4,25	2,70
38645NH	5 m x 19 mm	48	6,40	4,10
38646NH	5 m x 25 mm	24	7,90	5,70
38648NH	8 m x 25 mm	6	12,20	8,10
38650NH	10 m x 25 mm	6	14,40	9,60

3 STOP SERIE ROSSA NH

- Flessometro con cassa bimateriale
- 3 bottoni di bloccaggio



Con il primo ordine di 60 pz assortiti in OMAGGIO EXPO CUBE



CE II

Ref.				
38653NH	3 m X 16 mm	48	4,25	2,70
38654NH	3 m X 19 mm	48	4,40	3,10
38655NH	5 m X 19 mm	48	6,40	4,10
38656NH	5 m X 25 mm	24	7,90	5,70
38658NH	8 m X 25 mm	6	12,20	8,10
38660NH	10 m X 25 mm	6	14,40	9,60

LOOK

- Cassa bimateriale
- Finestra di lettura per misure interne



Con il primo ordine di 60 pz assortiti in OMAGGIO EXPO CUBE



CE II

Ref.				
38264	3 m	16 mm	12	11,70 7,50
38265	5 m	19 mm	12	15,40 10,50

JUST IN 5M

- Finestra di lettura per misure interne



Con il primo ordine di 60 pz assortiti in OMAGGIO EXPO CUBE

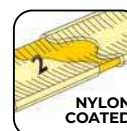

CE II

Ref.				
38206	5 m	19 mm	12	16,00 7,00

I PREZZI SI INTENDONO IVA ESCLUSA

TASCABILE GIALLO

- Cassa gialla in ABS, forma ergonomica con clip
- Bloccaggio e rientro automatico del nastro.
- Nastro smaltato opaco antiriflesso



Con il primo ordine di 60 pz assortiti in OMAGGIO EXPO CUBE



NEW

Ref.					
38362H	2 m	13 mm	60	2,90	1,90
38363H	3 m	16 mm	60	3,95	2,50
38365H	5 m	19 mm	48	5,80	4,20
38496H	5 m	25 mm	36	8,00	5,20
38497H	8 m	25 mm	24	12,70	8,30

CE II

TRANSPARENT

- Graduazione su due lati
- Numeri giganti

Ref.					
38751	● 3 m	16 mm	12	6,25	4,00
38761	● 3 m	16 mm	12	6,25	4,00
38771	● 3 m	16 mm	12	6,25	4,00
38754	● 5 m	19 mm	12	8,35	5,50
38764	● 5 m	19 mm	12	8,35	5,50
38774	● 5 m	19 mm	12	8,35	5,50

Ref.				
89780*	1	● ● ●		

* 89780 composto da 4x 38754, 4x 38764, 4x 38774



DOPPIA GRADUAZIONE

DISPLAY DA BANCO 12 PZ



CE II

MINI TRASPARENT 2 M

- Nastro bianco, colori assortiti, doppia graduazione (orizzontale + verticale)
- Cassa trasparente



DOUBLE GRADUATION

CE II

38031	●	2 m	13 mm	12	3,90	2,80
38032	●	2 m	13 mm	12	3,90	2,80
38033	●	2 m	13 mm	12	3,90	2,80

MINI 2M

Cassa in ABS, nastro bianco, colori assortiti



CE II

38028	○	2 m	13 mm	12	4,40	3,20
38029	●	2 m	13 mm	12	4,40	3,20
38030	●	2 m	13 mm	12	4,40	3,20

I PREZZI SI INTENDONO IVA ESCLUSA

SUPER ACTION - STEEL

- Esclusiva forma ergonomica brevettata
- Esclusivo sistema di estrazione del nastro a manovella bloccata
- Nastro in acciaio rivestito in nylon antiusura e anticorrosione
- Squadretta reclinabile di aggancio al nastro
- In valigetta



CE II



Ref.					
39242	50 m	13 mm	1	151,00	95,00

ROTELLA ACTION

- Nastro in acciaio smaltato rivestito in nylon antiusura e antiacido.
- Gancio a squadra all'inizio del nastro con anello in acciaio
- Impugnatura gommata con rivestimento antiscivolo.
- Sistema esclusivo di estrazione del nastro a manovella bloccata.



CE II



Ref.					
39270	50 m	13 mm	1	158,00	87,00

TENDERCOLOR

- Nastro in acciaio
- Numeri giganti
- Impugnatura gommata ergonomica



CE II



Ref.					
39262V	50 m	13 mm	1	60,00	33,00

NEW RUBBER TOUCH

- Corpo in ABS con effetto Rubber Touch
- Dimensioni e peso ridotti
- Nastro in acciaio smaltato
- Anello in metallo

CE II



Ref.					
39330	30 m	13 mm	1	55,20	34,00
39350	50 m	13 mm	1	92,40	57,00

I PREZZI SI INTENDONO IVA ESCLUSA

SUPER ACTION FIBRA

- Nastro in fibra di vetro
- Forma ergonomica unica (brevettata)
- **Nessun affaticamento** del polso durante il trasporto e la misurazione
- **Sistema esclusivo di uscita del nastro a manovella bloccata**
- Gancio pieghevole
- Impugnatura gommata antiscivolo



IMPUGNATURA GOMMATA ANTISCIVOLO



GANCIO A STAFFA PIEGHEVOLE



CON BORSA



Ref.



40029 50 m 13 mm 1 **70,00** 48,90

QUICK RETURN 100M - FIBRA

- Nastro in FIBRA
- **Forma ergonomica**
- Cassa traforata



RIAVVOLGIMENTO RAPIDO 3X



AMMORTIZZATORE E SQUADRA



Ref.



40027 100 m 13 mm 1 **92,40** 60,00

FORTE - FIBRA 19 mm

- Nastro in FIBRA **rinforzato con 50 fili**
- **3X** avvolgimento rapido
- Impugnatura in gomma antiscivolo



RIAVVOLGIMENTO RAPIDO 3X



GANCIO E ANELLO IN METALLO



CHIUSURA MAGNETICA



Ref.



40313 30 m **19 mm** 1 **49,60** 30,00
40315 50 m **19 mm** 1 **72,00** 41,00

QUICK-RETURN FIBERGLASS

- Esclusivo sistema di riavvolgimento rapido 3X a velocità triplicata
- Sistema ammortizzatore del nastro a fine corsa
- Impugnatura con rivestimento gommato antiscivolo
- Custodia a struttura aperta per una maggiore pulizia del nastro



CON BORSA



RIAVVOLGIMENTO RAPIDO 3X



Ref.



40023 30 m 13 mm 1 **45,10** 30,50
40025 50 m 13 mm 1 **57,80** 37,00

I PREZZI SI INTENDONO IVA ESCLUSA

TAPPO SPORGENTE ANTISCIVOLO



Ref.	●	☐	📦		
33130	30 cm	3		24,10	15,20
33134	40 cm	3		25,40	16,00
33135	50 cm	3		29,10	18,50
33136	60 cm	3		32,00	20,10
33138	80 cm	1		38,10	24,00
33140	100 cm	1		44,00	28,00
33141	120 cm	1		51,60	32,40
33142	150 cm	1		56,80	35,90
33145	180 cm	1		63,40	39,50
33150	200 cm	1		74,00	46,10

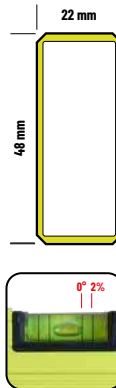

NUOVO TAPPO SPORGENTE IN GOMMA

FLASH

- Precisione 0,5 mm/m



ESPOSITORE PER LIVELLE ESPOSITORE DA 30 LIVELLE FLASH

Ref.			📦
98080	33134	40 cm	6
	33135	50 cm	6
	33136	60 cm	6
	33138	80 cm	6
	33140	100 cm	6

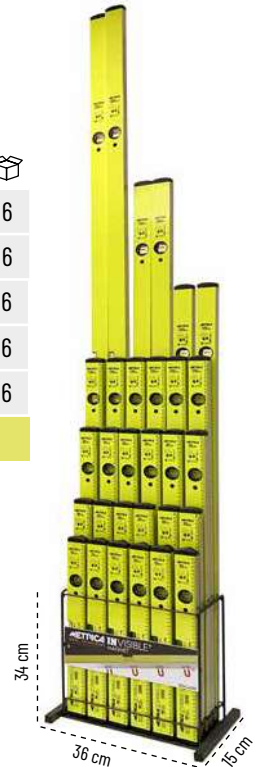

FLASH XL

LIVELLE IN ALLUMINIO

- Precisione 0,3 mm/m
- Due basi fresate (fino a 120 cm)
- Tappi in gomma



Ref.	●	☐	📦		
33164	40 cm	3		39,30	25,08
33165	50 cm	3		45,20	28,30
33166	60 cm	3		49,90	31,50
33168	80 cm	1		57,60	36,80
33170	100 cm	1		63,60	40,40
33172	120 cm	1		74,50	46,20
33175	150 cm	1		80,60	49,40
33178	180 cm	1		89,00	58,00
33180	200 cm	1		101,00	65,00

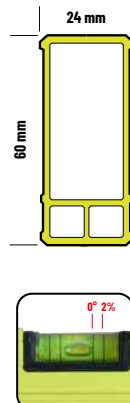

ESPOSITORE PER LIVELLE ESPOSITORE DA 30 LIVELLE FLASH XL

Ref.			📦
98084	33164	40 cm	6
	33165	50 cm	6
	33166	60 cm	6
	33168	80 cm	3
	33170	100 cm	3
	33172	120 cm	2
	33175	150 cm	2
	33180	200 cm	2



I PREZZI SI INTENDONO IVA ESCLUSA

NUOVO

TAPPO SPORGENTE IN GOMMA

megalevel **IN**VISIBLE

- Magneti forti e invisibili incorporati
- Precisione: 0,5 mm/m
- Base fresata
- Magneti forti e invisibili incorporati
- Precisione: 0,5 mm/m



TAPPO
NORMALE

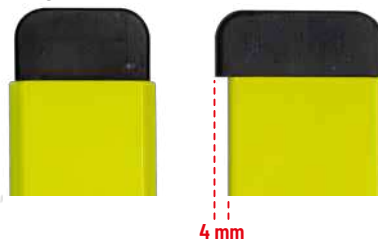

ESPOSITORE PER LIVELLE ESPOSITORE DA 30 LIVELLE MEGA INVISIBLE

Ref.

Ref.	Cap	U	cm	6
98081	32224	U	40 cm	6
	32225	U	50 cm	6
	32226	U	60 cm	6
	32228	U	80 cm	6
	32230	U	100 cm	2
	32365	U	150 cm	2
	32370	U	200 cm	2

Ref.	Cap	U	cm	3	42,60	30,00
32224	40 cm	3				
32225	50 cm	3				
32226	60 cm	3				
32228	80 cm	1				
32230	100 cm	1				
32232	120 cm	1				
32365	150 cm	1				
32368	180 cm	1				
32370	200 cm	1				

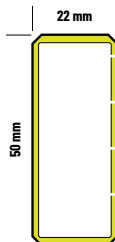

BASE FRESATA
CON MAGNETI
INVISIBILI

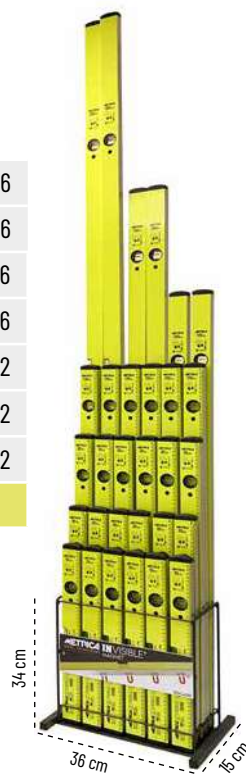

formula **IN**VISIBLE

- Base fresata



OMAGGIO
METAL BODY
09066 1pz



ESPOSITORE PER LIVELLE ESPOSITORE DA 30 LIVELLE FORMULA INVISIBLE

Ref.

Ref.	Cap	U	cm	6
98083	32834	U	40 cm	6
	32835	U	50 cm	6
	32836	U	60 cm	6
	32838	U	80 cm	3
	32840	U	100 cm	3
	32842	U	120 cm	2
	32837	U	150 cm	2
	32841	U	200 cm	2

Ref.	Cap	U	cm	3	53,60	34,00
32834	40 cm	3				
32835	50 cm	3				
32836	60 cm	3				
32838	80 cm	1				
32840	100 cm	1				
32842	120 cm	1				
32837	150 cm	1				
32839	180 cm	1				
32841	200 cm	1				

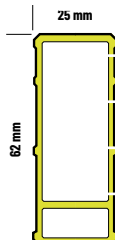

BASE FRESATA CON
MAGNETI
INVISIBILI



I PREZZI SI INTENDONO IVA ESCLUSA

FLASH XL

- Precisione 0,3 mm/m
- Con maniglie
- Base fresata

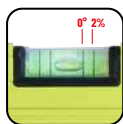

OMAGGIO
OPEN&CUT
09068 1pz



DOPPIA BASE
FRESATA FINO
A 120 CM

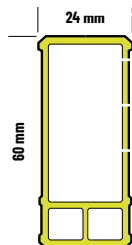

ESPOSITORE PER LIVELLE ESPOSITORE DA 30 LIVELLE FLASH XL 0,3 mm

Ref.

98082	33185	50 cm	6
	33186	60 cm	6
	33182	80 cm	6
	33183	100 cm	6
	33212	120 cm	2
	33218	180 cm	2
	33220	200 cm	2



Ref.	Length	Qty	Price 1	Price 2
33185	50 cm	1	53,60	32,50
33186	60 cm	1	57,00	34,50
33182	80 cm	1	67,00	40,50
33183	100 cm	1	74,50	45,00

Ref.	Length	Qty	Price 1	Price 2
33212	120 cm	1	97,00	58,50
33215	150 cm	1	104,00	62,50
33218	180 cm	1	116,00	70,00
33220	200 cm	1	134,00	80,50

LIVELLE TRAPEZIA IN ALLUMINIO

- Molto robuste: realizzate in solida fusione di alluminio
- Alta resistenza
- Fiale acriliche
- Base fresata



BASE MAGNETICA



Ref.	Length	Qty	Price 1	Price 2
31072	25 cm	6	27,50	17,60
31073	30 cm	6	27,60	17,70
31074	40 cm	6	30,40	19,60
31075	50 cm	6	34,20	21,90
31076	60 cm	6	37,40	23,80
31078	80 cm	3	65,60	41,70
31080	100 cm	3	86,60	55,00

Ref.	Shape	Length	Qty	Price 1	Price 2
31062	U	25 cm	6	39,20	24,90
31063	U	30 cm	6	39,70	25,20
31064	U	40 cm	6	40,50	25,90
31065	U	50 cm	6	49,10	31,20
31066	U	60 cm	3	53,20	33,90

STAGGE IN ALLUMINIO

- Staggia in alluminio profilato.
- Due fiale acriliche resistenti agli urti
- Garanzia 2 anni, due impugnature.
- Grande sezione: 100 x 18 mm



Ref.	Length	Qty	Price 1	Price 2
32671	150 cm	5	70,40	40,00
32672	180 cm	5	73,00	40,80
32673	200 cm	5	85,80	46,00

Ref.	Length	Qty	Price 1	Price 2
32674	250 cm	5	94,40	51,00
32675	300 cm	5	113,00	60,00

I PREZZI SI INTENDONO IVA ESCLUSA

LIVELLE PER ELETTRICISTI 20 CM

- Due fiale acriliche resistenti agli urti
- **Anodizzata nera**
- **Disponibile anche in versione con magneti invisibile**
- Base fresata

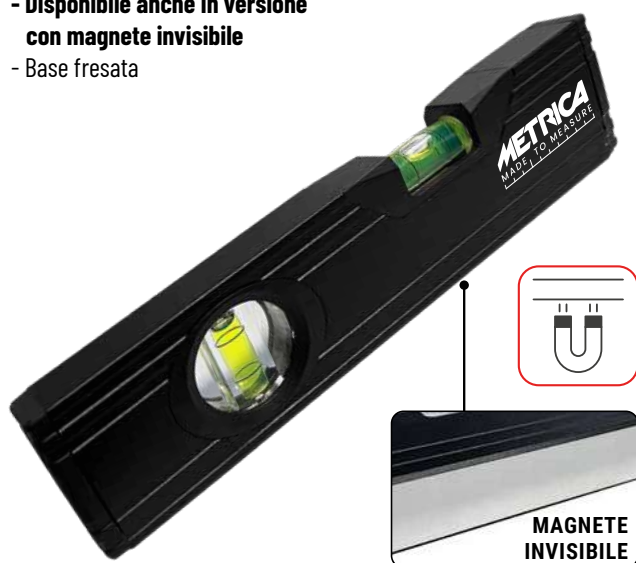

Ref.					
31028		20 cm	1	16,30	9,00
31029	U	20 cm	1	29,40	16,50

LIVELLA TASCABILE

- Livella tascabile in ABS, tre fiale con base magnetica.
- **Minilivella asportabile per fili**

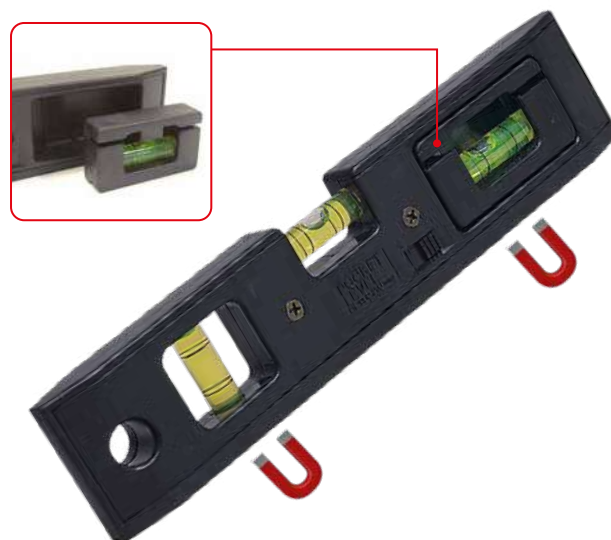

Ref.					
33001		21 cm	10	11,90	6,00

LIVELLA TASCABILE 10 CM

- Livella tascabile in ABS, con base magnetica.
- Box da 12pz



Ref.					
31027	12			14,50	9,80

LIVELLA PLEXIGLASS TRASPARENTE

- Livella plexiglass trasparente a 2 fiale
- **100 mm x 50 mm**



Ref.					
33036	1			20,20	12,50

I PREZZI SI INTENDONO IVA ESCLUSA

telefix®

MADE IN ITALY

- Misuratore telescopico professionale a
- **LETTURA DIRETTA SU NASTRO GRADUATO**
- **Indicazione di misure interne ed esterne.**
- Dispositivo di misura all'estremità superiore dello strumento per una lettura facilitata.
- **Base a tenuta stagna con guaina impermeabile (brevettata).**
- Bloccaggio automatico di ogni asta a fine corsa

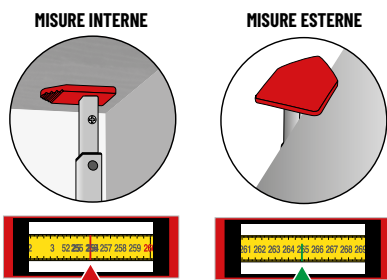

La linea rossa indica la misura interna

La linea verde indica la misura esterna

Ref.				
49358	1 m	32 cm	230,00	205,00
49359	2 m	49 cm	245,00	215,00
49360	3 m	66 cm	260,00	225,00
49361	4 m	83 cm	285,00	240,00
49362	5 m	99 cm	310,00	289,00
49363	6 m	116 cm	365,00	335,00
49365	8 m	135 cm	510,00	457,00
49366	10 m	163 cm	610,00	535,00

TELEFIX PER SERRAMENTISTI

- Misuratore telescopico professionale a **LETTURA DIRETTA SU NASTRO GRADUATO** con indicazione di misure interne ed esterne
- Finestrella di misura posizionata nella parte inferiore per facilitare la lettura in caso di misurazione dei serramenti.



Ref.				
49364	3 m	66 cm	260,00	227,00



telefix® PLUS

MADE IN ITALY

- **Più robusto, più rigido, migliore visibilità**
- Utilizzabile con braccio telescopico e accessori (non inclusi)

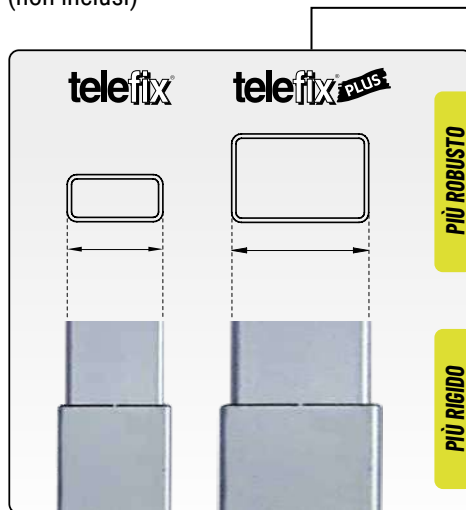

NUOVO NASTRO A LETTURA VERTICALE

OMAGGIO



TELEFIX PLUS

Ref.	L		
49347	5 m	118 - 500 cm	325,00 299,00
49348	6 m	138 - 600 cm	380,00 355,00
49349	8 m	153 - 800 cm	530,00 468,00



* Brevettato L'utilizzo di accessori invalida automaticamente la certificazione CE.

TELEFIX PLUS con asta telescopica (Ref. 49321)

Ref.	L		
49337	5 m	118 - 500 cm	465,00 393,00
49338	6 m	138 - 600 cm	520,00 450,00
49339	8 m	153 - 800 cm	670,00 564,00

ASTA TELESCOPICA in alluminio

Ref.			
49321	140 - 250 cm	140,00	90,00

I PREZZI SI INTENDONO IVA ESCLUSA

telefix

TELEFIX DIGITAL LASER



- Misuratore laser telescopico digitale
- **Letture dirette con indicazione delle misure INTERNE ed ESTERNE**
- Base impermeabile con guaina impermeabile
- Blocco automatico di ciascuna asta a fine corsa grazie a molle interne in acciaio inossidabile
- Fiala circolare per un corretto posizionamento
- 1 batteria al litio ricaricabile tramite USB-C
- Custodia con maniglia per il trasporto

ACCESSORI



ACCESSORI SU RICHIESTA

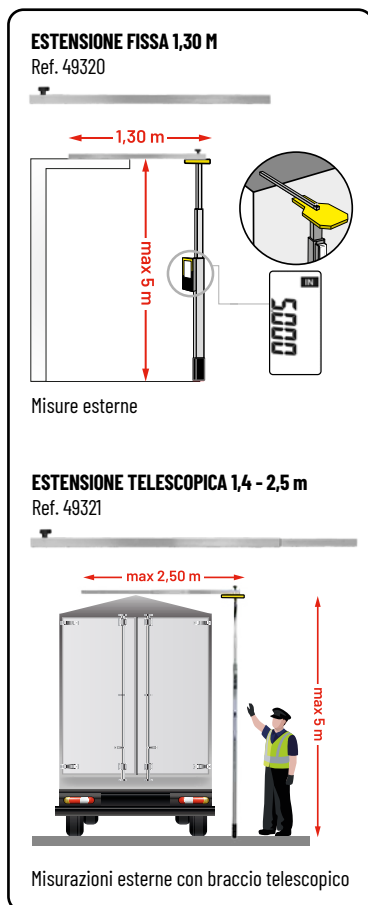

NEW

MISURAZIONI

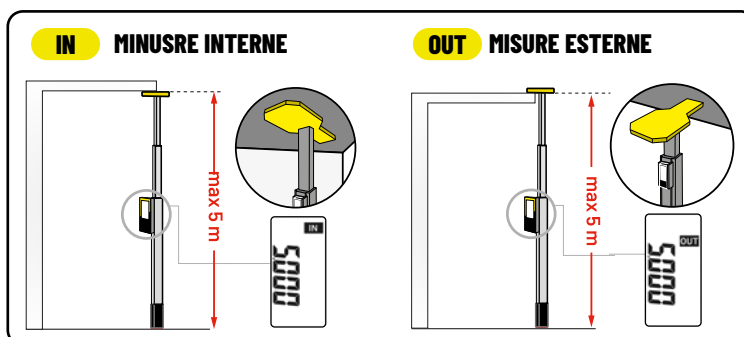

TELEFIX LASER

Ref.	L		
49325	5 m	140 - 500 cm	310,00 280,00

REF. 49320 - ESTENSIONE FISSA REF. 49321 - ESTENSIONE TELESCOPICA

Ref.	L		
49320	1,3 m		70,00 45,00
49321	1,4 - 2,5 m		140,00 90,00

REF. 49322 - KIT ESTENSIONE FISSA (Ref. 49325 + Ref. 49320) REF. 49323 - KIT ESTENSIONE TELESCOPICA (Ref. 49325 + Ref. 49321)

Ref.	L		
49322	5 m	1,3 m	380,00 345,00
49323	5 m	1,4 - 2,5 m	450,00 393,00

I PREZZI SI INTENDONO IVA ESCLUSA

quadranfix



MADE IN ITALY

Con bracci a incastro

Ref.				
29900	45 cm	1	259,00	252,00
29901	60 cm	1	267,00	260,00
29903	75 cm	1	289,00	280,00
29902	100 cm	1	310,00	301,00
29904	150 cm	1	370,00	360,00

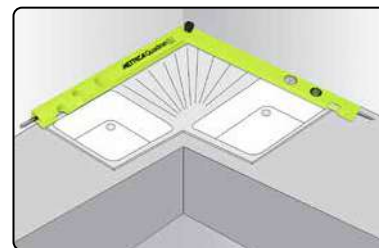

Con bracci affiancati

Ref.				
29905	60 cm	1	290,00	285,00



Con bracci affiancati e base calamitata

Ref.				
29915	60 cm	1	310,00	301,00



REF. 29915

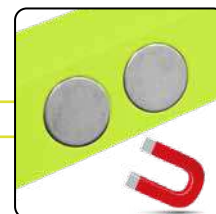

2 FIALE
ACRILICHE



QUADRANTE:
0°-90° E
90°-180°



BLOCCAGGIO
A VITE



I PREZZI SI INTENDONO IVA ESCLUSA

LIVELLA DIGITALE incligrad

- Lettura digitale di gradi e percentuali
- Display illuminato
- Pulsante di blocco

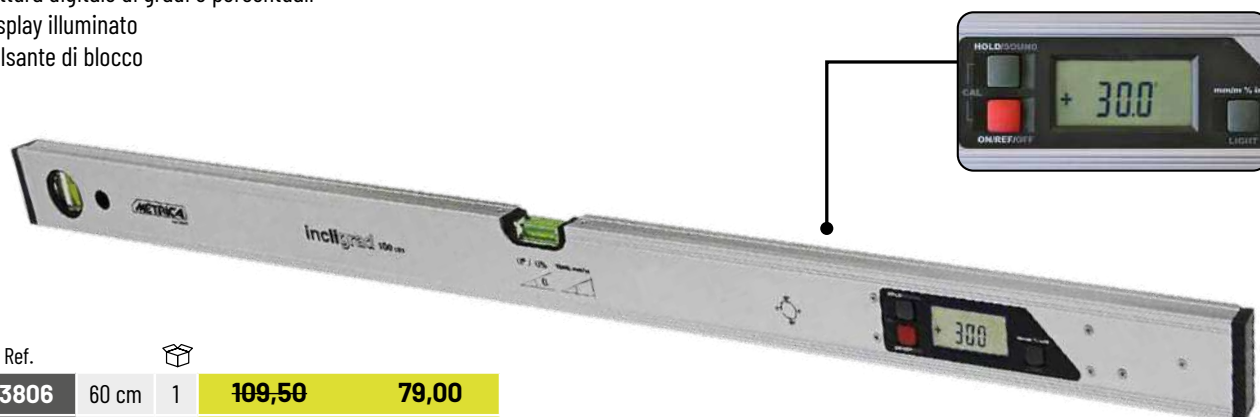

Ref.				
33806	60 cm	1	109,50	79,00
33810	100 cm	1	126,00	95,00

MISURATORE DIGITALE digigrad DI ANGOLI

0° - 225°

- Lettura digitale 0,05°
- Display illuminato
- Bloccabile
- 0-225°



Ref.				
29890	50 cm	1	182,00	138,00

MINI INCLIGRAD

- Lettura digitale di gradi e %
- Misura 4x90°
- Precisione ± 0,2°
- Display retro illuminato
- Rotazione schermo a 180°
- Batterie Li-ion ricaricabili tramite USB-C
- 4 lati calamitati

DISPLAY BOX
5 PZ

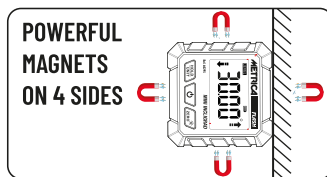
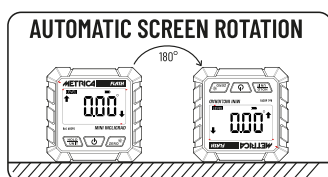

Ref.				
60295	50 cm	1	59,00	49,30

I PREZZI SI INTENDONO IVA ESCLUSA

METRO A STECCA IN LEGNO SEMIGIGANTE

- Metro a stecca professionale in legno, perni visibili, spessore 3mm
- Molle interne in acciaio temprato con scatto a 90° resistenti all'usura.
- Doppia graduazione, numeri decimali neri, laccato bianco / giallo o naturale



Ref.					CE	III
23080	●	2 m	30	7,75	5,60	
23090	●	2 m	30	7,75	5,60	

ESPOSITORE METRI A STECCA

ESPOSITORE DA 50 PZ



Ref.		
89090	1	
89091	1	

METRO A STECCA IN LEGNO

- Metro a stecca professionale in legno laccato
- PERNI invisibili, doppia graduazione con decimali neri
- Rigido fino a 2 m in orizzontale e verticale
- Modello professionale - in betulla
- Laccato bianco / giallo o bianco

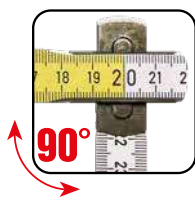
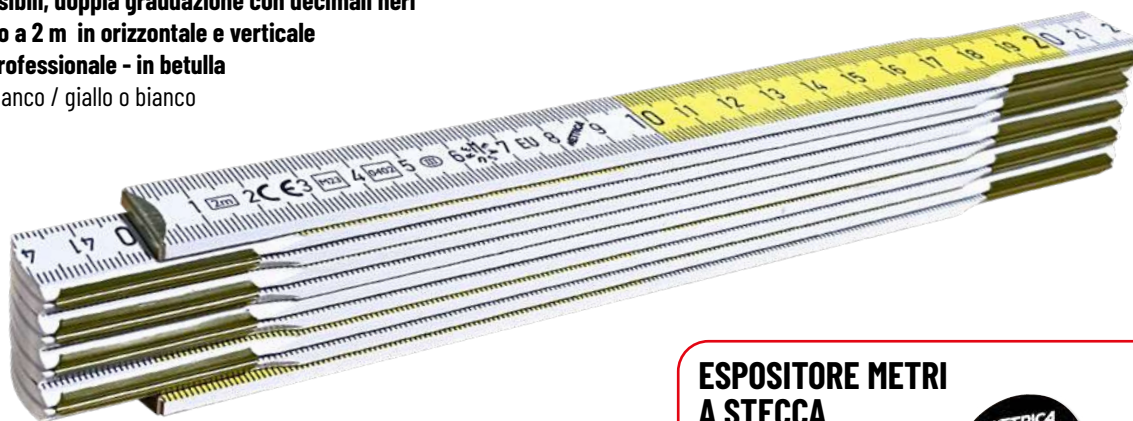

Ref.					CE	III
23085H	●	2 m	30	6,40	4,10	
23087H	○	2 m	30	6,40	4,10	

ESPOSITORE METRI A STECCA

ESPOSITORE DA 50 PZ PER REF. 23085H



Ref.		
89051	1	

I PREZZI SI INTENDONO IVA ESCLUSA

METRO A STECCA IN FIBRA DI VETRO

- Graduazione incisa
- **Snodi con doppia molla antiusura e scatto a 90°**
- Non conduttore, lavabile, non graffia la superficie

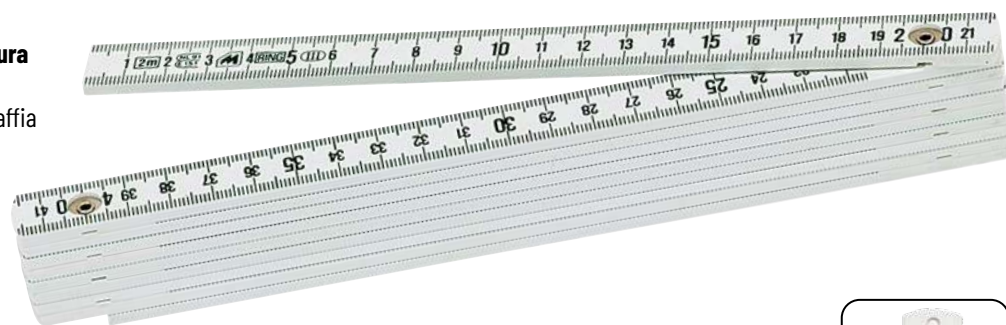

Ref.					
18010	○	2 m	30	9,20	3,90
18020	●	2 m	30	9,20	3,90



METRO A STECCA IN FIBRA DI VETRO A LETTURA FACILITATA

- Metro a stecca con graduazione a tratti di lunghezza variabile **ogni 2 mm per una lettura facilitata (design registrato)**.
- Graduazione incisa, snodi con doppia molla antiusura e scatto a 90°.
- Non conduttore, lavabile, non graffia le superfici.

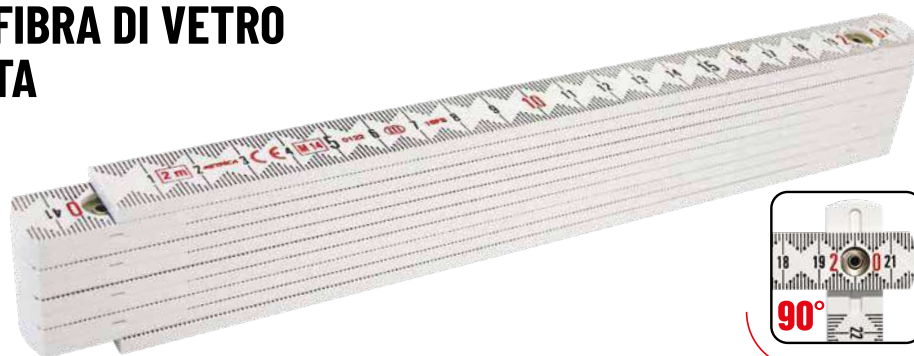

EASY READING



Ref.					
18019		2 m	12	10,60	4,70



1 METRO - 2 METRI - DURALLUMINIO GRADUAZIONE INDELEBILE

- In duralluminio nero
- **Graduazione ossidata indelebile**
- Molle trattate in ottone



Ref.					
20108		1 m	12	12,30	8,60
21036		2 m	12	23,70	15,90



I PREZZI SI INTENDONO IVA ESCLUSA

CUTTER UTILITY

- Lama "ALL BLACK" 0,6 mm SK2
- Regolabile in 3 posizioni e pieghevole (solo 11 cm quando è chiuso)
- Con clip per cintura
- Corpo in metallo in colore Flash, facile da vedere in cantiere
- Spelafili
- Facile sostituzione della lama
- Lama 19 X 0,6 mm

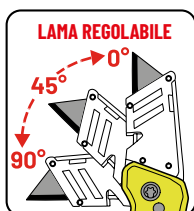

Ref.



09080

L 175 mm / 115 mm

12

19,30

13,80

LAME

- Confezione da 10
- Lama 19 X 0,6 mm

0,6 mm

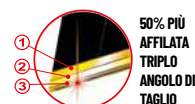

50% PIÙ AFFILATA
TRIPLIO
ANGOLO DI
TAGLIO

sk2
HRC ≥ 67



Ref.



49043

59 x 19 x 0,6 mm

10

4,10

2,80

CUTTER ONE 1 MM

- Lama All Black One, spessore maggiorato da 1 mm SK2
- Corpo in ABS
- Blocco automatico della lama
- Lama 18 X 1 mm



**BOTTONE
CAMBIO
LAMA**



1.0 mm
SPESSORE
LAMA

sk2
HRC ≥ 67



**LAME DI
RICAMBIO
INCLUDE**

Ref.



09036

L 140 mm

12

18,30

13,50

LAME

- Confezione da 7
- Lama 18 X 1 mm

1 mm

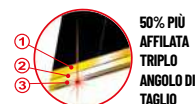
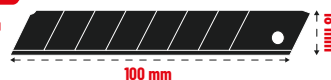

50% PIÙ AFFILATA
TRIPLIO
ANGOLO DI
TAGLIO

sk2
HRC ≥ 67



Ref.



49068

100 x 18 x 1 mm

12

7,90

4,90

CUTTER CON VITE DI BLOCCAGGIO

- Corpo in alluminio
- Lama 9 x 0,6 mm



sk2
HRC ≥ 67



Ref.



09069

L 140 mm

12

10,20

7,60

LAME

- Confezione da 10
- Lama 9 X 0,6 mm

0,6 mm

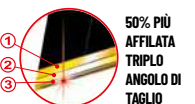

50% PIÙ AFFILATA
TRIPLIO
ANGOLO DI
TAGLIO

sk2
HRC ≥ 67



Ref.



49029

80 x 9 x 0,6 mm

10

4,90

2,70

I PREZZI SI INTENDONO IVA ESCLUSA

CUTTER BLACK BLADE METAL BODY

- Corpo in **metallo**
- Lama 9 x **0,4** mm
- Con clip



sk2
HRC ≥ 67

OMAGGIO
EXPO CUBE
con il primo
ordine di
36 pz assortiti



CON CLIP



Ref.

09066

L 140 mm



24

5,10

2,80

LAME

- Confezione da 10
- Lama 9 X **0,4** mm

0,4 mm

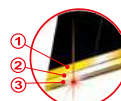

50% PIÙ
AFFILATA
TRIPLO
ANGOLO DI
TAGLIO

sk2
HRC ≥ 67



Ref.

49067

85 x 9 x **0,4** mm



10

3,30

2,10

CUTTER "ALL BLACK"

- Corpo in **ABS**
- Lama 18 x **0,7** mm



sk2
HRC ≥ 67

OMAGGIO
EXPO CUBE
con il primo
ordine di
36 pz assortiti



Ref.

09031

L 160 mm



12

8,00

5,40

LAME

- Confezione da 10
- Lama 18 X **0,7** mm

0,7 mm

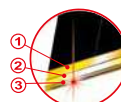

50% PIÙ
AFFILATA
TRIPLO
ANGOLO DI
TAGLIO

sk2
HRC ≥ 67



Ref.

49058

100 x 18 x **0,7** mm



10

10,10

6,00

CUTTER "ALL BLACK" CON VITE DI BLOCCAGGIO

- Corpo in **ABS**
- Lama 18 x **0,7** mm
- **PROFESSIONALE**



sk2
HRC ≥ 67

OMAGGIO
EXPO CUBE
con il primo
ordine di
36 pz assortiti



**SELF
LOCKING
FORCE**

60kg



Ref.

09033

L 185 mm



12

12,20

8,40

LAME

- Confezione da 10
- Lama 18 X **0,7** mm

0,7 mm

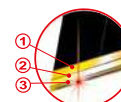

50% PIÙ
AFFILATA
TRIPLO
ANGOLO DI
TAGLIO

sk2
HRC ≥ 67



Ref.

49058

100 x 18 x **0,7** mm



10

10,10

6,00

I PREZZI SI INTENDONO IVA ESCLUSA

CUTTER "ALL BLACK" CON VITE DI BLOCCAGGIO

- Corpo in metallo
- Impugnatura antiscivolo
- Lame 18 x 0,7 mm
- PROFESSIONALE
- ALTAMENTE RESISTENTE



sk2
HRC ≥ 67

OMAGGIO
EXPO CUBE
con il primo
ordine di
36 pz assortiti



60kg
SELF
LOCKING
FORCE



Ref.



09039

L 185 mm

12

17,80

12,30

LAME

- Confezione da 10
- Lame 18 X 0,7 mm

0,7mm

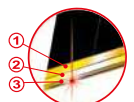

50% PIÙ
AFFILATA
TRIPLA
ANGOLO DI
TAGLIO

sk2
HRC ≥ 67



Ref.



49058

100 x 18 x 0,7 mm

10

10,10

6,00

CUTTER BLACK BLADE TASCABILE 18 MM "ZEBRA"

- Corpo in ABS
- Lame 18 x 0,7 mm



sk2
HRC ≥ 67

OMAGGIO
EXPO CUBE
con il primo
ordine di
36 pz assortiti



Ref.



09025

L 140 mm

12

7,65

5,50

LAME

- Confezione da 10
- Lame 18 X 0,7 mm

0,7mm



50% PIÙ
AFFILATA
TRIPLA
ANGOLO DI
TAGLIO

sk2
HRC ≥ 67



Ref.



49064

80 x 18 x 0,7 mm

10

7,15

4,70

BLACK BULL 25 MM CON VITE DI BLOCCAGGIO

- Lame 25 x 0,7 mm
- PROFESSIONALE
- ALTAMENTE RESISTENTE

sk2
HRC ≥ 67



OMAGGIO
EXPO CUBE
con il primo
ordine di
36 pz assortiti



60kg
SELF
LOCKING
FORCE



Ref.



09037

L 160 mm

12

21,50

15,30

LAME

- Confezione da 10
- Lame 25 X 0,7 mm

0,7mm

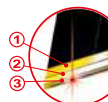

50% PIÙ
AFFILATA
TRIPLA
ANGOLO DI
TAGLIO

sk2
HRC ≥ 67



Ref.



49039

126 x 25 x 0,7 mm

12

13,50

9,50

I PREZZI SI INTENDONO IVA ESCLUSA

CUTTER BLACK BLADE OPEN&CUT

- Corpo in ABS
- Lama 18 x 0,7 mm SK2



OPEN & CUT



sk2
HRC ≥ 67

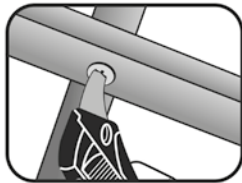

VITI

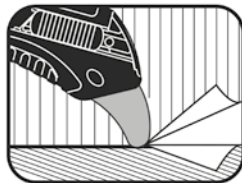

MOQUETTE



LAME

Confezione da 10
lame 18 X 0,7 mm

0,7 mm



- 1
 - 2
 - 3
- 50% PIÙ
AFFILATA
TRIPLO
ANGOLO
DI TAGLIO

sk2
HRC ≥ 67



Ref.					
09068	L 170 mm	12	10,10	7,20	

Ref.					
49058	100 x 18 x 0,7 mm	10	10,10	6,00	

SET CUTTER SK4 ULTRA SHARP

- Corpo in ABS
- Bloccaggio della lama automatico
- Espositore da banco - 24 pz



Ref. 49065

sk4
HRC ≥ 65

BOTTONE
CAMBIO
LAMA



BOX BLACK BLADE ULTRA SHARP

Confezione da 24 pz



Ref.					
49065	L 160 mm	24	4,00	2,90	

Ref.					
89365	175 x 165 x 165 mm	1			

ESPOSITORE CUTTER ALL BLACK

- Nuovo espositore in metallo da banco per cutter ALL BLACK



Modello A		
89363	09031	12
	49058	10
	09069	12
	49029	10
	09036	12
	49068	12
	09080	12
	49043	10

Modello B		
89364	09033	12
	49058	10
	09037	12
	49039	12
	09025	12
	49064	10
	09068	12
	49058	10

I PREZZI SI INTENDONO IVA ESCLUSA

MARCATORE SPRAY FOLLOW ME 500ML

- Marcatore spray da cantiere
- Tappo di chiusura di sicurezza
- Valvola autopulente
- Colori fluorescenti non permanenti senza piombo e senza CFC
- Per marcare qualsiasi superficie, anche bagnata (cemento, asfalto, pietra, erba, sabbia, ecc.)

Ref.					
50181EU	●	12	9,95	5,50	
50182EU	●	12	9,95	5,50	
50183EU	●	12	9,95	5,50	
50184EU	●	12	9,95	5,50	
50185EU	●	12	9,95	5,50	
50186EU	●	12	9,95	5,50	

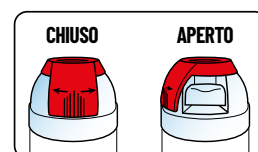
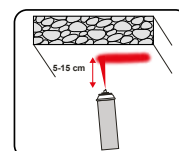
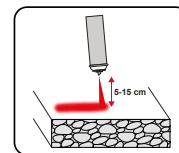
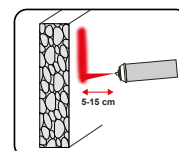

NASTRO STRADALE

- In polietilene bianco/rosso
- In scatola singola



Ref.		A			
60132	100 m	50 mm	1	3,75	2,15
60122	100 m	70 mm	1	4,80	2,75

PISTOLE PER SILICONE

- Cartucce 300 ml
- Ø 50 mm
- Corpo in alluminio
- Barra spinta zincata



REF. 68255



REF. 68250

Ref.					
68255	12			12,90	7,90
68250	12			4,45	2,90

TRACCIATORE CON CASSA IN ABS

- Tracciatore ricaricabile con 25 m di cordoncino e 150 g di polvere blu incluse.
- Cassa in ABS ergonomica, filo cotone diametro 2 mm.
- Fornito in blister.



Ref.	L				
60110	25 m	6		12,80	7,80

POLVERI PER TRACCIATURA

- Colore intenso
- Marcatura resistente ai raggi UV
- Buona aderenza
- Confezione da 400 g



Ref.		Gr.			
60113	●	400	1	7,80	4,80
60133	●	400	1	7,80	4,80

FLACONI DI POLVERE PER TRACCIATURE



Ref.		Gr.			
60127	●	1000	1	13,80	8,70
60128	●	1000	1	13,80	8,70
60141	●	3500	1	38,50	23,50
60140	●	3500	1	38,50	23,50

I PREZZI SI INTENDONO IVA ESCLUSA

TEMPERA MATITE



Ref.			
49159	10	4,00	2,60

MATITA 100% GRAFITE

- Matita al 100% grafite, **scrive su tutte le superfici**, dura 10 volte più di una matita tradizionale, punta sempre pronta, senza temperino, **non sporca le mani**, resistente agli urti e rotture.



**100%
GRAFITE**

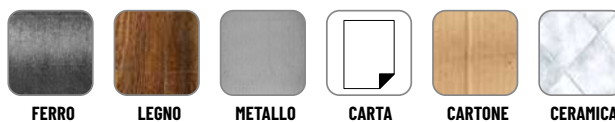

Ref.			
51150	1 pz	12	5,85 3,50
51151	blister 2 pz	1	13,40 7,50

Display da 36 pezzi in plexiglass

89206	box 36 pz	1	
--------------	-----------	---	--

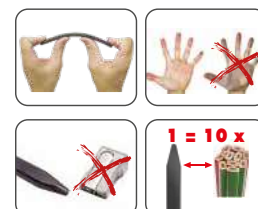

REF. 89206

MATITE PER FALEGNAMI

Confezione da 6 pz

Ref.				
51040	●	18 cm	20	2,50 1,80
51041	●	18 cm	20	2,50 1,80
51042	●	18 cm	20	2,50 1,80



Confezione da 3 pz

Ref.				
50390	●	30 cm	10	10,10 6,90

Confezione da 144 pz

Ref.				
51020	●	30 cm	1	233,50 160,00

MATITE PER MARMISTI

- Mina nera dura
- Forma piatta/ovale
per una migliore presa

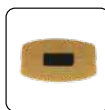

Confezione da 144 pz

Ref.				
51060	●	24 cm	1	165,00 110,00
51070	●	30 cm	1	248,50 142,50

Confezione da 3 pz

Ref.				
50393	●	24 cm	10	7,40 5,10

MATITA PER USO INDUSTRIALE

- Matita per l'industria e l'edilizia
- Fusto in bachelite nera
- Pomello in metallo
- **Mina nera gigante, diametro 5,5 mm**



MINE DI RICAMBIO
CONFEZIONE DA 6 PZ



Ref. 01090

Ref.			
51080	1	7,35	5,60
01090	1	5,90	3,60

I PREZZI SI INTENDONO IVA ESCLUSA

CALIBRO DIGITALE PROFESSIONALE

- Lettura numerica digitale con lancetta (ago) digitale su quadrante
- Acciaio inox **IP 67** qualità super professionale
- Luminosità dello schermo regolabile
- **Funzione assoluta (reset)** in ogni posizione e mantenimento del valore misurato (hold)
- **Batteria ricaricabile Li-ion incorporata**
- Cavo di ricarica in dotazione
- **Risoluzione 0,01 mm**
- **Precisione ± 0,02 mm**

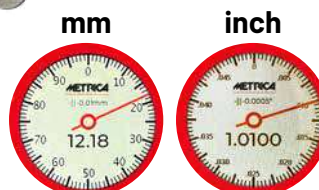
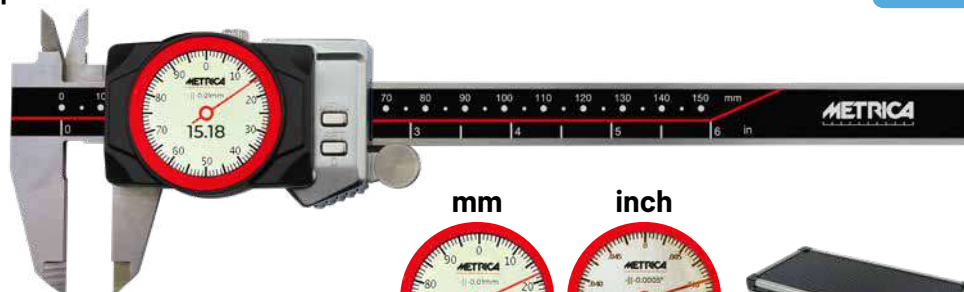
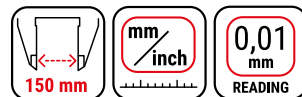

Ref.				
10029	0 - 150 mm	1	152,00	83,00

CALIBRO AD ALTA VISIBILITA'

- Modello professionale
- Acciaio inox temprato
- Schermo LCD ad alta visibilità, numeri giganti
- Funzione Absolute
- Impermeabile ai getti d'acqua e alla polvere
- **Risoluzione 0,01 mm**
- **Precisione ± 0,02 mm**
- **IP 54**



Ref.				
10084	0 - 150 mm	1	130,00	76,50

CALIBRO DIGITALE PROFESSIONALE

- Acciaio Inox
- **Nuova tecnologia del sensore (solo per Ref. 10026 - 10027)**
- Maggiore stabilità
- **Risoluzione 0,01 mm**
- **Precisione 0,02 mm**



Ref.				
10026	0 - 150 mm	1	80,80	47,80
10027	0 - 200 mm	1	100,00	64,90
10009	0 - 300 mm	1	141,00	84,80

NEW
NEW



I PREZZI SI INTENDONO IVA ESCLUSA

CALIBRO DIGITALE IP 65

- Acciaio inossidabile temprato
- **4 funzioni di misurazione**
- Impermeabile ai getti d'acqua e alla polvere
- **Precisione $\pm 0,02$ mm**
- **Risoluzione 0,01 mm**



Ref.

10001	0 - 150 mm	1	132,50	75,00
-------	------------	---	--------	-------



CALIBRO DIGITALE

NUMERI GIGANTI (11 MM)

- In acciaio inox temprato
- Display con numeri giganti
- **4 funzioni di misura**
- **Precisione $\pm 0,02$ mm**
- **Risoluzione 0,01 mm**



Ref.

10017	0 - 150 mm	1	56,80	27,00
-------	------------	---	-------	-------



CALIBRO DIGITALE DI PROFONDITÀ

- Acciaio inossidabile temprato
- **Precisione $\pm 0,02$ mm**
- Risoluzione 0,01 mm



Ref.

12145	0 - 200 mm	1	81,60	46,50
-------	------------	---	-------	-------



I PREZZI SI INTENDONO IVA ESCLUSA

CALIBRI SCOLASTICO

- Acciaio inossidabile temprato
- Scala graduata opaca
- **4 funzioni di misurazione**
- **Bloccaggio a leva**



Ref.				
10038	0 - 150 mm	1	22,60	13,00
10039	0 - 155 mm	1	25,20	14,00
10031	0 - 200 mm	1	34,60	20,80

REF. 10031
REF. 10038

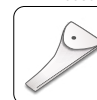

REF. 10039



CALIBRO MONOBLOCCO

- Acciaio inox temprato
- **Corsoio monoblocco**
- **Sistema di bloccaggio a leva**
- 4 funzioni di misura



Ref.				
10037	0 - 155 mm	1	45,00	25,00



CALIBRO DA OFFICINA

- Acciaio inossidabile temprato
- Scala graduata opaca
- **4 funzioni di misurazione**
- **Bloccaggio a vite**



Ref.				
10064	0 - 155 mm	1	22,70	13,00



I PREZZI SI INTENDONO IVA ESCLUSA

CALIBRI MONOBLOCCO

- Acciaio inossidabile temprato
- Scala graduata opaca
- **4 funzioni di misurazione**
- **Bloccaggio a vite**



Ref.				
10072	0 - 150 mm	1	54,20	35,20
10074	0 - 150 mm	1	57,80	31,50

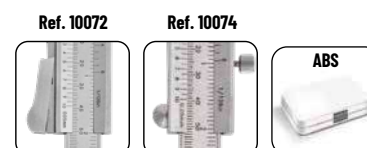

CALIBRO DI PRECISIONE

- Acciaio inossidabile temprato
- Scala graduata opaca
- **4 funzioni di misurazione**
- **Bloccaggio a vite**



Ref.				
11022	0 - 300 mm	1	155,50	99,00
12040	0 - 500 mm	1	284,00	187,70
12041	0 - 600 mm	1	300,50	199,50
12043	0 - 800 mm	1	698,00	466,80
12044	0 - 1000 mm	1	849,00	566,50



CALIBRO DI PROFONDITÀ

- Acciaio inossidabile temprato
- Scala graduata opaca
- **4 funzioni di misurazione**
- **Bloccaggio a vite**



Ref.				
10151	0 - 200 mm	1	70,00	32,40
10153	0 - 300 mm	1	93,40	42,80



I PREZZI SI INTENDONO IVA ESCLUSA

FALSA SQUADRA REGOLABILE

- Graduazione 240 mm
- Base in legno
- A 150 - B 250 mm

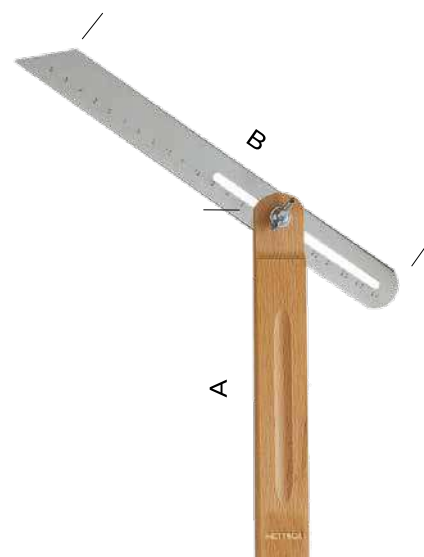

Ref.



69650

5

12,60

8,50

SQUADRA A CAPPELLO IN ACCIAIO ZINCATO

- Squadra in acciaio normale non temprato con zincatura di protezione.

Ref.	L			
29192	100 x 70 mm	3	10,10	6,80
29193	150 x 100 mm	3	12,70	8,50
29194	200 x 130 mm	3	16,40	11,20
29195	250 x 165 mm	3	20,60	13,90
29196	300 x 200 mm	3	23,30	15,50
29197	400 x 250 mm	3	30,50	19,80
29198	500 x 330 mm	1	37,30	24,50
29199	600 x 400 mm	1	42,10	27,00
29200	800 x 400 mm	1	55,60	35,60
29210	1000 x 500 mm	1	67,00	42,80



SQUADRA SEMPLICE IN ACCIAIO ZINCATO

- Squadra in acciaio normale non temprato con zincatura di protezione.

Ref.	L			
29182	100 x 70 mm	3	8,10	5,50
29183	150 x 100 mm	3	10,90	6,70
29184	200 x 130 mm	3	12,50	7,90
29185	250 x 165 mm	3	14,60	9,20
29186	300 x 200 mm	3	16,50	11,00
29187	400 x 250 mm	3	20,50	13,50
29188	500 x 330 mm	1	23,00	15,50
29189	600 x 400 mm	1	27,80	18,60
29190	800 x 400 mm	1	34,10	23,00
29191	1000 x 500 mm	1	40,50	27,00



I PREZZI SI INTENDONO IVA ESCLUSA

SQUADRA PER CARPENTIERE

- Acciaio verniciato

Ref.				
29354	L 400 mm	5	11,50	6,50
29355	L 500 mm	5	12,40	7,20
29356	L 600 mm	5	13,90	8,20
29357	L 700 mm	5	15,10	9,30
29358	L 800 mm	5	18,70	10,60
29359	L 1000 mm	5	20,90	11,80

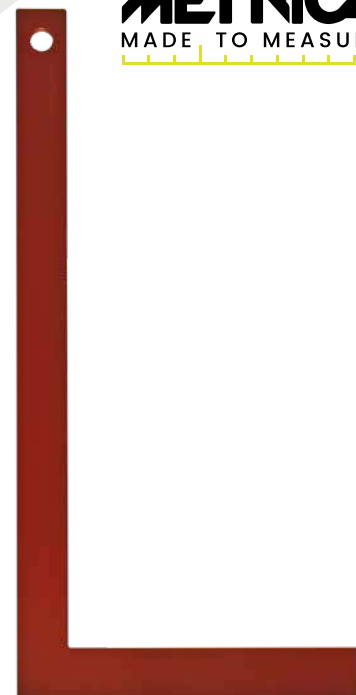

SQUADRA PROFESSIONALE PER FALEGNAME

Ref.				
29252	L 200 mm	5	15,40	11,50
29253	L 250 mm	5	16,70	12,40
29254	L 300 mm	5	17,20	12,90
29255	L 350 mm	5	20,10	15,00
29256	L 400 mm	5	21,90	16,20
29257	L 500 mm	5	26,70	19,80

- Lama in acciaio temprato graduata
- Base in alluminio estruso anodizzato nero

Ref.				
29232	L 200 mm	5	15,40	11,50
29233	L 250 mm	5	16,70	12,40
29234	L 300 mm	5	17,20	12,90
29235	L 350 mm	5	20,10	15,00
29236	L 400 mm	5	21,90	16,20
29237	L 500 mm	5	26,70	19,80

serie 29252
BIANCA



serie 29232
GIALLA



SQUADRA PER FALEGNAME

- Lama in acciaio temprato
- Base in alluminio fuso

Ref.				
29240	L 150 mm	5	4,05	2,90
29241	L 200 mm	5	4,50	3,10
29242	L 250 mm	5	4,75	3,40
29243	L 300 mm	5	5,35	3,80
29244	L 350 mm	5	6,15	4,30
29245	L 400 mm	5	6,80	4,80
29247	L 500 mm	5	9,05	6,50



I PREZZI SI INTENDONO IVA ESCLUSA

PROFILOMETRO ANTIGRAFFIO

- Per rilievo sagome o profili, aghi mobili, in plastica antigraffio,
- Fornito in blister.



Ref.			
72005	1	52,20	32,00

PROFILOMETRO ACCIAIO

- Per rilievo sagome o profili, aghi mobili, in plastica antigraffio,
- Fornito in blister.



Ref.			
72002	1	113,00	79,00

SUPPORTI MAGNETICI

- Multifunzione: per saldare, montare, fissare
- Magnetico su tutti i lati



Ref. 60305

Ref. 60304

Ref. 60300

Ref.	A x A mm			
60300	85 x 85	1	7,60	4,90
60304	110 x 110	1	8,75	6,50
60305	135 x 135	1	12,10	9,50

VENTOSE

- Ventose per vetrai con impugnatura gommata antiscivolo.
- **Diametro 120 cm**



Ref. 50541

Ref. 50543

Ref. 50545

Ref.				
50541	25 kg	5	11,50	6,60
50543	50 kg	5	22,80	13,90
50545	75 kg	2	24,80	15,50

I PREZZI SI INTENDONO IVA ESCLUSA

COMPARATORE DI PRECISIONE

- Quadrante girevole con bottone di bloccaggio, indici di tolleranza,
- Custodia in ABS



Ref.	A mm			
41019	0-10	1	30,80	17,00

MISURATORE DI SPESSORE DECIMALE TASCABILE

- Lettura 0,1 mm, con bottone di bloccaggio, forma ergonomica,
- **Supporto in alluminio e vernice antiscivolo**
- Astuccio in similpelle

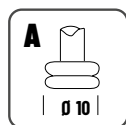

Ref.	C mm	P mm				
43051	0-10	20	A	1	110,50	72,00
43052	0-20	20	A	1	115,50	75,80
43053	0-20	50	A	1	123,00	80,00

COMPARATORE DI PRECISIONE

- Quadrante regolabile con frecce di tolleranza
- Precisione secondo
- **DIN 878**
- Custodia in ABS



Ref.	A mm			
41010	0-5	1	59,80	34,00

MISURATORE DI SPESSORE A QUADRANTE DECIMALE

- Lettura 0,1 mm, impugnatura ergonomica
- **Supporto in alluminio e vernice antigraffio, leva di sollevamento**

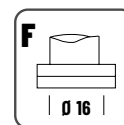

Ref.	C mm	P mm				
43055	0-30	200	F	1	227,00	135,00
43056	0-30	300	F	1	233,50	143,00
43057	0,30	450	F	1	509,00	300,00

I PREZZI SI INTENDONO IVA ESCLUSA

MICROMETRO DA OFFICINA

- Micrometro per officina, contatti in metallo duro, arco verniciato,
- Leva di bloccaggio
- Custodia in ABS



Ref.	A mm			
44130	0-25	1	27,20	15,50

SPESSIMETRO

- Spessimetro con custodia
- In metallo



Ref.	S mm	L mm	N			
35102	0,05 ÷ 1	100	20	5	7,00	4,90
35103	0,05 ÷ 2	100	20	1	19,30	12,00
35104	0,10 ÷ 0,30	75	5	4	4,05	2,90
35105	0,03 ÷ 0,10	100	8	4	6,20	3,20

NASTRI GRADUATI PIANI

- Nastro graduato in acciaio smaltato **bianco** o **giallo**
- Sezione 13 x 0,2 mm
- Decimali rossi
- Con biadesivo (senza biadesivo a richiesta)
- Larghezza 16 mm a richiesta
- **Lunghezza e graduazioni a richiesta**

Ref.	L mm				
39821	2000	0->	1	24,40	17,50
39822	3000	0->	1	35,00	25,20
39823	5000	0->	1	62,00	44,50
39826	2000	<-0	1	26,30	18,90
39827	3000	<-0	1	38,10	27,50
39828	5000	<-0	1	66,60	47,90

Acciaio smaltato **bianco**

RIGHE INOX NEW GRADUATION

- Graduazione con linee di lunghezza variabile per una facile lettura - design registrato
- Facile presa all'estremità piegata (tranne il righello da 1 metro)
- **Punti alternati ogni 2 mm**
- Acciaio inossidabile opaco
- Graduazione incisa in nero.
- Lati rettificati

SISTEMA DI PRESA



Ref.					
24300	150 mm	15 x 0,5 mm	1	3,95	2,90
24301	200 mm	15 x 0,5 mm	1	4,40	3,20
24303	300 mm	15 x 0,5 mm	1	5,20	3,70
24320	300 mm	30 x 1 mm	1	15,50	11,00
24321	500 mm	30 x 1 mm	1	22,10	15,80
24322	1000 mm	30 x 1 mm	1	61,00	38,50



Ref.	L mm				
39831	2000	0->	1	24,40	17,50
39832	3000	0->	1	35,00	25,00
39833	5000	0->	1	60,00	43,00
39836	2000	<-0	1	26,30	18,90
39837	3000	<-0	1	38,10	27,50
39838	5000	<-0	1	68,60	49,00

Acciaio smaltato **giallo**

I PREZZI SI INTENDONO IVA ESCLUSA

PUNZONI PROFESSIONALI

- Serie alfabeto, 27 lettere acciaio temperato
- Qualità extra: Cr-V (6150)

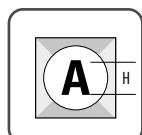

Ref.	H		ACCAIO TEMPERATO	
70133	3	1	33,10	18,80
70134	4	1	38,30	19,00
70135	5	1	47,40	27,00
70136	6	1	58,80	34,00
70137	8	1	88,40	52,00

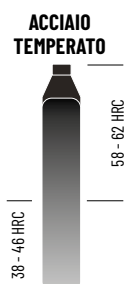

PUNZONI PROFESSIONALI

- Serie numerica, 9 cifre acciaio temperato
- Qualità extra: Cr-V (6150)

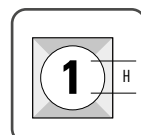

Ref.	H		ACCAIO TEMPERATO	
70143	3	1	12,80	7,40
70144	4	1	13,20	7,60
70145	5	1	16,70	9,50
70146	6	1	20,00	11,60
70147	8	1	27,50	15,20

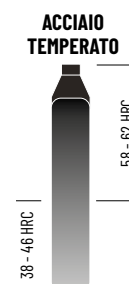

COMPASSO A SETTORE

- Compasso semplice, punte diritte in acciaio temperato, sezione quadrata, snodo di articolazione con rivetto, esecuzione robusta.



Ref.			ACCAIO TEMPERATO	
48053	150 mm	2	19,80	12,30
48055	200 mm	2	24,70	14,90
48056	250 mm	2	30,30	18,90
48057	300 mm	2	36,80	22,50

COMPASSO SEMPLICE

- Compasso semplice, punte diritte in acciaio temperato, sezione quadrata, snodo di articolazione con rivetto, esecuzione robusta.



Ref.			ACCAIO TEMPERATO	
48002	150 mm	2	15,90	9,10
48003	200 mm	2	17,50	10,60
48004	250 mm	2	24,40	14,00
48005	300 mm	2	28,60	16,50

I PREZZI SI INTENDONO IVA ESCLUSA

METRICA

Metrica S.p.A.

Via Grandi, 18 - 20097 San Donato Milanese (MI) - Italia

METRICA.IT



DISPLAY LINEARE 1M
Ref. 98003
250 x 100 x 55 cm



DISPLAY LASERS
Ref. Expo AutoL
200 x 45 x 30 cm



DISPLAY VETRINA
Ref. VETR.BIA
178 x 38 x 38 cm



DISPLAY TOWER
Ref. TOWER
160 x 32 cm



EXPO FLASH
30 x 45 x 16 cm



EXPO FLESS
21 x 51 cm



EXPO 61435
15 x 41 cm



EXPO TELEFIX
65 x 150 x 30 cm



EXPO LIVELLE
40 x 24 cm



EXPO CUBO
22 x 22 x 22 cm



EXPO61115
18 x 27 x 11 cm



EXPO61111
18 x 27 x 11 cm

Valido fino al 30.06.2026, salvo errori di prezzo, stampa e tecnici

Nel corso di validità del presente catalogo, i prodotti potrebbero subire modifiche, rispetto alle immagini proposte, che non ne compromettono l'utilizzo o le caratteristiche tecniche. Metrica si riserva la facoltà di apportare modifiche senza obbligo di preavviso.