

CIEFFEPLAST s.r.l.

La nostra idea **fissa!**



COBRA[®]
CABLE TIES
MADE IN ITALY

Cieffeplast Profile

Un'azienda con valori. A Company with Values.

Cieffeplast produce e vende da anni articoli tecnici in plastica specializzandosi in prodotti per il fissaggio in nylon PA6.6, principalmente fascette di cablaggio, accessori per il fissaggio e tasselli.

Cieffeplast has been producing and selling technical plastic items for years, specializing in PA6.6 nylon fastening products, mainly cable ties, fastening accessories and plugs.



30 ANNI DI ESPERIENZA
AL VOSTRO SERVIZIO

30 YEARS OF EXPERIENCE
AT YOUR SERVICE



PRODUZIONE 100%
MADE IN ITALY

100% MADE IN ITALY
PRODUCTION



QUALITÀ DEI PRODOTTI
GARANTITA

GUARANTEED QUALITY
OF THE PRODUCTS



ALTA DISPONIBILITÀ
IN STOCK A MAGAZZINO

HIGH STOCK AVAILABILITY



GUIDA E SUPPORTO
ALL'APPROVVIGIONAMENTO

GUIDE AND SUPPORT
TO THE SUPPLY

Index

- 04** **La nostra idea Fissa!** Chi siamo
Our Fixed idea! About us
- 08** **Fascette**
Cable ties
- 10** Utilizzo del prodotto
Using instructions
- 12** Fascette standard
Standard cable ties
- 20** Fascette standard colorate
Standard coloured cable ties
- 24** Fascette stabilizzate UV
UV stabilized cable ties
- 26** Fascette termoresistenti
Heat stabilized cable ties
- 28** Fascette riapribili
Releasable cable ties
- 30** Fascette d'installazione PA66
Installation cable ties PA66
- 32** Fascette d'installazione PA12
Installation cable ties PA12
- 34** Fascette d'identificazione
Cable ties with marker plate
- 40** Fascette con occhiello
Mounting cable ties
- 42** Fascette ad innesto rapido
Push mount cable ties
- 46** Utensili per il fissaggio
Fixing tools
- 50** Sigilli inviolabili
Plastic seals
- 58** Espositore da banco SMART
Counter display SMART
- 62** Espositore da pavimento su ruote
Floor display with wheels
- 63** Espositore girevole da banco
Convenient revolving counter display
- 64** **Accessori**
Accessories
- 66** Basette bidirezionali con adesivo
Self adhesive tie mount
- 68** Tassello per fascette
Wall plug for cable ties
- 70** Supporto a sella con fissaggio a vite
Saddle mount with fixing screw
- 72** Supporto adesivo per cavo tondo
Self adhesive cable clamps
- 74** Spirale in polietilene
Polyethylene spiral cable wrap
- 76** **Tasselli**
Wall plugs
- 78** Caratteristiche tecniche
Technical features
- 80** Tasselli tenax TX senza collarino
Wall plugs tenax TX without collar
- 81** Tasselli tenax TX con collarino
Wall plugs tenax TX with collar
- 82** Utilizzo del prodotto
Using instructions
- 83** Tasselli a battuta
Hammer wall plugs
- 88** **Contatti**
Contacts

ABOUT US

La nostra idea **Fissa!** Our **Fixed** idea!

Cieffeplast produce da anni articoli tecnici in plastica specializzandosi in prodotti per il fissaggio.

Azienda italiana che produce e vende fascette per cablaggio, accessori per il fissaggio e tasselli. Da anni si rivolge al mercato italiano ed internazionale offrendo qualità e velocità nelle forniture.

Ci occupiamo di produrre e commercializzare articoli tecnici per il fissaggio in plastica, principalmente fascette di cablaggio e tasselli. Siamo rivolti al mercato nazionale ed internazionale, offrendo servizi personalizzati e flessibilità.

Cieffeplast has produced technical plastic articles for years, specializing in products for fastening.

Italian company, manufacturer and seller of cable ties, fixing accessories and wall plugs. For many years it has been addressing the italian and international market, offering quality supplies and fast deliveries.

We produce and sell technical items in plastic, especially cable ties and wall plugs. We address the national and international market, offering flexibility and customized services.



LINEA DEL TEMPO TIMELINE

In attività dal 1986, nel 2000 realizza l'attuale produzione di articoli di fissaggio in plastica grazie all'ampia esperienza dei fondatori. Azienda snella e flessibile si caratterizza per l'importante investimento tecnologico che persegue da anni; una costante che oggi garantisce alta produttività in pieno controllo automatico. Il background tecnologico acquisito negli anni rende internazionale la linea di prodotti per il fissaggio "Cobra" che include fascette di cablaggio e tasselli.

Presente in numerosi mercati, garantisce alta disponibilità di magazzino e servizi personalizzati.

In business since 1986, thanks to the wide experience of the founders in 2000 the company realizes the current production of plastic articles for fastening. Simple and flexible, the company is characterized by its major technology investment pursued for years; a constant that today ensures high productivity in fully automatic control. The technological background acquired over the years has made internationally known the "Cobra" line of products for fastening that includes cable ties and wall plugs.

Present in numerous markets, Ciefplast ensures high availability of stock and custom services.

2025

2022

2021

2017

2014

2006

2001

2000

1995

1986

Nuovo sito
Restyling website

Spedizioni più rapide
Faster shipping

Industria 4.0
Industry 4.0

Esportate in 60 Paesi
Export to 60 countries

Ciefplast nel mondo
Ciefplast in the world

Nuova sede di 4000m²
New 4000m² headquarter

Nascita della linea Cobra
Birth of the Cobra line

Nasce Ciefplast
Ciefplast is born

Avviamento attività
Business start-up

Linea di prodotti a marchio Cobra *Line of products branded Cobra*

La garanzia di Cieffeplast nel controllo di tutte le fasi di lavorazione, dalla scelta delle materie prime fino al confezionamento è rappresentato dal brand Cobra. Nel 2000 abbiamo nominato il nostro brand scegliendo la parola Cobra. Le motivazioni di questa scelta sono sicuramente legate al re dei rettili. Uno dei serpenti più forti al mondo, e a detta degli erpetologi la specie più intelligente tra tutti i serpenti, accomuna alcune sue particolarità con la gamma di fascette e tasselli che porta il suo nome. La posizione del rettile in fase di attacco, la testa forte e grande, i denti aguzzi e resistenti ed un'elastica apertura mandibolare sono caratteristiche rivisitate ed adattate nei prodotti che produciamo.

The guarantee of Cieffeplast in the control of all the processing steps, from the selection of raw materials to the packaging, is represented by the brand Cobra. In 2000, we named our brand by choosing the word Cobra. The reasons behind this choice are definitely related to the king of reptiles. One of the most powerful snakes in the world, and according to herpetologists the most intelligent species among all snakes, combines some of its particularities with the range of cable ties and wall plugs that bears its name. The reptile attacking position, its strong and large head, strong sharp teeth and elastic mandibular opening are features revisited and adapted in the products we produce. Also phonology helped us since it makes the mark readable in the same way in many countries. Even though the Cobra is a very rare reptile in our country, we have not forgotten to keep the red and white colors that connect us to the area where the range of cable ties and wall plugs are designed and produced.

COBRA[®]
CABLE TIES
MADE IN ITALY

Brand Identity aziendale

Company Brand Identity

Il logo grafico che presenta al mondo l'azienda padovana produttrice di articoli di fissaggio in plastica, fondata nel 1986, è il segno distintivo che veicola la nostra identità aziendale; è il carattere dell'Impresa. Il nome dell'azienda nasce da un richiamo alle iniziali dei fondatori "C" ed "F", allungati in CIEFFE e si conclude con il materiale che lavoriamo da anni e cioè la plastica "PLAST". Gli impianti produttivi e lo stabilimento hanno sede in provincia di Padova ecco perché il logo è sviluppato nei colori bianco e rosso caratteristici della bandiera della provincia legandoci ancor di più al nostro territorio. All'interno della C troviamo il caratteristico punto rosso che ci piace immaginare sia il "Cuore" battente di Cieffeplast.

The graphic logo that presents to the world the Paduan manufacturer of fastening articles in plastic, founded in 1986, is the hallmark that conveys our corporate identity; it is the Company's character. The company's name comes from a reference to the founders' initials, "C" and "F", stretched to CIEFFE, and ends with "Plast", plastic, the material we have been working for years. The factory and the manufacturing facilities are located in the province of Padua, and this is why the logo has been developed in white and red, the characteristic colors of the flag of the province, thus connecting us even more to our territory. Inside the C we find the distinctive red point that we like to imagine is the beating "Heart" of Cieffeplast.

CIEFFEPLAST s.r.l.

Fascette naturali e nere
Natural and black cable ties

Fascette colorate
Coloured cable ties

Fascette stabilizzate UV
UV stabilized cable ties

Fascette termoresistenti
Heat stabilized cable ties

Fascette riapribili
Releasable cable ties

Fascette d'installazione
Installation cable ties

Fascette d'identificazione
Cable ties with marker plate

Fascette con occhiello
Mounting cable ties

Fascette ad innesto
Push mount cable ties

Fascette a sigillo
Plastic seals



FASCETTE *CABLE TIES*

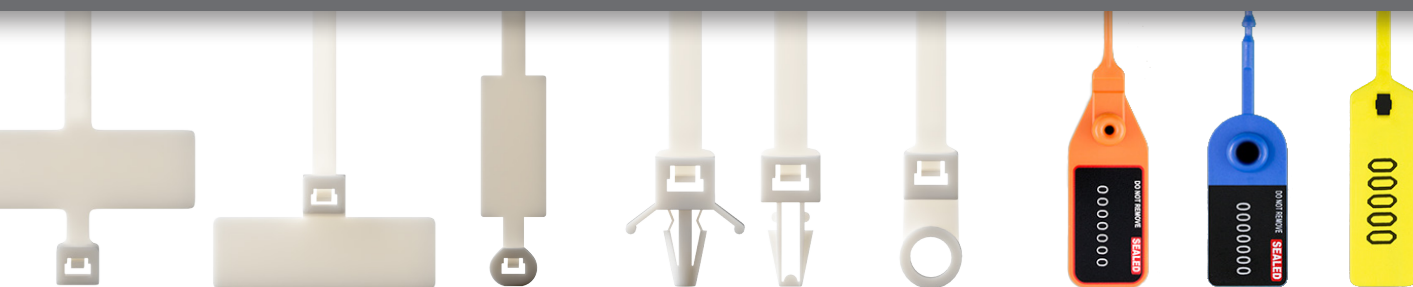

TECHNICAL FEATURES

Utilizzo del prodotto Using instructions

APPLICAZIONI: Servono per la legatura, per fissare e sigillare, una volta chiuse non sono riapribili. Trovano applicazione in modo particolare nei cablaggi elettrici dov'è necessario tenere uniti o fissare dei cavi, sono inoltre utili in tutte le situazioni dove serve un legaccio non riapribile.

MODALITÀ DI UTILIZZO: Avvolgere con la fascetta i prodotti da fissare, inserire il codino nella propria testa fino al dentino di preaggancio, posizionare correttamente gli elementi da fissare, (se necessario con una leggera trazione la fascetta si può ancora riaprire per un miglior posizionamento) prendere il codino nella parte zigrinata ed esercitare una trazione fino al completo serraggio. Tagliare la parte sporgente non utilizzata.

AVVERTENZE: Per usi esterni utilizzare colore nero che è maggiormente protetto ai raggi UV. Da non usare su parti del corpo.

TENUTA AGLI AGENTI ESTERNI

Resiste alle basi olii, grassi, saponi, detersivi, prodotti petroliferi, solventi cloranti, alcoli. Tenuta limitata agli acidi. ** Non resiste al fenolo.

** Per resistenza agli acidi sono disponibili alcune misure di fascette in polipropilene.

APPLICATIONS: They are made for the fastening, to fix and to seal, once sluces they can't be re-opened. They are particularly suitable for electrical wirings where is necessary to hold united or to fix the cables, moreover are useful in all the situations where they must be used as a not re-opening string.

HOW TO USE THEM: With the ties wrap the products to fix, insert the small queue into its own head to the pre-coupling tooth, set correctly the elements to fix, (if necessary with a light traction the tie can be still re-opened for a better positioning) take the queue in the knurled part and pull until it's completely closed. Cut the outsider part not used.

WARNINGS: Use black color for external uses, 'cause it's strongly protected by uv beams. Don't use on body parts.

HELD THE EXTERNAL AGENTS

It resists to bases oils, greases, soaps, detergents, petroliferous products, clorura dissolvents, alcoli. Limited held to acids. ** It does not resist to phenol.

** Some sizes of polypropylene cable ties are available for resistance to acids.



TEMPERATURA UTILIZZO - TEMPERATURE OF USE:

di esercizio - of exercise	-40°C + 85°C
di montaggio - of assembly	-10°C + 60°C
punta massima assimilabile per brevi periodi maximum tip assimilable for short periods	+ 110°C
di fusione - of fusion	+256°C
tenuta alla fiamma - held to the flame *	conforme UL 94 classe V2 - true to law UL 94 class V2
assorbimento umidità - absorption humidity	2,7% (in esposizione all'aria con 50% di U.R. in exposure to the air with 50% of U.R.)

* Per tutte le fascette in poliammide 6.6 vengono utilizzati materiali classificati UL94V2

* Classified material UL94V2 are used for all polyamide 6.6 cable ties

Perché scegliere le fascette Cobra? Why choose Cobra cable ties?

I nostri articoli sono costantemente monitorati e anche un piccolo suggerimento può dar vita ad un grande affinamento del prodotto. Ecco perché negli anni gli articoli Cobra non sono rimasti uguali ma si sono migliorati. Migliorati nel loro funzionamento, per incontrare il più possibile le necessità di chi li usa giornalmente.

Our items are constantly monitored and even a small suggestion can lead to a great product betterment. This is why over the years our Cobra articles have not remained the same but have improved. Improved in their functioning, to meet the needs of those who use them daily as much as possible.



Testina arrotondata per evitare spigoli nei cablaggi o e angoli interni raggati per aumentare la tenuta.

Rounde cable ties' head to avoid edge in the wiring and radiated inner corners to increase the tensile strenght.

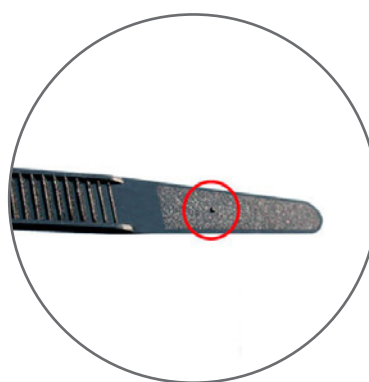

Il dentino di preaggancio permette di preparare la fascetta per la chiusura, evitando che si sfilii. La superficie ruvida facilita la presa.

The small pre-coupling tooth allows to prepare the ties to be closed, avoiding to get it unstrung. Rough surface to easy handling.

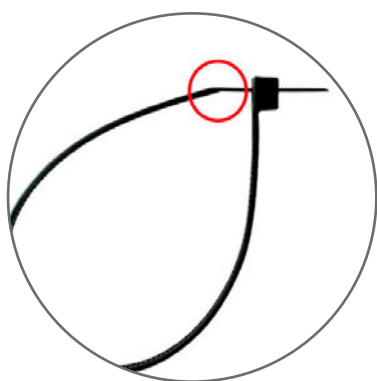

Le misure corte hanno il collarino inclinato per facilitare l'inserimento.

Short sizes have the small collar slanted in order to ease the fitting.

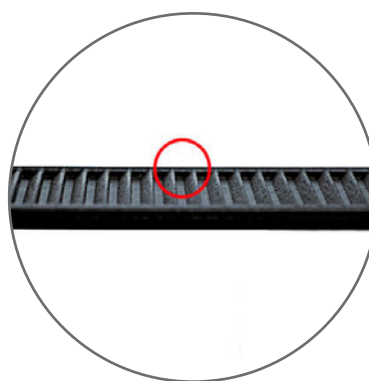

I bordi laterali sono alti come la cremagliera per evitare di incidere i cavi.

The lateral edge are high as the rack to avoid cutting the cables.

FASCETTE - CABLE TIES

Fascette standard

FASCETTE IN PA66 COLORE NATURALE O NERO

Standard cable ties

CABLE TIES IN PA66 NATURAL OR BLACK

Fascette di cablaggio prodotte in PA6.6, colore naturale e nero, sono suggerite in naturale per applicazioni in ambienti interni ed in nero per applicazioni in ambiente esterno. Attraverso il sistema d'aggancio tra dente e cremagliera permettono il fissaggio di vari diametri. Facilmente installabili manualmente. In caso di applicazione con l'utilizzo di utensile si raccomanda la corretta regolazione di tensione dello stesso proporzionata alla dimensione della fascetta. Sono disponibili utensili per l'installazione a pagina 46.

Le fascette per cablaggio Cobra® sono state testate secondo la norma di riferimento UL 62275 con certificato numero E468944.

Wiring cable ties made of PA6.6, in natural and black colors, are suggested in natural color for indoor applications, and in black color for outdoor applications. The hooking system between the pawl and the rack permits the fixing of various diameters. Easy manual installation. In case of a non-manual installation, please make sure your tool is regulated for a stress in proportion to the size of the cable tie. Cable ties tools are available at page 46.

Cobra® cable ties have been tested in accordance to UL 62275 with certification number E468944.

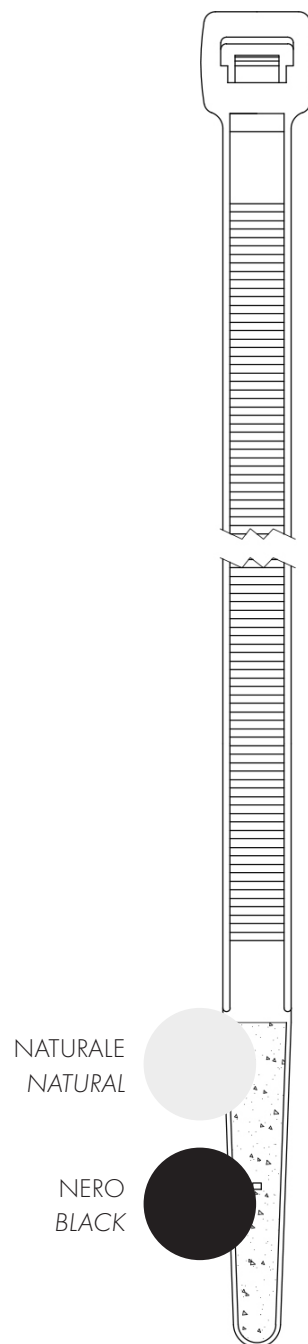

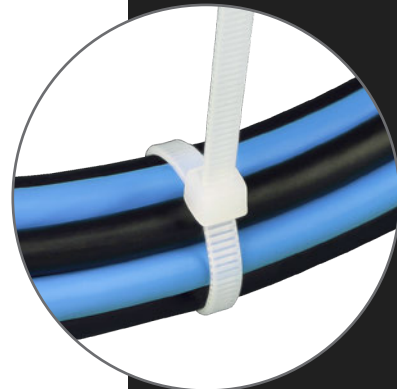
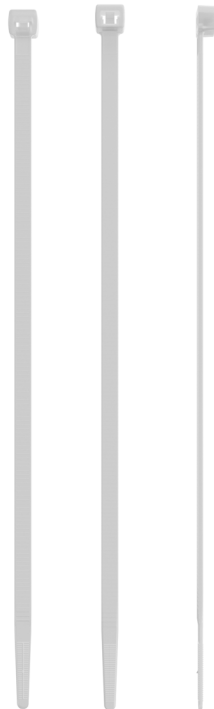
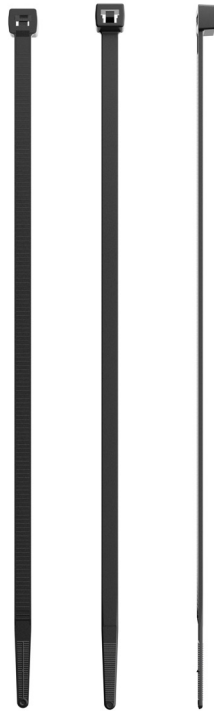



Fascette in PA66 colore naturale Cable ties in PA66 natural

Imballo standard
Standard packaging





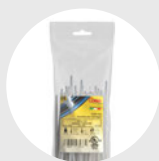

Fascetta in PA66
colore naturale
Cable ties in PA66
natural



CONFEZIONI da
Pz. 100
BAG of 100 pcs



Imballo standard
Standard packaging

COD. ART. ITEM CODE	DESCRIZIONE DESCRIPTION	MISURA SIZE (mm)	COLORE COLOUR	 PZ. PCS.	 PZ. IMBALLO CARTON PCS.	 MAX (mm)	 MIN (Kg)
9030	Fascetta in poliammide 66 - Cable ties in polyamide 66	80x2,4	naturale - natural	100	30.000	17	8.0
9050	Fascetta in poliammide 66 - Cable ties in polyamide 66	100x2,5	naturale - natural	100	30.000	22	8.1
9070	Fascetta in poliammide 66 - Cable ties in polyamide 66	140x2,5	naturale - natural	100	25.000	34	8.1
9090	Fascetta in poliammide 66 - Cable ties in polyamide 66	160x2,5	naturale - natural	100	20.000	40	8.1
9080	Fascetta in poliammide 66 - Cable ties in polyamide 66	200x2,5	naturale - natural	100	20.000	53	8.1
9130	Fascetta in poliammide 66 - Cable ties in polyamide 66	140x3,6	naturale - natural	100	20.000	33	18.2
9150	Fascetta in poliammide 66 - Cable ties in polyamide 66	200x3,6	naturale - natural	100	12.000	51	18.2
9180	Fascetta in poliammide 66 - Cable ties in polyamide 66	250x3,6	naturale - natural	100	12.000	67	18.2
9160	Fascetta in poliammide 66 - Cable ties in polyamide 66	290x3,6	naturale - natural	100	12.000	80	18.2
9170	Fascetta in poliammide 66 - Cable ties in polyamide 66	360x3,6	naturale - natural	100	9.000	102	18.2
9210	Fascetta in poliammide 66 - Cable ties in polyamide 66	200x4,5	naturale - natural	100	12.000	50	22.2
9240	Fascetta in poliammide 66 - Cable ties in polyamide 66	160x4,8	naturale - natural	100	10.000	38	22.2
9250	Fascetta in poliammide 66 - Cable ties in polyamide 66	175x4,8	naturale - natural	100	10.000	42	22.2
9260	Fascetta in poliammide 66 - Cable ties in polyamide 66	200x4,8	naturale - natural	100	10.000	50	22.2
9270	Fascetta in poliammide 66 - Cable ties in polyamide 66	250x4,8	naturale - natural	100	10.000	66	22.2
9280	Fascetta in poliammide 66 - Cable ties in polyamide 66	290x4,8	naturale - natural	100	10.000	78	22.2
9290	Fascetta in poliammide 66 - Cable ties in polyamide 66	360x4,8	naturale - natural	100	7.500	100	22.2
9300	Fascetta in poliammide 66 - Cable ties in polyamide 66	430x4,8	naturale - natural	100	5.000	123	25.8
9320	Fascetta in poliammide 66 - Cable ties in polyamide 66	530x4,8	naturale - natural	100	3.000	155	25.8
9410	Fascetta in poliammide 66 - Cable ties in polyamide 66	200x7,6	naturale - natural	100	5.000	49	54.4
9420	Fascetta in poliammide 66 - Cable ties in polyamide 66	250x7,6	naturale - natural	100	5.000	64	54.4
9430	Fascetta in poliammide 66 - Cable ties in polyamide 66	290x7,6	naturale - natural	100	5.000	77	54.4
9440	Fascetta in poliammide 66 - Cable ties in polyamide 66	360x7,6	naturale - natural	100	4.000	98	54.4
9450	Fascetta in poliammide 66 - Cable ties in polyamide 66	450x7,6	naturale - natural	100	3.000	127	54.4
9460	Fascetta in poliammide 66 - Cable ties in polyamide 66	530x7,6	naturale - natural	100	2.500	152	54.4
9470	Fascetta in poliammide 66 - Cable ties in polyamide 66	750x7,6	naturale - natural	100	2.000	218	54.4
9510	Fascetta in poliammide 66 - Cable ties in polyamide 66	530x9,0	naturale - natural	100	2.000	150	79.8
9520	Fascetta in poliammide 66 - Cable ties in polyamide 66	780x9,0	naturale - natural	100	1.500	228	79.8
9540	Fascetta in poliammide 66 - Cable ties in polyamide 66	1500x9,0	naturale - natural	100	500	460	79.8
9590	Fascetta in poliammide 66 - Cable ties in polyamide 66	1000x12,6	naturale - natural	100	600	295	114.0



Fascette in PA66 colore naturale Cable ties in PA66 natural

Imballo small
Small packaging





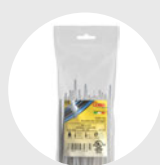

Fascetta in PA66
colore naturale
Cable ties in PA66
natural



CONFEZIONI da
Pz. 100
BAG of 100 pcs



Imballo small
Small packaging

COD. ART. ITEM CODE	DESCRIZIONE DESCRIPTION	MISURA SIZE (mm)	COLORE COLOUR	 PZ. PCS.	 PZ. IMBALLO CARTON PCS.	 MAX (mm)	 MIN (Kg)
9030C	Fascetta in poliammide 66 - Cable ties in polyamide 66	80x2,4	naturale - natural	100	5.000	17	8.0
9050C	Fascetta in poliammide 66 - Cable ties in polyamide 66	100x2,5	naturale - natural	100	5.000	22	8.1
9070C	Fascetta in poliammide 66 - Cable ties in polyamide 66	140x2,5	naturale - natural	100	5.000	34	8.1
9090C	Fascetta in poliammide 66 - Cable ties in polyamide 66	160x2,5	naturale - natural	100	5.000	40	8.1
9080C	Fascetta in poliammide 66 - Cable ties in polyamide 66	200x2,5	naturale - natural	100	5.000	53	8.1
9130C	Fascetta in poliammide 66 - Cable ties in polyamide 66	140x3,6	naturale - natural	100	5.000	33	18.2
9150C	Fascetta in poliammide 66 - Cable ties in polyamide 66	200x3,6	naturale - natural	100	5.000	51	18.2
9180C	Fascetta in poliammide 66 - Cable ties in polyamide 66	250x3,6	naturale - natural	100	5.000	67	18.2
9160C	Fascetta in poliammide 66 - Cable ties in polyamide 66	290x3,6	naturale - natural	100	5.000	80	18.2
9170C	Fascetta in poliammide 66 - Cable ties in polyamide 66	360x3,6	naturale - natural	100	4.000	102	18.2
9210C	Fascetta in poliammide 66 - Cable ties in polyamide 66	200x4,5	naturale - natural	100	5.000	50	22.2
9240C	Fascetta in poliammide 66 - Cable ties in polyamide 66	160x4,8	naturale - natural	100	5.000	38	22.2
9250C	Fascetta in poliammide 66 - Cable ties in polyamide 66	175x4,8	naturale - natural	100	5.000	42	22.2
9260C	Fascetta in poliammide 66 - Cable ties in polyamide 66	200x4,8	naturale - natural	100	5.000	50	22.2
9270C	Fascetta in poliammide 66 - Cable ties in polyamide 66	250x4,8	naturale - natural	100	5.000	66	22.2
9280C	Fascetta in poliammide 66 - Cable ties in polyamide 66	290x4,8	naturale - natural	100	5.000	78	22.2
9290C	Fascetta in poliammide 66 - Cable ties in polyamide 66	360x4,8	naturale - natural	100	4.000	100	22.2
9300C	Fascetta in poliammide 66 - Cable ties in polyamide 66	430x4,8	naturale - natural	100	3.000	123	25.8
9320C	Fascetta in poliammide 66 - Cable ties in polyamide 66	530x4,8	naturale - natural	100	1.000	155	25.8
9410C	Fascetta in poliammide 66 - Cable ties in polyamide 66	200x7,6	naturale - natural	100	2.000	49	54.4
9420C	Fascetta in poliammide 66 - Cable ties in polyamide 66	250x7,6	naturale - natural	100	2.000	64	54.4
9430C	Fascetta in poliammide 66 - Cable ties in polyamide 66	290x7,6	naturale - natural	100	2.000	77	54.4
9440C	Fascetta in poliammide 66 - Cable ties in polyamide 66	360x7,6	naturale - natural	100	2.000	98	54.4
9450C	Fascetta in poliammide 66 - Cable ties in polyamide 66	450x7,6	naturale - natural	100	1.500	127	54.4
9460C	Fascetta in poliammide 66 - Cable ties in polyamide 66	530x7,6	naturale - natural	100	1.000	152	54.4
9470C	Fascetta in poliammide 66 - Cable ties in polyamide 66	750x7,6	naturale - natural	100	500	218	54.4
9510C	Fascetta in poliammide 66 - Cable ties in polyamide 66	530x9,0	naturale - natural	100	1.000	150	79.8
9520C	Fascetta in poliammide 66 - Cable ties in polyamide 66	780x9,0	naturale - natural	100	500	228	79.8



Fascette in PA66 colore nero Cable ties in PA66 black

Imballo standard
Standard packaging





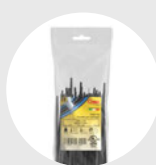

Fascetta in PA66
colore nero
Cable ties in PA66
black



CONFEZIONI da
Pz. 100
BAG of 100 pcs



Imballo standard
Standard packaging

COD. ART. ITEM CODE	DESCRIZIONE DESCRIPTION	MISURA SIZE (mm)	COLORE COLOUR	 PZ. PCS.	 PZ. IMBALLO CARTON PCS.	 MAX (mm)	 MIN (Kg)
9031	Fascetta in poliammide 66 - Cable ties in polyamide 66	80x2,4	nero - black	100	30.000	17	8.0
9051	Fascetta in poliammide 66 - Cable ties in polyamide 66	100x2,5	nero - black	100	30.000	22	8.1
9071	Fascetta in poliammide 66 - Cable ties in polyamide 66	140x2,5	nero - black	100	25.000	34	8.1
9091	Fascetta in poliammide 66 - Cable ties in polyamide 66	160x2,5	nero - black	100	20.000	40	8.1
9081	Fascetta in poliammide 66 - Cable ties in polyamide 66	200x2,5	nero - black	100	20.000	53	8.1
9131	Fascetta in poliammide 66 - Cable ties in polyamide 66	140x3,6	nero - black	100	20.000	33	18.2
9151	Fascetta in poliammide 66 - Cable ties in polyamide 66	200x3,6	nero - black	100	12.000	51	18.2
9181	Fascetta in poliammide 66 - Cable ties in polyamide 66	250x3,6	nero - black	100	12.000	67	18.2
9161	Fascetta in poliammide 66 - Cable ties in polyamide 66	290x3,6	nero - black	100	12.000	80	18.2
9171	Fascetta in poliammide 66 - Cable ties in polyamide 66	360x3,6	nero - black	100	9.000	102	18.2
9211	Fascetta in poliammide 66 - Cable ties in polyamide 66	200x4,5	nero - black	100	12.000	50	22.2
9241	Fascetta in poliammide 66 - Cable ties in polyamide 66	160x4,8	nero - black	100	10.000	38	22.2
9251	Fascetta in poliammide 66 - Cable ties in polyamide 66	175x4,8	nero - black	100	10.000	42	22.2
9261	Fascetta in poliammide 66 - Cable ties in polyamide 66	200x4,8	nero - black	100	10.000	50	22.2
9271	Fascetta in poliammide 66 - Cable ties in polyamide 66	250x4,8	nero - black	100	10.000	66	22.2
9281	Fascetta in poliammide 66 - Cable ties in polyamide 66	290x4,8	nero - black	100	10.000	78	22.2
9291	Fascetta in poliammide 66 - Cable ties in polyamide 66	360x4,8	nero - black	100	7.500	100	22.2
9301	Fascetta in poliammide 66 - Cable ties in polyamide 66	430x4,8	nero - black	100	5.000	123	25.8
9321	Fascetta in poliammide 66 - Cable ties in polyamide 66	530x4,8	nero - black	100	3.000	155	25.8
9411	Fascetta in poliammide 66 - Cable ties in polyamide 66	200x7,6	nero - black	100	5.000	49	54.4
9421	Fascetta in poliammide 66 - Cable ties in polyamide 66	250x7,6	nero - black	100	5.000	64	54.4
9431	Fascetta in poliammide 66 - Cable ties in polyamide 66	290x7,6	nero - black	100	5.000	77	54.4
9441	Fascetta in poliammide 66 - Cable ties in polyamide 66	360x7,6	nero - black	100	4.000	98	54.4
9451	Fascetta in poliammide 66 - Cable ties in polyamide 66	450x7,6	nero - black	100	3.000	127	54.4
9461	Fascetta in poliammide 66 - Cable ties in polyamide 66	530x7,6	nero - black	100	2.500	152	54.4
9471	Fascetta in poliammide 66 - Cable ties in polyamide 66	750x7,6	nero - black	100	2.000	218	54.4
9511	Fascetta in poliammide 66 - Cable ties in polyamide 66	530x9,0	nero - black	100	2.000	150	79.8
9521	Fascetta in poliammide 66 - Cable ties in polyamide 66	780x9,0	nero - black	100	1.500	228	79.8
9541	Fascetta in poliammide 66 - Cable ties in polyamide 66	1500x9,0	nero - black	100	500	460	79.8
9591	Fascetta in poliammide 66 - Cable ties in polyamide 66	1000x12,6	nero - black	100	600	295	114.0



Fascette in PA66 colore nero Cable ties in PA66 black

Imballo small
Small packaging





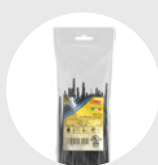

Fascetta in PA66
colore nero
Cable ties in PA6.6
black



CONFEZIONI da
Pz. 100
BAG of 100 pcs



Imballo small
Small packaging

COD. ART. ITEM CODE	DESCRIZIONE DESCRIPTION	MISURA SIZE (mm)	COLORE COLOUR	 PZ. PCS.	 PZ. IMBALLO CARTON PCS.	 MAX (mm)	 MIN (Kg)
9031C	Fascetta in poliammide 66 - Cable ties in polyamide 66	80x2,4	nero - black	100	5,000	17	8.0
9051C	Fascetta in poliammide 66 - Cable ties in polyamide 66	100x2,5	nero - black	100	5,000	22	8.1
9071C	Fascetta in poliammide 66 - Cable ties in polyamide 66	140x2,5	nero - black	100	5,000	34	8.1
9091C	Fascetta in poliammide 66 - Cable ties in polyamide 66	160x2,5	nero - black	100	5,000	40	8.1
9081C	Fascetta in poliammide 66 - Cable ties in polyamide 66	200x2,5	nero - black	100	5,000	53	8.1
9131C	Fascetta in poliammide 66 - Cable ties in polyamide 66	140x3,6	nero - black	100	5,000	33	18.2
9151C	Fascetta in poliammide 66 - Cable ties in polyamide 66	200x3,6	nero - black	100	5,000	51	18.2
9181C	Fascetta in poliammide 66 - Cable ties in polyamide 66	250x3,6	nero - black	100	5,000	67	18.2
9161C	Fascetta in poliammide 66 - Cable ties in polyamide 66	290x3,6	nero - black	100	5,000	80	18.2
9171C	Fascetta in poliammide 66 - Cable ties in polyamide 66	360x3,6	nero - black	100	4,000	102	18.2
9211C	Fascetta in poliammide 66 - Cable ties in polyamide 66	200x4,5	nero - black	100	5,000	50	22.2
9241C	Fascetta in poliammide 66 - Cable ties in polyamide 66	160x4,8	nero - black	100	5,000	38	22.2
9251C	Fascetta in poliammide 66 - Cable ties in polyamide 66	175x4,8	nero - black	100	5,000	42	22.2
9261C	Fascetta in poliammide 66 - Cable ties in polyamide 66	200x4,8	nero - black	100	5,000	50	22.2
9271C	Fascetta in poliammide 66 - Cable ties in polyamide 66	250x4,8	nero - black	100	5,000	66	22.2
9281C	Fascetta in poliammide 66 - Cable ties in polyamide 66	290x4,8	nero - black	100	5,000	78	22.2
9291C	Fascetta in poliammide 66 - Cable ties in polyamide 66	360x4,8	nero - black	100	4,000	100	22.2
9301C	Fascetta in poliammide 66 - Cable ties in polyamide 66	430x4,8	nero - black	100	3,000	123	25.8
9321C	Fascetta in poliammide 66 - Cable ties in polyamide 66	530x4,8	nero - black	100	1,000	155	25.8
9411C	Fascetta in poliammide 66 - Cable ties in polyamide 66	200x7,6	nero - black	100	2,000	49	54.4
9421C	Fascetta in poliammide 66 - Cable ties in polyamide 66	250x7,6	nero - black	100	2,000	64	54.4
9431C	Fascetta in poliammide 66 - Cable ties in polyamide 66	290x7,6	nero - black	100	2,000	77	54.4
9441C	Fascetta in poliammide 66 - Cable ties in polyamide 66	360x7,6	nero - black	100	2,000	98	54.4
9451C	Fascetta in poliammide 66 - Cable ties in polyamide 66	450x7,6	nero - black	100	1,500	127	54.4
9461C	Fascetta in poliammide 66 - Cable ties in polyamide 66	530x7,6	nero - black	100	1,000	152	54.4
9471C	Fascetta in poliammide 66 - Cable ties in polyamide 66	750x7,6	nero - black	100	500	218	54.4
9511C	Fascetta in poliammide 66 - Cable ties in polyamide 66	530x9,0	nero - black	100	1,000	150	79.8
9521C	Fascetta in poliammide 66 - Cable ties in polyamide 66	780x9,0	nero - black	100	500	228	79.8

Fascette in PA66 colore naturale Cable ties in PA66 natural

Imballo industriale
Industrial packaging



Fascetta in PA66
colore naturale
Cable ties in PA6.6
natural



CONFEZIONI da
Pz. 1000
BAG of 1000 pcs



Imballo industriale
Industrial packaging

COD. ART. ITEM CODE	DESCRIZIONE DESCRIPTION	MISURA SIZE (mm)	COLORE COLOUR	 PZ. PCS.	 PZ. IMBALLO CARTON PCS.	 MAX (mm)	 MIN (Kg)
9050M	Fascetta in poliammide 66 - Cable ties in polyamide 66	100x2,5	naturale - natural	1.000	30.000	22	8.1
9070M	Fascetta in poliammide 66 - Cable ties in polyamide 66	140x2,5	naturale - natural	1.000	25.000	34	8.1
9090M	Fascetta in poliammide 66 - Cable ties in polyamide 66	160x2,5	naturale - natural	1.000	20.000	40	8.1
9080M	Fascetta in poliammide 66 - Cable ties in polyamide 66	200x2,5	naturale - natural	1.000	20.000	53	8.1
9130M	Fascetta in poliammide 66 - Cable ties in polyamide 66	140x3,6	naturale - natural	1.000	20.000	33	18.2
9150M	Fascetta in poliammide 66 - Cable ties in polyamide 66	200x3,6	naturale - natural	1.000	12.000	51	18.2
9240M	Fascetta in poliammide 66 - Cable ties in polyamide 66	160x4,8	naturale - natural	1.000	10.000	38	22.2
9260M	Fascetta in poliammide 66 - Cable ties in polyamide 66	200x4,8	naturale - natural	1.000	10.000	50	22.2

Fascette in PA66 colore nero Cable ties in PA66 black

Imballo industriale
Industrial packaging



Fascetta in PA66
colore nero
Cable ties in PA6.6
black



CONFEZIONI da
Pz. 1000
BAG of 1000 pcs





Imballo industriale
Industrial packaging

COD. ART. ITEM CODE	DESCRIZIONE DESCRIPTION	MISURA SIZE (mm)	COLORE COLOUR	 PZ. PCS.	 PZ. IMBALLO CARTON PCS.	 MAX (mm)	 MIN (Kg)
9051M	Fascetta in poliammide 66 - Cable ties in polyamide 66	100x2,5	nero - black	1,000	30,000	22	8.1
9071M	Fascetta in poliammide 66 - Cable ties in polyamide 66	140x2,5	nero - black	1,000	25,000	34	8.1
9091M	Fascetta in poliammide 66 - Cable ties in polyamide 66	160x2,5	nero - black	1,000	20,000	40	8.1
9081M	Fascetta in poliammide 66 - Cable ties in polyamide 66	200x2,5	nero - black	1,000	20,000	53	8.1
9131M	Fascetta in poliammide 66 - Cable ties in polyamide 66	140x3,6	nero - black	1,000	20,000	33	18.2
9151M	Fascetta in poliammide 66 - Cable ties in polyamide 66	200x3,6	nero - black	1,000	12,000	51	18.2
9241M	Fascetta in poliammide 66 - Cable ties in polyamide 66	160x4,8	nero - black	1,000	10,000	38	22.2
9261M	Fascetta in poliammide 66 - Cable ties in polyamide 66	200x4,8	nero - black	1,000	10,000	50	22.2

 **Fascette in PA66 colore naturale/nero**
Cable ties in PA66 natural/black

Confezione da 50pz
50pcs packaging

 Fascetta in PA66 colore naturale/nero
Cable ties in PA66 natural/black

 CONFEZIONI da Pz. 50
BAG of 50 pcs

 Imballo standard
Standard packaging

COD. ART. ITEM CODE	DESCRIZIONE DESCRIPTION	MISURA SIZE (mm)	COLORE COLOUR	 PZ. PCS.	 PZ. IMBALLO CARTON PCS.	 MAX (mm)	 MIN (Kg)
9130Y	Fascetta in poliammide 66 - Cable ties in polyamide 66	140x3,6	naturale - natural	50	20.000	33	18.2
9131Y	Fascetta in poliammide 66 - Cable ties in polyamide 66	140x3,6	nero - black	50	20.000	33	18.2
9210Y	Fascetta in poliammide 66 - Cable ties in polyamide 66	200x4,5	naturale - natural	50	12.000	50	22.2
9211Y	Fascetta in poliammide 66 - Cable ties in polyamide 66	200x4,5	nero - black	50	12.000	50	22.2
9280Y	Fascetta in poliammide 66 - Cable ties in polyamide 66	290x4,8	naturale - natural	50	10.000	78	22.2
9281Y	Fascetta in poliammide 66 - Cable ties in polyamide 66	290x4,8	nero - black	50	10.000	78	22.2

 **Fascette in PA66 colore naturale/nero**
Cable ties in PA66 natural/black

Confezione da 50pz
50pcs packaging

 Fascetta in PA66 colore naturale/nero
Cable ties in PA6.6 natural/black

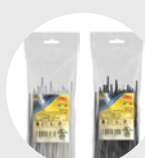
 CONFEZIONI da Pz. 50
BAG of 50 pcs

 Imballo small
Small packaging

COD. ART. ITEM CODE	DESCRIZIONE DESCRIPTION	MISURA SIZE (mm)	COLORE COLOUR	 PZ. PCS.	 PZ. IMBALLO CARTON PCS.	 MAX (mm)	 MIN (Kg)
9130YC	Fascetta in poliammide 66 - Cable ties in polyamide 66	140x3,6	naturale - natural	50	5.000	33	18.2
9131YC	Fascetta in poliammide 66 - Cable ties in polyamide 66	140x3,6	nero - black	50	5.000	33	18.2
9210YC	Fascetta in poliammide 66 - Cable ties in polyamide 66	200x4,5	naturale - natural	50	5.000	50	22.2
9211YC	Fascetta in poliammide 66 - Cable ties in polyamide 66	200x4,5	nero - black	50	5.000	50	22.2
9280YC	Fascetta in poliammide 66 - Cable ties in polyamide 66	290x4,8	naturale - natural	50	5.000	78	22.2
9281YC	Fascetta in poliammide 66 - Cable ties in polyamide 66	290x4,8	nero - black	50	5.000	78	22.2

FASCETTE - CABLE TIES

Fascette standard colorate

FASCETTE IN PA66 COLORATE

Standard coloured cable ties

CABLE TIES IN PA66 DIFFERENT COLOURS

Fascette di cablaggio prodotte in nylon PA6.6 nei colori sotto esposti, sono suggerite per applicazioni con esigenze estetiche o dove sia necessario riconoscere e/o differenziare. Attraverso il sistema d'aggancio tra dente e cremagliera permettono il fissaggio di vari diametri. Facilmente installabili manualmente. In caso di applicazione con l'utilizzo di utensile per il fissaggio si raccomanda la corretta regolazione di tensione dello stesso proporzionata alla dimensione della fascetta.

Colori sempre disponibili giallo, rosso, verde, blu, arancio, marrone, rosa e grigio. Altri colori e misure disponibili su richiesta.

Wiring cable ties made of nylon PA6.6, in the following colors, are suggested for applications with an attention to appearance or where identification and/or distinction are necessary. The hooking system between the pawl and the rack permits the fixing of various diameters. Easy manual installation. In case of a non-manual installation, please make sure your tool is regulated for a stress in proportion to the size of the cable tie.

Colors always available: yellow, red, green, blue, orange, brown, pink and gray. Other colors and sizes available on demand.

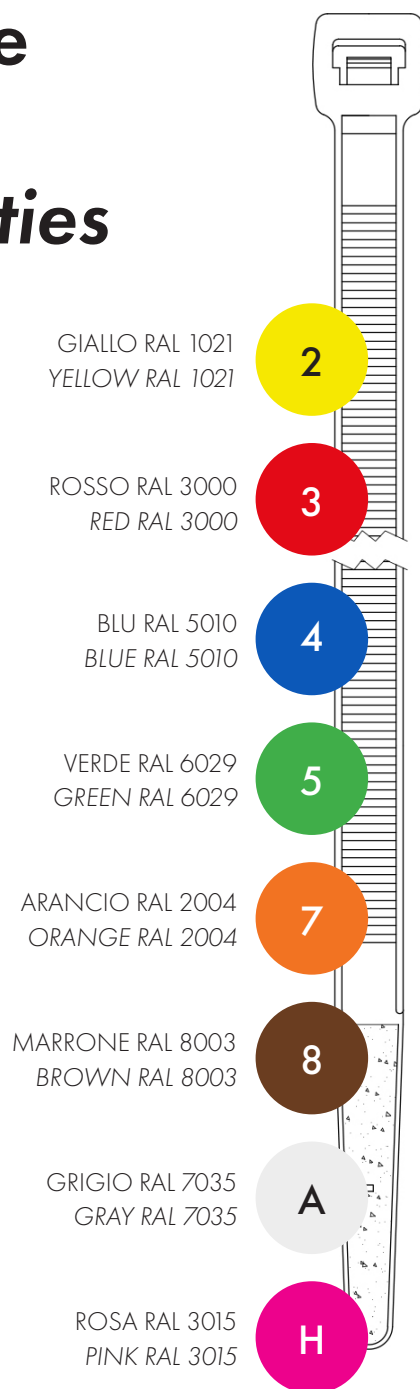

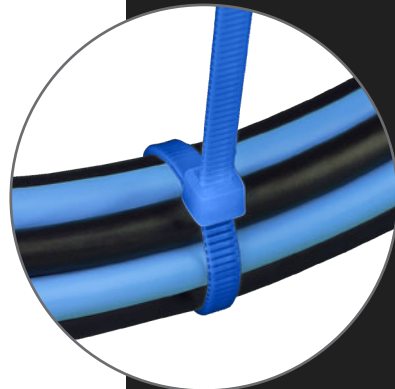
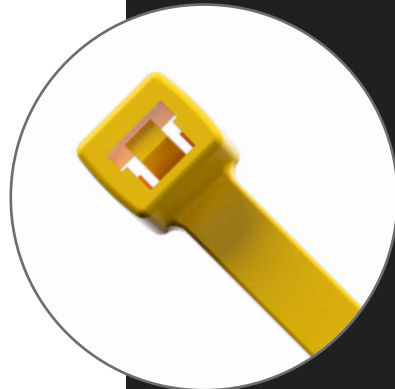
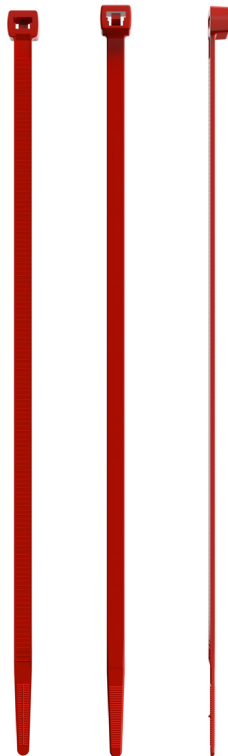
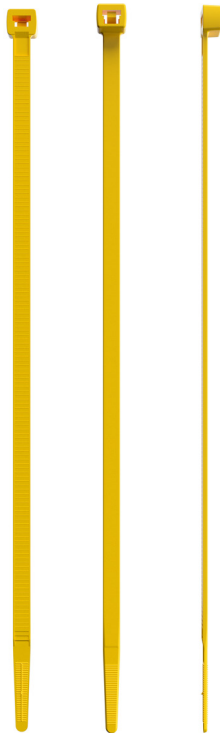

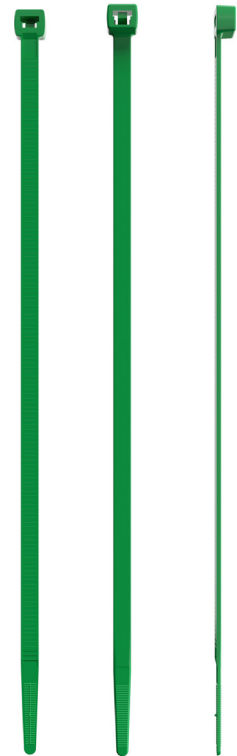
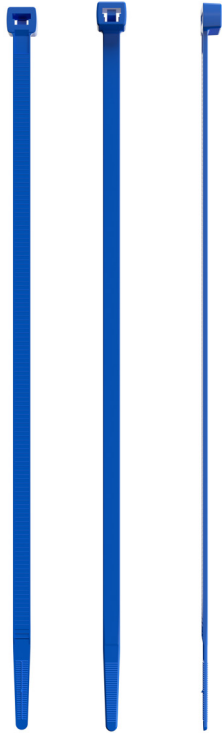

**Stampa e personalizzazioni disponibili su richiesta.
Printable customizations available on request.**

Diamo la possibilità di personalizzare le fascette di cablaggio stampando su di esse lettere, numeri, numeri seriali, barcode e loghi in base alle esigenze del Cliente. La stampa risulta chiara e ben leggibile. È possibile stampare sul corpo della fascetta e sulle targhette delle fascette d'identificazione (pagine 34-39) e delle fascette a sigillo (pagine 50-55). Per maggiori informazioni contattare la sede.

There is the possibility to customize the cable ties by printing letters, numbers, sequential numbers, barcode and logos on them according to the customer's needs. The print result is clear and well readable. It is possible to print on the body of the cable ties and on the plate of the identification cable ties type 1, 2 and 3 (pages 34-39) and of the seal type 1, 2 and 3 (pages 50-55). For more information please contact us.

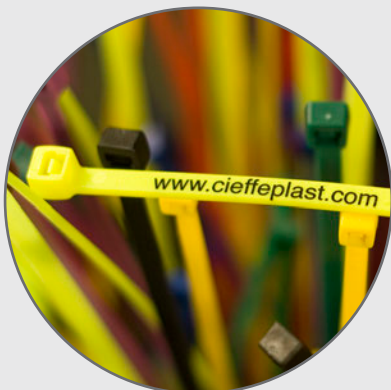

 **Fascette in PA66 colorate**
Cable ties in PA66 different colours

Imballo standard
Standard packaging

	Fascetta in PA66 colorate Cable ties in PA6.6 coloured		CONFEZIONI da Pz. 100 BAG of 100 pcs		Imballo standard Standard packaging		
COD. ART. ITEM CODE	DESCRIZIONE DESCRIPTION	MISURA SIZE (mm)	COLORE COLOUR	PZ. PCS.	PZ. IMBALLO CARTON PCS.	MAX (mm)	MIN (Kg)
905*	Fascetta in poliammide 66 Cable ties in polyamide 66	100x2,5	*	100	30,000	22	8.1
913*	Fascetta in poliammide 66 Cable ties in polyamide 66	140x3,6	*	100	20,000	33	18.2
915*	Fascetta in poliammide 66 Cable ties in polyamide 66	200x3,6	*	100	12,000	51	18.2
926*	Fascetta in poliammide 66 Cable ties in polyamide 66	200x4,8	*	100	10,000	50	22.2
928*	Fascetta in poliammide 66 Cable ties in polyamide 66	290x4,8	*	100	10,000	78	22.2

 **Fascette in PA66 colorate**
Cable ties in PA66 different colours

Imballo small
Small packaging

	Fascetta in PA66 colorate Cable ties in PA6.6 coloured		CONFEZIONI da Pz. 100 BAG of 100 pcs		Imballo small Small packaging		
COD. ART. ITEM CODE	DESCRIZIONE DESCRIPTION	MISURA SIZE (mm)	COLORE COLOUR	PZ. PCS.	PZ. IMBALLO CARTON PCS.	MAX (mm)	MIN (Kg)
905*C	Fascetta in poliammide 66 Cable ties in polyamide 66	100x2,5	*	100	5,000	22	8.1
913*C	Fascetta in poliammide 66 Cable ties in polyamide 66	140x3,6	*	100	5,000	33	18.2
915*C	Fascetta in poliammide 66 Cable ties in polyamide 66	200x3,6	*	100	5,000	51	18.2
926*C	Fascetta in poliammide 66 Cable ties in polyamide 66	200x4,8	*	100	5,000	50	22.2
928*C	Fascetta in poliammide 66 Cable ties in polyamide 66	290x4,8	*	100	5,000	78	22.2

*Inserire il numero colore come ultimo numero al codice

*Insert the colour number requested as per last code number

Giallo RAL 1021 Yellow RAL 1021	Rosso RAL 3000 Red RAL 3000	Blu RAL 5010 Blue RAL 5010	Verde RAL 6029 Green RAL 6029	Arancio RAL 2004 Orange RAL 2004	Marrone RAL 8003 Brown RAL 8003	Grigio RAL 7035 Gray RAL 7035	Rosa RAL 3015 Pink RAL 3015
2	3	4	5	7	8	A	H

FASCETTE - CABLE TIES

Fascette stabilizzate UV

FASCETTE IN NYLON PA66 STABILIZZATE UV

UV stabilized cable ties

UV STABILIZED CABLE TIES IN PA66 NYLON

Fascette di cablaggio prodotte in PA6.6 stabilizzato ai raggi UV colore verde RAL 6005 e nero, sono suggerite per applicazioni all'esterno dove si vuole ottenere la massima durata nel tempo ai raggi UV. Attraverso il sistema d'aggancio tra dente e cremagliera permettono il fissaggio di vari diametri.

Facilmente installabili manualmente. In caso di applicazione con l'utilizzo di utensile si raccomanda la corretta regolazione di tensione dello stesso proporzionata alla dimensione della fascetta.

Altre misure disponibili su richiesta

Wiring cable ties made of PA6.6, UV rays stabilized, green RAL 6005 and black color, suggested for outdoor applications where the maximum long lasting resistance to UV rays is required. The hooking system between the pawl and the rack permits the fixing of various diameters. Easy manual installation. In case of a non manual installation, please make sure your tool is regulated for a stress in proportion to the size of the cable tie.

Other sizes available on demand

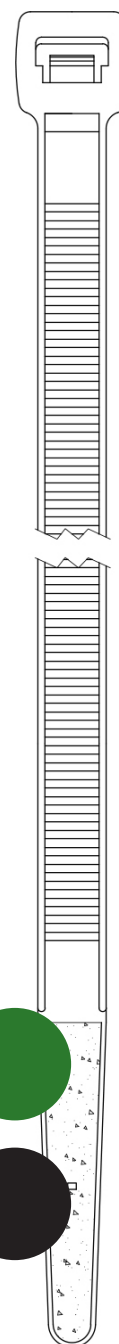

VERDE UV
UV GREEN

UV NERO
UV BLACK

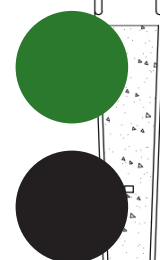



Fascette stabilizzate ai raggi UV

UV stabilized cable ties



Fascette stabilizzate ai raggi UV
UV stabilized cable ties



CONFEZIONI da
Pz. 100
BAG of 100 pcs



Imballo
Packaging

COD. ART. ITEM CODE	DESCRIZIONE DESCRIPTION	MISURA SIZE (mm)	COLORE COLOUR	PZ. PCS.	PZ. IMBALLO CARTON PCS.	MAX (mm)	MIN (Kg)
9130UV	Fascetta in poliammide 66 UV Cable ties in polyamide 66 UV	140x3,6	verde RAL 6005 green RAL 6005	100	5,000	33	18.2
9260UV	Fascetta in poliammide 66 UV Cable ties in polyamide 66 UV	200x4,8	verde RAL 6005 green RAL 6005	100	5,000	50	22.2
9280UV	Fascetta in poliammide 66 UV Cable ties in polyamide 66 UV	290x4,8	verde RAL 6005 green RAL 6005	100	5,000	78	22.2
9420UV	Fascetta in poliammide 66 UV Cable ties in polyamide 66 UV	250x7,6	verde RAL 6005 green RAL 6005	100	5,000	64	54.4
9131UV	Fascetta in poliammide 66 UV Cable ties in polyamide 66 UV	140x3,6	nero black	100	5,000	33	18.2
9261UV	Fascetta in poliammide 66 UV Cable ties in polyamide 66 UV	200x4,8	nero black	100	5,000	50	22.2
9281UV	Fascetta in poliammide 66 UV Cable ties in polyamide 66 UV	290x4,8	nero black	100	5,000	78	22.2
9421UV	Fascetta in poliammide 66 UV Cable ties in polyamide 66 UV	250x7,6	nero black	100	5,000	64	54.4

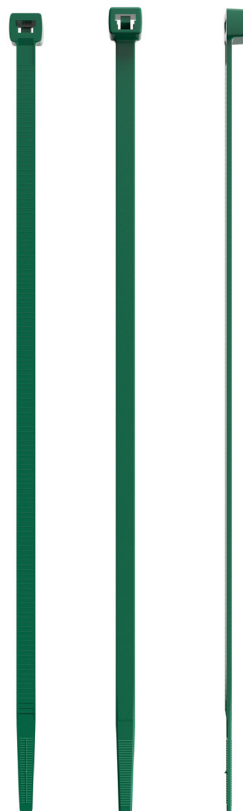

FASCETTE - CABLE TIES

Fascette termoresistenti

FASCETTE IN PA66 TERMORESISTENTI

Heat stabilized cable ties

HEAT STABILIZED CABLE TIES IN PA66 NYLON

Fascette di cablaggio prodotte in nylon PA6.6 stabilizzato alle alte temperature colore rosso rubino RAL 3003, sono suggerite per applicazioni esposte ad alte temperature. Attraverso il sistema d'aggancio tra dente e cremagliera permettono il fissaggio di vari diametri.

- Temperatura massima in uso continuo 125°.
- Temperatura massima ammissibile per brevi periodi 150°.
- Facilmente installabili manualmente.

In caso di applicazione con l'utilizzo di utensile si raccomanda la corretta regolazione di tensione dello stesso proporzionata alla dimensione della fascetta.

Wiring cable ties made of nylon PA6.6, high heat stabilized, red ruby RAL 3003 color, are suggested for applications exposed to high heat. The hooking system between the pawl and the rack permits the fixing of various diameters.

- *Maximum heat for continuous use 125°C.*
- *Maximum heat acceptable for brief periods 150°C.*
- *Easy manual installation.*

In case of a non manual installation, please make sure your tool is regulated for a stress in proportion to the size of the cable tie.

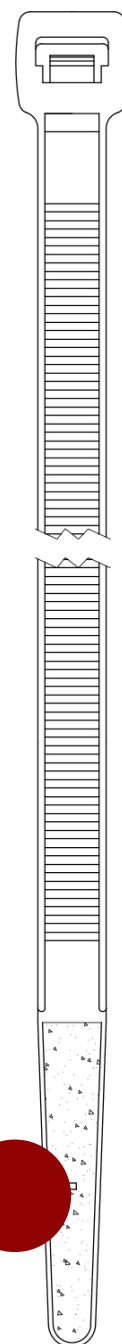

ROSSO RUBINO
RUBY RED



Fascette termoresistenti Heat stabilized cable ties







Fascette termoresistenti
Heat stabilized cable ties



CONFEZIONI da
Pz. 100
BAG of 100 pcs



Imballo
Packaging

COD. ART. ITEM CODE	DESCRIZIONE DESCRIPTION	MISURA SIZE (mm)	COLORE COLOUR	 PZ. PCS.	 PZ. IMBALLO CARTON PCS.	 MAX (mm)	 MIN (Kg)
9058TR	Fascetta in PA66 termoresistente Cable ties in PA66 heat-stabilized	100x2,5	rosso rubino RAL 3003 ruby red RAL 3003	100	5,000	22	8.1
9078TR	Fascetta in PA66 termoresistente Cable ties in PA66 heat-stabilized	140x2,5	rosso rubino RAL 3003 ruby red RAL 3003	100	5,000	34	8.1
9098TR	Fascetta in PA66 termoresistente Cable ties in PA66 heat-stabilized	160x2,5	rosso rubino RAL 3003 ruby red RAL 3003	100	5,000	40	8.1
9138TR	Fascetta in PA66 termoresistente Cable ties in PA66 heat-stabilized	140x3,6	rosso rubino RAL 3003 ruby red RAL 3003	100	5,000	33	18.2
9158TR	Fascetta in PA66 termoresistente Cable ties in PA66 heat-stabilized	200x3,6	rosso rubino RAL 3003 ruby red RAL 3003	100	5,000	51	18.2
9168TR	Fascetta in PA66 termoresistente Cable ties in PA66 heat-stabilized	290x3,6	rosso rubino RAL 3003 ruby red RAL 3003	100	5,000	80	18.2
9178TR	Fascetta in PA66 termoresistente Cable ties in PA66 heat-stabilized	360x3,6	rosso rubino RAL 3003 ruby red RAL 3003	100	4,000	102	18.2
9248TR	Fascetta in PA66 termoresistente Cable ties in PA66 heat-stabilized	160x4,8	rosso rubino RAL 3003 ruby red RAL 3003	100	5,000	38	22.2
9268TR	Fascetta in PA66 termoresistente Cable ties in PA66 heat-stabilized	200x4,8	rosso rubino RAL 3003 ruby red RAL 3003	100	5,000	50	22.2
9278TR	Fascetta in PA66 termoresistente Cable ties in PA66 heat-stabilized	250x4,8	rosso rubino RAL 3003 ruby red RAL 3003	100	5,000	66	22.2
9288TR	Fascetta in PA66 termoresistente Cable ties in PA66 heat-stabilized	290x4,8	rosso rubino RAL 3003 ruby red RAL 3003	100	5,000	78	22.2
9298TR	Fascetta in PA66 termoresistente Cable ties in PA66 heat-stabilized	360x4,8	rosso rubino RAL 3003 ruby red RAL 3003	100	4,000	100	22.2
9308TR	Fascetta in PA66 termoresistente Cable ties in PA66 heat-stabilized	430x4,8	rosso rubino RAL 3003 ruby red RAL 3003	100	3,000	123	25.8
9328TR	Fascetta in PA66 termoresistente Cable ties in PA66 heat-stabilized	530x4,8	rosso rubino RAL 3003 ruby red RAL 3003	100	1,000	155	25.8
9428TR	Fascetta in PA66 termoresistente Cable ties in PA66 heat-stabilized	250x7,6	rosso rubino RAL 3003 ruby red RAL 3003	100	2,000	64	54.4
9448TR	Fascetta in PA66 termoresistente Cable ties in PA66 heat-stabilized	360x7,6	rosso rubino RAL 3003 ruby red RAL 3003	100	2,000	98	54.4

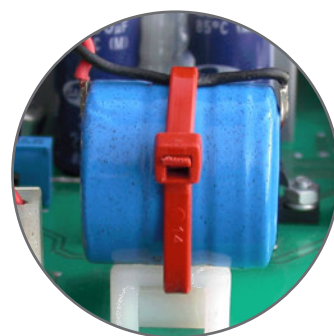

FASCETTE - CABLE TIES

Fascette riapribili

FASCETTE IN PA6.6 RIAPRIBILI

Releasable cable ties

RELEASABLE CABLE TIES IN PA66

Fascette di cablaggio prodotte in PA6.6 colore naturale e nero, sono suggerite in naturale per applicazioni in ambienti interni ed in nero per applicazioni in ambiente esterno. Il grande pulsante di sgancio le rende molto pratiche per la chiusura e riapertura delle stesse permettendone il riutilizzo.

Facilmente installabili manualmente. Possono essere usate per fissaggi provvisori come chiusure di bobine di tubo o matasse di cavo, per preparazione di cablaggi mantenendo uniti i cavi prima del fissaggio definitivo, o per uso domestico come chiusura e riapertura di sacchetti.

Wiring cable ties made of PA6.6, in natural and black colors, are suggested in natural color for indoor applications, and in black color for outdoor applications. The big pawl release button make them highly convenient for their closure and release, so they can be used again and again.

Easy manual installation. They can be used for temporary fixing such as the closure of tube or wire reels, wiring dispositions keeping all the cables together before the final fixing, or for a domestic use such as the closure and release of bags.

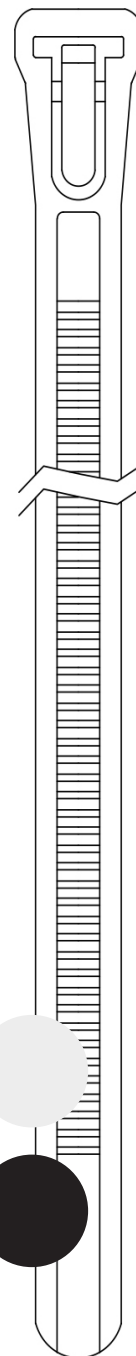

NATURALE
NATURAL

NERO
BLACK

Fascette riapribili Releasable cable ties







Fascette riapribili
Releasable cable ties



CONFEZIONI da
Pz. 100
BAG of 100 pcs



Imballo
Packaging

COD. ART. ITEM CODE	DESCRIZIONE DESCRIPTION	MISURA SIZE (mm)	COLORE COLOUR	 PZ. PCS.	 PZ. IMBALLO CARTON PCS.	 MAX (mm)	 MIN (Kg)
962010	Fascetta riapribile - Releasable cable ties	150x4,5	naturale - natural	100	1,000	35	22.2
962011	Fascetta riapribile - Releasable cable ties	200x4,5	naturale - natural	100	1,000	50	22.2
962012	Fascetta riapribile - Releasable cable ties	300x4,5	naturale - natural	100	1,000	80	22.2
962001	Fascetta riapribile - Releasable cable ties	150x7,6	naturale - natural	100	1,000	35	22.2
962002	Fascetta riapribile - Releasable cable ties	200x7,6	naturale - natural	100	1,000	50	22.2
962003	Fascetta riapribile - Releasable cable ties	250x7,6	naturale - natural	100	1,000	66	22.2
962004	Fascetta riapribile - Releasable cable ties	300x7,6	naturale - natural	100	1,000	80	22.2
962005	Fascetta riapribile - Releasable cable ties	370x7,6	naturale - natural	100	1,000	102	22.2
962110	Fascetta riapribile - Releasable cable ties	150x4,5	nero - black	100	1,000	35	22.2
962111	Fascetta riapribile - Releasable cable ties	200x4,5	nero - black	100	1,000	50	22.2
962112	Fascetta riapribile - Releasable cable ties	300x4,5	nero - black	100	1,000	80	22.2
962101	Fascetta riapribile - Releasable cable ties	150x7,6	nero - black	100	1,000	35	22.2
962102	Fascetta riapribile - Releasable cable ties	200x7,6	nero - black	100	1,000	50	22.2
962103	Fascetta riapribile - Releasable cable ties	250x7,6	nero - black	100	1,000	66	22.2
962104	Fascetta riapribile - Releasable cable ties	300x7,6	nero - black	100	1,000	80	22.2
962105	Fascetta riapribile - Releasable cable ties	370x7,6	nero - black	100	1,000	102	22.2

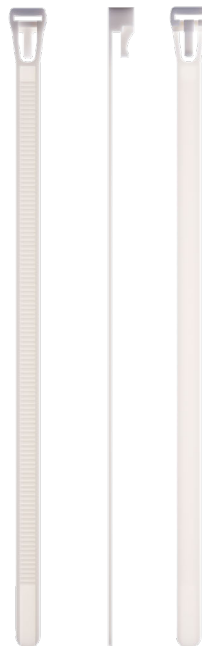

FASCETTE - CABLE TIES

Fascette d'installazione PA66

FASCETTE D'INSTALLAZIONE IN PA66

Installation cable ties PA66

INSTALLATION CABLE TIES IN PA66

Fascette di cablaggio prodotte in PA6.6 colore nero, sono suggerite anche per applicazioni all'esterno. Si caratterizzano per il sistema d'aggancio tra testa e cremagliera esterna ad inserimento parallelo, con testa piatta e senza sporgenze che permette una maggiore superficie di appoggio sul prodotto da fissare.

- Codice 979101 testina singola.
- Codici 979102-979103-979104-979105-979106 testina doppia.
- Per applicazioni su supporti in muratura si può utilizzare il tassello per fascette cod. 9771, pagina 68.
- Installabili anche manualmente, si consiglia l'utilizzo di un utensile codice 8523 o 8543, pagina 48.

Wiring cable ties made of PA6.6, black color, are suggested for outdoor applications too. Characterized by the hooking system between the head and the outside rack with parallel insertion, with flat head and no protrusions they permit a wider surface of support on the product to be fixed.

- Single locking head Code 979101.
- Double locking head Codes 979102-979103-979104-979105-979106.
- For wall applications our wall plug Cod. 9771, page 68, can be used.
- Manual installation also being possible, we suggest the use of a tool, code 8523 or 8543, page 48.

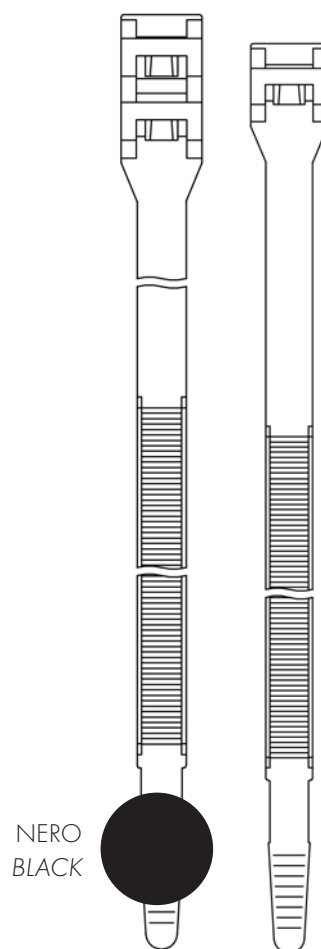



Fascette d'installazione PA66 Installation cable ties PA66







Fascette
d'installazione PA66
Installation cable
ties PA66



CONFEZIONI da
Pz. 100
BAG of 100 pcs



Imballo
Packaging

COD. ART. ITEM CODE	DESCRIZIONE DESCRIPTION	MISURA SIZE (mm)	COLORE COLOUR	 PZ. PCS.	 PZ. IMBALLO CARTON PCS.	 MAX (mm)	 MIN (Kg)
979101	Fascetta di installazione in PA66 Installation cable ties in PA66	200x9	nero black	100	5,000	40	36
979102	Fascetta di installazione in PA66 Installation cable ties in PA66	290x9	nero black	100	3,000	63	55
979103	Fascetta di installazione in PA66 Installation cable ties in PA66	380x9	nero black	100	2,000	85	55
979104	Fascetta di installazione in PA66 Installation cable ties in PA66	510x9	nero black	100	1,000	142	55
979105	Fascetta di installazione in PA66 Installation cable ties in PA66	610x9	nero black	100	1,000	174	55
979106	Fascetta di installazione in PA66 Installation cable ties in PA66	760x9	nero black	100	500	214	55



Testina singola
Single locking head

Codice/Code
979101

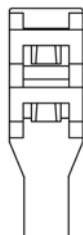

Testina doppia
Double locking head

Codici/Codes
979102, 979103, 979104,
979105, 979106

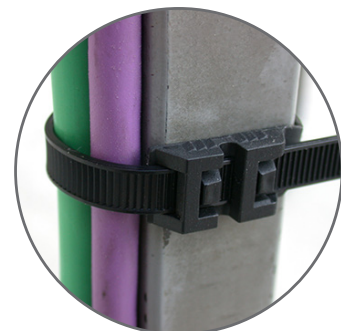

Cod.8523



Cod.8543

FASCETTE - CABLE TIES

Fascette d'installazione PA12

FASCETTE D'INSTALLAZIONE IN PA12

Installation cable ties PA12

INSTALLATION CABLE TIES IN PA12

Fascette di cablaggio prodotte in PA12 colore nero, offrono un'elevata resistenza ai raggi UV, agli agenti atmosferici e alle basse temperature. Sono suggerite per applicazioni all'esterno anche in ambienti marini.

Si caratterizzano per un sistema d'aggancio molto stabile tra testa e cremagliera esterna ad inserimento parallelo, con testa piatta e senza sporgenze che permette una maggiore superficie di appoggio sul prodotto da fissare.

- Codice 9801 testina singola.
- Codici 9811-9821 testina doppia.
- Per applicazioni su supporti in muratura si può utilizzare il tassello cod. 9771, pagina 68.
- Per l'installazione è necessario l'uso della pinza per il serraggio fascette cod. 8523 o 8543 (vedi sezione utensili per fascette pagina 48).

Wiring cable ties made of PA12, black color, offer a high resistance to UV rays, to atmospheric agents and to low temperature. They are suggested for outdoor applications, also sea environment.

Characterized by a highly stable hooking system between the head and the outside rack with parallel insertion, with flat head and no protrusions which permit a wider surface of support on the product to be fixed.

- Single head Code 9801.
- Double head Codes 9811-9821.
- For wall applications our wall plug Cod. 9771, page 68, can be used.
- For the installation it is necessary the use of pliers for cable ties, Code 8523 or 8543 (see the section "tools for cable ties" page 48).

NERO
BLACK

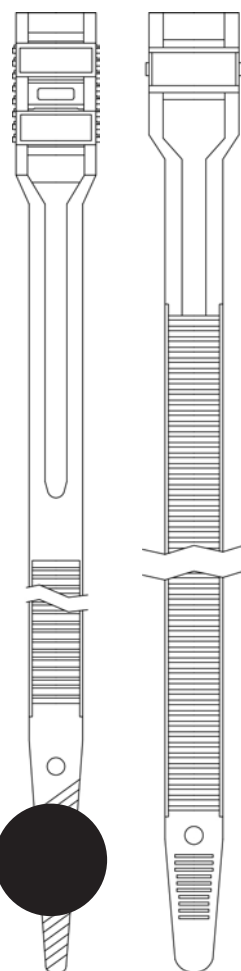



Fascette d'installazione PA12 Installation cable ties PA12







Fascette
d'installazione PA12
*Installation cable
ties PA12*



CONFEZIONI da
Pz. 100
BAG of 100 pcs



Imballo
Packaging

COD. ART. ITEM CODE	DESCRIZIONE DESCRIPTION	MISURA SIZE (mm)	COLORE COLOUR	 PZ. PCS.	 PZ. IMBALLO CARTON PCS.	 MAX (mm)	 MIN (Kg)
9801	Fascetta di installazione in PA12 <i>Installation cable ties in PA12</i>	180x9	nero <i>black</i>	100	5,000	40	35
9811	Fascetta di installazione in PA12 <i>Installation cable ties in PA12</i>	260x9	nero <i>black</i>	100	3,000	53	51
9821	Fascetta di installazione in PA12 <i>Installation cable ties in PA12</i>	360x9	nero <i>black</i>	100	2,000	83	51

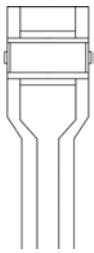

Testina singola
Single locking head

Codice/Code
9801

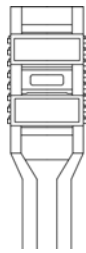

Testina doppia
Double locking head

Codici/Codes
9811, 9821

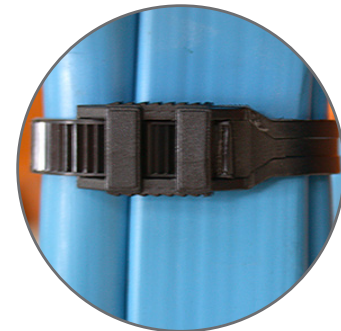

Cod.8523



Cod.8543

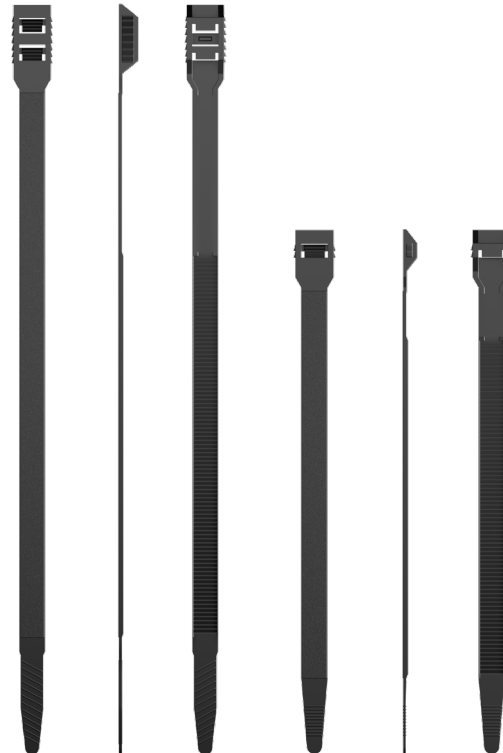

FASCETTE - CABLE TIES

Fascette d'identificazione TIPO 1

FASCETTE D'IDENTIFICAZIONE IN PA66 TIPO1

Cable ties with marker plate TYPE 1

CABLE TIES WITH MARKER PLATE IN PA66 TYPE 1

Fascette di cablaggio prodotte in PA6.6 colore naturale, sono suggerite per il fissaggio e l'identificazione su piccoli fasci di cavi. Attraverso il sistema d'aggancio tra dente e cremagliera permettono il fissaggio di vari diametri.

La targhetta con dimensioni 25,4×8 mm fa parte del corpo della fascetta, è parallela al particolare che viene fissato e la sua superficie è scrivibile con pennarello.

Wiring cable ties made of nylon PA6.6, natural color, are suggested for the fixing and identification of small bundle of cables. The hooking system between the pawl and the rack permits the fixing of various diameters. The marker plate, 25,4×8 mm, is part of the body of the tie, perpendicular to what is being fixed. Its surface can be written with a marker pen.

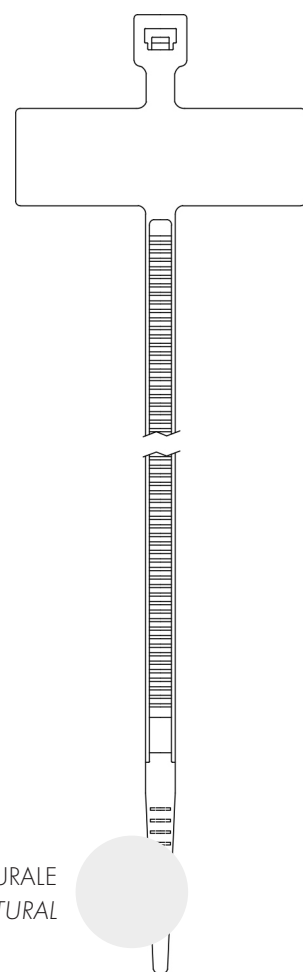

NATURALE
NATURAL



Fascette d'identificazione tipo 1 Cable ties with marker plate type 1







Fascette
d'identificazione tipo 1
Cable ties with marker
plate type 1



CONFEZIONI da
Pz. 100
BAG of 100 pcs



Imballo
Packaging

COD. ART. ITEM CODE	DESCRIZIONE DESCRIPTION	MISURA SIZE (mm)	COLORE COLOUR	 PZ. PCS.	 PZ. IMBALLO CARTON PCS.	 MAX (mm)	 MIN (Kg)
9600	Fascette d'identificazione con targhetta SOTTO testa - tipo 1 Cable ties with UNDER head marker plate - type 1	100x2,5	naturale natural	100	5000	15	8.1
9610	Fascette d'identificazione con targhetta SOTTO testa - tipo 1 Cable ties with UNDER head marker plate - type 1	200x2,5	naturale natural	100	5000	53	8.1

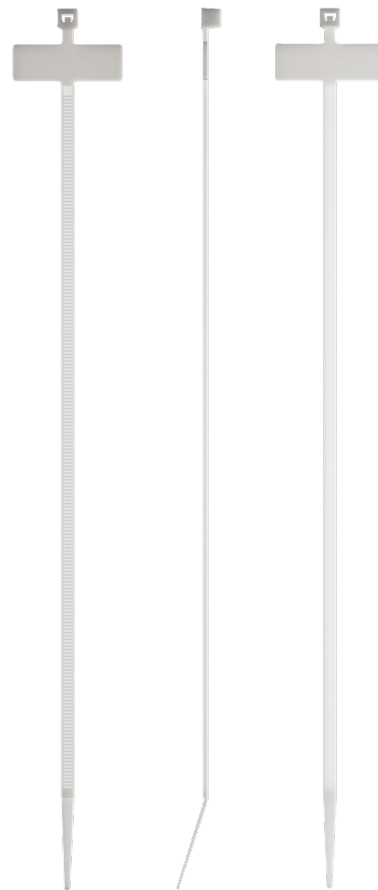

FASCETTE - CABLE TIES

Fascette d'identificazione TIPO 2

FASCETTE D'IDENTIFICAZIONE IN PA66 TIPO2

Cable ties with marker plate TYPE 2

CABLE TIES WITH MARKER PLATE IN PA66 TYPE 2

Fascette di cablaggio prodotte in PA6.6 colore naturale, sono suggerite per il fissaggio e l'identificazione su cablaggi elettrici. Attraverso il sistema d'aggancio tra dente e cremagliera permettono il fissaggio di vari diametri.

La targhetta con dimensioni 20,4×9 mm è esterna al corpo della fascetta, è parallela al particolare che viene fissato e la sua superficie è scrivibile con pennarello.

Wiring cable ties made of nylon PA6.6, natural color, are suggested for the fixing and identification of electrical wirings. The hooking system between the pawl and the rack permits the fixing of various diameters. The marker plate, 20,4×9 mm, is placed outside the body of the tie, parallel to what is being fixed. Its surface can be written with a marker pen.

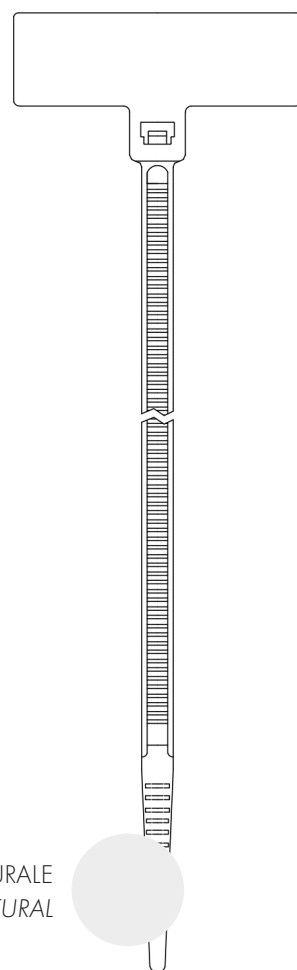

NATURALE
NATURAL



Fascette d'identificazione tipo2 Cable ties with marker plate type2



Fascette d'identificazione tipo2
Cable ties with marker plate type2



CONFEZIONI da
Pz. 100
BAG of 100 pcs



Imballo
Packaging

COD. ART. ITEM CODE	DESCRIZIONE DESCRIPTION	MISURA SIZE (mm)	COLORE COLOUR	PZ. PCS.	PZ. IMBALLO CARTON PCS.	MAX (mm)	MIN (Kg)
961001	Fascette d'identificazione con targhetta SOPRA testa - tipo 2 Cable ties with UP head marker plate - type 2	110x2.5	naturale natural	100	5000	18	8.1
961002	Fascette d'identificazione con targhetta SOPRA testa - tipo 2 Cable ties with UP head marker plate - type 2	210x2.5	naturale natural	100	5000	50	8.1

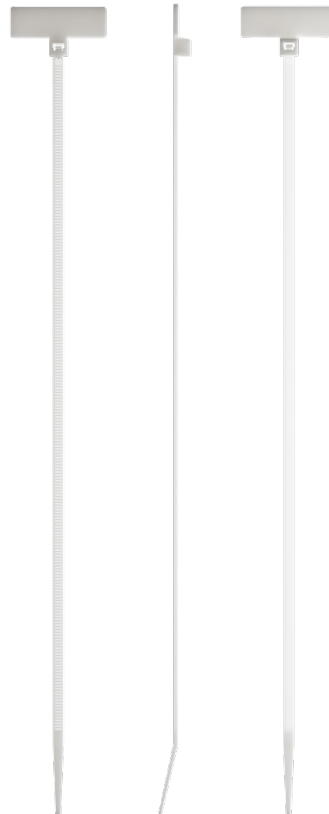

FASCETTE - CABLE TIES

Fascette d'identificazione TIPO 3

FASCETTE D'IDENTIFICAZIONE IN PA66 TIPO3

Cable ties with marker plate TYPE 3

CABLE TIES WITH MARKER PLATE IN PA66 TYPE3

Fascette di cablaggio prodotte in PA6.6 colore naturale, sono suggerite per il fissaggio e l'identificazione su grossi fasci di cavi. Attraverso il sistema d'aggancio tra dente e cremagliera permettono il fissaggio di vari diametri. La targhetta con dimensioni 13×28 mm fa parte del corpo della fascetta, è perpendicolare al particolare che viene fissato. La sua superficie è scrivibile con pennarello.

Wiring cable ties made of nylon PA6.6, natural color, are suggested for the fixing and identification of big bundle of cables. The hooking system between the pawl and the rack permits the fixing of various diameters. The marker plate, 13×28 mm, is part of the body of the tie, perpendicular to what is being fixed.

Its surface can be written with a marker pen.

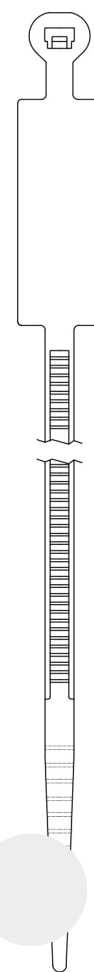

NATURALE
NATURAL



Fascette d'identificazione tipo3 Cable ties with marker plate type3



Fascette
d'identificazione tipo3
Cable ties with marker
plate type3



CONFEZIONI da
Pz. 100
BAG of 100 pcs



Imballo
Packaging

COD. ART. ITEM CODE	DESCRIZIONE DESCRIPTION	MISURA SIZE (mm)	COLORE COLOUR	 PZ. PCS.	 PZ. IMBALLO CARTON PCS.	 MAX (mm)	 MIN (Kg)
961005	Fascette d'identificazione con targhetta SOTTO testa - tipo 3 Cable ties with UNDER head marker plate - type 3	190x4,8	naturale natural	100	3000	46	22.2
961006	Fascette d'identificazione con targhetta SOTTO testa - tipo 3 Cable ties with UNDER head marker plate - type 3	270x4,8	naturale natural	100	3000	65	22.2

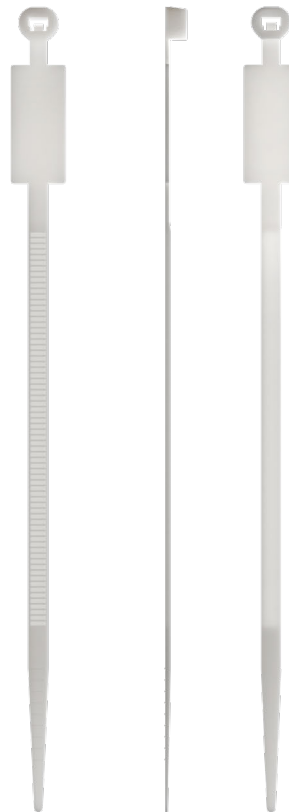

FASCETTE - CABLE TIES

Fascette con occhiello

FASCETTE CON OCCHIELLO IN PA66

Mounting cable ties

MOUNTING CABLE TIES IN PA66

Fascette di cablaggio prodotte in PA6.6 colore naturale, sono suggerite per fissaggi attraverso una vite su qualsiasi supporto come un pannello. Consigliate per quadristica, fissaggi temporanei e cablaggi speciali.

Attraverso il sistema d'aggancio tra dente e cremagliera permettono il fissaggio di vari diametri.

In caso di applicazione con l'utilizzo di utensile si raccomanda la corretta regolazione di tensione dello stesso proporzionata alla dimensione della fascetta.

Wiring cable ties made of PA6.6, natural color, are suggested for screw fixing on any kind of support, as a panel. Ideal for switchboards, temporary fixing and special wirings.

The hooking system between the pawl and the rack permits the fixing of various diameters.

In case of a non-manual installation, please make sure your tool is regulated for a stress in proportion to the size of the cable tie.

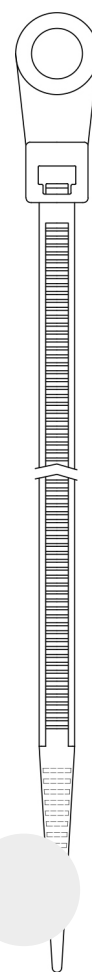

NATURALE
NATURAL

Fascette con occhiello Mounting cable ties







Fascette
con occhiello
Mounting
cable ties



CONFEZIONI da
Pz. 100
BAG of 100 pcs



Imballo
Packaging

COD. ART. ITEM CODE	DESCRIZIONE DESCRIPTION	MISURA SIZE (mm)	COLORE COLOUR	 PZ. PCS.	 PZ. IMBALLO CARTON PCS.	 MAX (mm)	 MIN (Kg)	 FORO HOLE (mm)
963001	Fascetta con occhiello Mounting cable ties	100x2,5	naturale natural	100	5,000	22	8.1	3.2
963002	Fascetta con occhiello Mounting cable ties	150x3,6	naturale natural	100	5,000	32	18.2	4.2
963003	Fascetta con occhiello Mounting cable ties	200x4,8	naturale natural	100	4,000	50	22.2	5.5
963004	Fascetta con occhiello Mounting cable ties	300x4,8	naturale natural	100	3,000	76	22.2	5.5
963005	Fascetta con occhiello Mounting cable ties	370x4,8	naturale natural	100	2,000	102	22.2	5.5
963006	Fascetta con occhiello Mounting cable ties	200x7,6	naturale natural	100	2,000	50	54.4	5.7
963007	Fascetta con occhiello Mounting cable ties	300x7,6	naturale natural	100	2,000	76	54.4	5.7
963008	Fascetta con occhiello Mounting cable ties	375x7,6	naturale natural	100	2,000	98	54.4	6.3

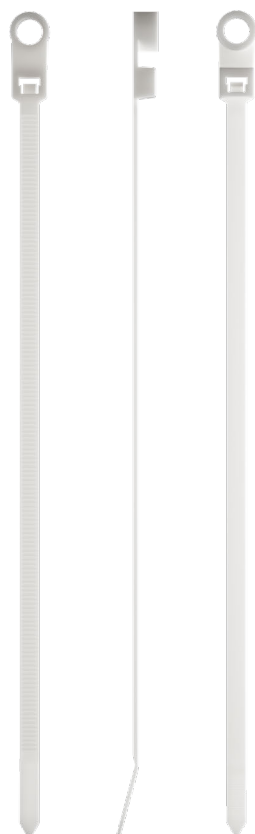

FASCETTE - CABLE TIES

Fascette ad innesto rapido

PER PANNELLO, IN PA66

Push mount cable ties

FOR PANELS, IN PA66

Fascette di cablaggio prodotte in PA6.6 colore naturale, sono suggerite per fissaggi su pannello con foro attraverso l'innesto delle stesse. Una sporgenza sulla parte bassa della fascetta la rende sempre parallela al pannello. Consigliate per quadristica, cablaggi speciali e pannelli interni di elettrodomestici (se già montata sul cablaggio riduce i tempi di assemblaggio delle apparecchiature).

Attraverso il sistema d'aggancio tra dente e cremagliera permettono il fissaggio di vari diametri.

In caso di applicazione con l'utilizzo di utensile si raccomanda la corretta regolazione di tensione dello stesso proporzionata alla dimensione della fascetta.

Wiring cable ties made of PA6.6, natural color, are suggested for fixing on panels by insertion in a hole. A protrusion on the lower part of the cable tie always sets it parallel to the panel. Ideal for switchboards, special wirings and inner panels of appliances (when already mounted on the wiring they shorten the assembly work time of devices).

The hooking system between the pawl and the rack permits the fixing of various diameters.

In case of a non-manual installation, please make sure your tool is regulated for a stress in proportion to the size of the cable tie.

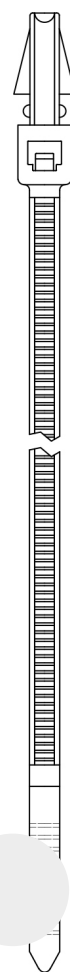

NATURALE
NATURAL



Fascette ad innesto rapido per pannello

Push mount cable ties for panles



Fascette ad innesto rapido per pannello
Push mount cable ties for panles



CONFEZIONI da
Pz. 100
BAG of 100 pcs



Imballo
Packaging

COD. ART. ITEM CODE	DESCRIZIONE DESCRIPTION	MISURA SIZE (mm)	COLORE COLOUR	PZ. PCS.	PZ. IMBALLO CARTON PCS.	MAX (mm)	MIN (Kg)	FORO HOLE (mm)	SPESSORE PANNELLO PANEL THICKNESS (mm)
963031	Fascette ad innesto rapido per pannello Push mount cable ties for panels	150x3,6	naturale natural	100	2,000	32	13.6	5	2.5
963032	Fascette ad innesto rapido per pannello Push mount cable ties for panels	200x4,8	naturale natural	100	2,000	46	22.2	6	3.5

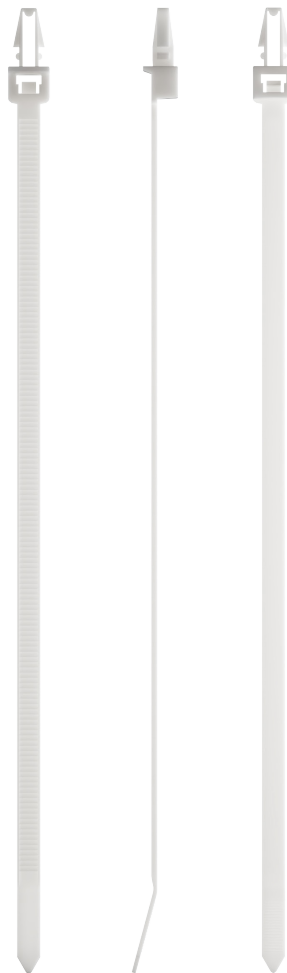

FASCETTE - CABLE TIES

Fascette ad innesto rapido

PER PANNELLO, CON FORMA A BALESTRA IN PA66

Push mount cable ties

FOR PANELS, CROSSBOW FORM IN PA66

Fascette di cablaggio prodotte in PA6.6 colore naturale, sono suggerite per fissaggi su pannello con foro attraverso l'innesto delle stesse garantendo un'applicazione stabile. Consigliate per quadristica, cablaggi speciali e pannelli interni di elettrodomestici (se già montata sul cablaggio riduce i tempi di assemblaggio delle apparecchiature).

Attraverso il sistema d'aggancio tra dente e cremagliera permettono il fissaggio di vari diametri.

In caso di applicazione con l'utilizzo di utensile si raccomanda la corretta regolazione di tensione dello stesso proporzionata alla dimensione della fascetta.

Wiring cable ties made of PA6.6, natural color, are suggested for fixing on panels by insertion in a hole thus granting a steady application. Ideal for switchboards, special wirings and inner panels of appliances (when already mounted on the wiring they shorten the assembly work time of devices).

The hooking system between the pawl and the rack permits the fixing of various diameters.

In case of a non-manual installation, please make sure your tool is regulated for a stress in proportion to the size of the cable tie.

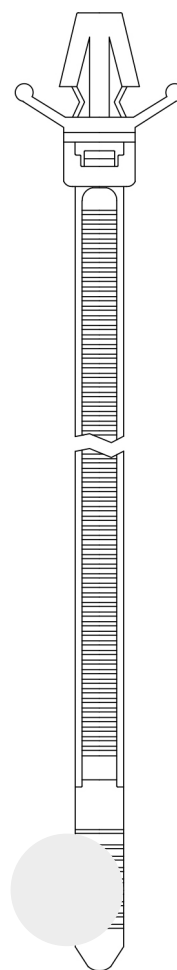

NATURALE
NATURAL



Fascette ad innesto rapido per pannello con forma a balestra

Push mount cable ties for panles crossbow form





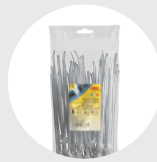

Fascette ad innesto rapido per pannello con forma a balestra
Push mount cable ties for panles crossbow form



CONFEZIONI da
Pz. 100
BAG of 100 pcs



Imballo
Packaging

COD. ART. ITEM CODE	DESCRIZIONE DESCRIPTION	MISURA SIZE (mm)	COLORE COLOUR	 PZ. PCS.	 PZ. IMBALLO CARTON PCS.	 MAX (mm)	 MIN (Kg)	 FORO HOLE (mm)	SPESSORE PANNELLO PANEL THICKNESS (mm)
963021	Fascette ad innesto rapido per pannello - con forma a balestra Push mount cable ties for panels - crossbow form	100x2,5	naturale natural	100	2,000	22	8.1	4.5	2.5
963022	Fascette ad innesto rapido per pannello - con forma a balestra Push mount cable ties for panels - crossbow form	130x3,2	naturale natural	100	2,000	28	13.6	4	2
963023	Fascette ad innesto rapido per pannello - con forma a balestra Push mount cable ties for panels - crossbow form	190x4,8	naturale natural	100	2,000	45	22.2	6	3

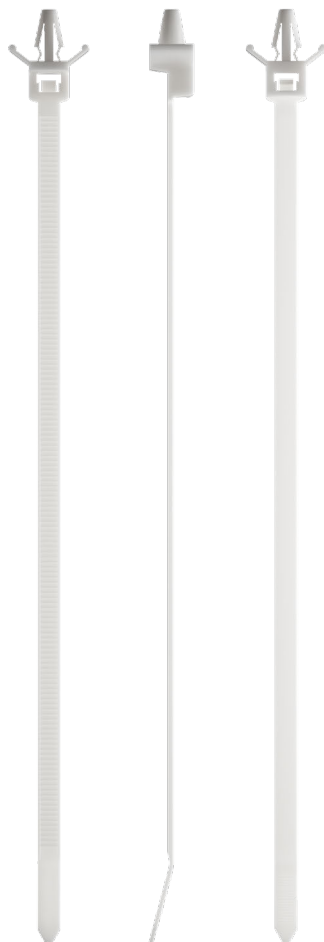

FASCETTE - CABLE TIES

Utensili per il fissaggio

PINZE PER IL SERRAGGIO FASCETTE

Fixing tools

PLIERS TO CLAMP CABLE TIES

Utensili manuali per l'installazione di fascette.

L'utilizzo di un utensile durante l'uso delle fascette velocizza l'applicazione e permette di tagliare la parte eccedente della fascetta dopo il serraggio.

I modelli disponibili permettono di installare larghezze a partire dalla 2,2 mm fino alla 10,6 mm.

Hand tools for installing cable ties.

Using a tool when fixing cable ties speeds up the application and allows to cut the excess part of the cable tie after tightening.

The available models allow the use with cable ties' widths starting from 2.2 mm up to 10.6 mm.



Utensili per il fissaggio
Fixing tools



Imballo
Packaging

COD. ART. ITEM CODE	IMMAGINE PICTURE	DESCRIZIONE DESCRIPTION	LARGHEZZA FASCETTA MIN-MAX APPLICABILE APPLICABLE MIN-MAX CABLE TIES WIDTH (mm)	COLORE COLOUR	PEZZI IMBALLO CARTON PCS.
8504		Pinza per serraggio fascette - Cable tie tool	2,2-4,8	blu - blue	10
8513		Pinza per serraggio fascette - Cable tie tool	2,2-4,8	rosso - red	10
8523		Pinza per serraggio fascette - Cable tie tool	2,2-9,5	rosso - red	10
8534		Pinza per serraggio fascette - Cable tie tool	2,5-4,8	blu - blue	10
8543		Pinza per serraggio fascette - Cable tie tool	2,2-10,6	rosso - red	10

Art. 8504

Utensile con taglio automatico per il serraggio di fascette realizzato in resina speciale caricata con fibre di vetro, parti meccaniche in acciaio. Permette di stringere e tagliare le fascette con un'unica operazione, determinando la tensione di serraggio.

Può installare fascette da 2,2 mm a 4,8 mm di larghezza.

L'utensile va regolato in proporzione alla dimensione della fascetta di cablaggio.



Taglio automatico
Automatic cutting



Automatic cutting tool to clamp cable ties, made of a special resin with fiberglass, mechanical parts in steel. It permits to clamp and cut the cable ties with one move, setting the clamping stress.

It can install cable ties from 2,2 mm to 4,8 mm width.

The tool must be set according to the size of the cable tie.

Art. 8513

Utensile con taglio automatico per il serraggio di fascette, realizzato in acciaio verniciato. Permette di stringere e tagliare le fascette con un'unica operazione, determinando la tensione di serraggio.

Può installare fascette da 2,2 mm a 4,8 mm di larghezza. L'utensile va regolato in proporzione alla dimensione della fascetta di cablaggio.



Taglio automatico
Automatic cutting



Automatic cutting tool to clamp cable ties, made of painted steel. It permits to clamp and cut the cable ties with one move, setting the clamping stress.

It can install cable ties from 2,2 mm to 4,8 mm width.

The tool must be set according to the size of the cable tie.

Art. 8523

Utensile manuale per il serraggio di fascette, ideale anche per fascette d'installazione. Realizzata in acciaio verniciato, è facile da usare ed il taglio avviene tramite l'apposita leva.

Può installare fascette fino a 9,5 mm di larghezza.



Taglio manuale con
apposita leva

Manual cutting with
specific trigger



Manual tool to clamp cable ties, ideal also for installation cable ties. Made of painted steel, it is easy to use. The cut is made by means of the specific trigger.
It can install cable ties up to 9,5 mm width.

Art. 8543

Utensile con taglio automatico per il serraggio di fascette, ideale anche per fascette d'installazione.

Realizzata in metallo, può installare fascette fino a 10,6 mm di larghezza. La forma ergonomica, evita di stressare la mano e lo rende adatto all' utilizzo prolungato. Consente di stringere e tagliare in un'unica operazione. La manopola di facile regolazione della tensione rende il taglio della fascetta più preciso.



Taglio automatico
Automatic cutting



Automatic cutting tool to clamp cable ties, ideal also for installation cable ties. **Made of painted steel, it can install cable ties up to 10,6 mm width.** The ergonomic shape avoids stressing the hand and makes it suitable for prolonged use. It permits to clamp and cut the cable ties with one move. The easy tension's control knob makes the cut of the cable ties more precise.

Art. 8534

Utensile con taglio automatico per il serraggio di fascette realizzato in plastica e metallo. La forma ergonomica, evita di stressare la mano e lo rende adatto all' utilizzo prolungato. Consente di stringere e tagliare in un'unica operazione. La manopola di facile regolazione della tensione rende il taglio della fascetta più preciso. Il tappo della manopola di regolazione accoglie un cacciavite necessario alla sostituzione della lama. La lama di ricambio è inclusa nel corpo dell' utensile. **Può installare fascette da 2,5 a 4,8 mm di larghezza.**



Taglio automatico
Automatic cutting

Automatic cutting tool to clamp cable ties, made of painted steel and plastic. The ergonomic shape avoids stressing the hand and makes it suitable for prolonged use. It permits to clamp and cut the cable ties with one move. The easy tension's control knob makes the cut of the cable ties more precise.

The cap of tension knob accommodates a screwdriver necessary to replace the blade. The spare blade is included in the tool body. **It can install cable ties from 2,5 mm to 4,8 mm width.**

SOSTITUZIONE LAMA BLADE REPLACEMENT



1. Regola la tensione a zero. Con l'aiuto di una moneta svita il tappo della manopola ed estrai il cacciavite.
1. Firstly, adjust the tension to zero. Release the cap of the tension knob with a coin. Take out the screwdriver.



2. Utilizzando l'apposito cacciavite svita la protezione della lama.
2. Unscrew the blade guard screw with the attached screwdriver.



3. Stacca la protezione ed estrai la lama usata.
3. Pull out the blade guard. Remove the used blade.



4. Rimuovi l'etichetta dal cacciavite ed estrai attentamente la nuova lama.
4. Remove the sticker on the screwdriver and take out the new blade carefully.



5. Inserisci la lama nuova. Presta attenzione che l'angolo smussato sia rivolto in alto a destra. Riponi la protezione
5. Put the new blade on the tension tool. Make sure the chamfered corner is in the upper right position. Put the blade guard back.



6. Riposiziona e avvita la vite. Non avvitare troppo stretto. Riposiziona il cacciavite nella pinza. Fine.
6. Reinstall the screw. Do not over tighten it. Put the attached screwdriver back to the tension tool. Finish.

FASCETTE - CABLE TIES

Sigilli inviolabili - tipo 1

SIGILLI IN PLASTICA CON CHIUSURA RINFORZATA IN METALLO

Plastic seal - type 1

PLASTIC SEAL WITH REINFORCED METAL CLOSURE

Pratico sigillo inviolabile e numerato progressivamente. Chiusura rinforzata con inserto in metallo per una massima sicurezza. Corpo sottile che lo rende molto versatile e applicabile da fori minimi di appena 2,5 mm.

Non riutilizzabile è ideale per sigillare contenitori dal contenuto sensibile, per identificare e riconoscere qualsiasi oggetto come trolley, estintori, porte di sicurezza, vestiario, cassette di sicurezza, kit di emergenza ecc... È adatto a molteplici utilizzi anche nei settori dei trasporti terrestri. Il fissaggio del sigillo si esegue manualmente in maniera molto facile e non è richiesto alcun utensile. Altri colori e personalizzazioni disponibili su richiesta.

Practical inviolable seal, progressively numbered. The closure is reinforced with a metal insert for maximum security. Its slim body makes it very versatile and applicable from minimum holes of just 2.5 mm.

Non-reusable, it is ideal for sealing packaging with sensitive contents, for identifying and recognizing any object such as trolley, fire extinguishers, security doors, clothing, safety boxes, emergency kits etc. It is suitable for multiple uses also in the transport sector. The sealing of the seal is done manually and very easily, no tools are required. Other colors or customizations available on request.

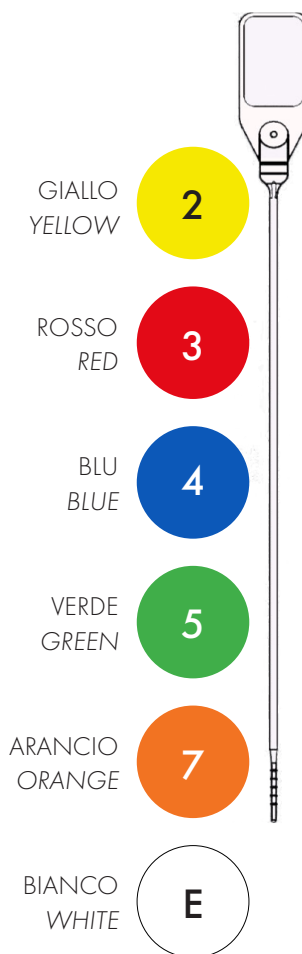

Sigilli inviolabili tipo 1 Plastic seal type 1



Sigilli inviolabili tipo 1
Plastic seal type 1



STRIP da Pz.10
STRIP of 10 pcs



Imballo
Packaging

COD. ART. ITEM CODE	DESCRIZIONE DESCRIPTION	MISURA SIZE (mm)	COLORE COLOUR	STICK PZ. STICK PCS.	PZ. IMBALLO CARTON PCS	MISURA TARGA PLATE SIZE (mm)
880E	Sigilli in plastica con chiusura rinforzata in metallo - tipo 1 <i>Reinforced metal closure plastic seals - type 1</i>	385x2.3	bianco <i>white</i>	10	1,000	22x40
8802	Sigilli in plastica con chiusura rinforzata in metallo - tipo 1 <i>Reinforced metal closure plastic seals - type 1</i>	385x2.3	giallo <i>yellow</i>	10	1,000	22x40
8803	Sigilli in plastica con chiusura rinforzata in metallo - tipo 1 <i>Reinforced metal closure plastic seals - type 1</i>	385x2.3	rosso <i>red</i>	10	1,000	22x40
8804	Sigilli in plastica con chiusura rinforzata in metallo - tipo 1 <i>Reinforced metal closure plastic seals - type 1</i>	385x2.3	blu <i>blue</i>	10	1,000	22x40
8805	Sigilli in plastica con chiusura rinforzata in metallo - tipo 1 <i>Reinforced metal closure plastic seals - type 1</i>	385x2.3	verde <i>green</i>	10	1,000	22x40
8807	Sigilli in plastica con chiusura rinforzata in metallo - tipo 1 <i>Reinforced metal closure plastic seals - type 1</i>	385x2.3	arancio <i>orange</i>	10	1,000	22x40
881E	Sigilli in plastica con chiusura rinforzata in metallo - tipo 1 <i>Reinforced metal closure plastic seals - type 1</i>	285x2.3	bianco <i>white</i>	10	1,000	22x40
8812	Sigilli in plastica con chiusura rinforzata in metallo - tipo 1 <i>Reinforced metal closure plastic seals - type 1</i>	285x2.3	giallo <i>yellow</i>	10	1,000	22x40
8813	Sigilli in plastica con chiusura rinforzata in metallo - tipo 1 <i>Reinforced metal closure plastic seals - type 1</i>	285x2.3	rosso <i>red</i>	10	1,000	22x40
8814	Sigilli in plastica con chiusura rinforzata in metallo - tipo 1 <i>Reinforced metal closure plastic seals - type 1</i>	285x2.3	blu <i>blue</i>	10	1,000	22x40
8815	Sigilli in plastica con chiusura rinforzata in metallo - tipo 1 <i>Reinforced metal closure plastic seals - type 1</i>	285x2.3	verde <i>green</i>	10	1,000	22x40
8817	Sigilli in plastica con chiusura rinforzata in metallo - tipo 1 <i>Reinforced metal closure plastic seals - type 1</i>	285x2.3	arancio <i>orange</i>	10	1,000	22x40

Stampa e personalizzazioni disponibili su richiesta. Printable customizations available on request.

Diamo la possibilità di personalizzare le targhette stampando su di esse lettere, numeri, numeri seriali, barcode e loghi in base alle esigenze del Cliente. La stampa risulta chiara e ben leggibile. Per maggiori informazioni contattare la sede.

There is the possibility to customize the plastic seal by printing letters, numbers, sequential numbers, barcode and logos on them according to the customer's needs. The print result is clear and well readable. For more information please contact us.



FASCETTE - CABLE TIES

Sigilli inviolabili - tipo 2

SIGILLI IN PLASTICA CON FISSAGGIO REGOLABILE

Plastic seal - type 2

ADJUSTABLE CLOSURE PLASTIC SEAL

Pratico sigillo inviolabile e numerato progressivamente. Il fissaggio è regolabile grazie al corpo zigrinato. Chiusura rinforzata con inserto in poliacetato per una massima sicurezza. Non riutilizzabile è ideale per sigillare sacchi e contenitori dal contenuto sensibile, per identificare e riconoscere qualsiasi oggetto come trolley, piante, estintori, porte di sicurezza, maniglie anti-panico, vestiario, ecc. Il fissaggio del sigillo si esegue manualmente in maniera molto facile e non è richiesto alcun utensile.

Altri colori e personalizzazioni disponibili su richiesta.

Practical inviolable seal, progressively numbered. The fixing is adjustable thanks to the knurled body. The closure is reinforced with a polyacetate insert for maximum security. Non-reusable, it is ideal for sealing packaging with sensitive contents, for identifying and recognizing any object such as trolley, fire extinguishers, security doors, clothing, safety boxes, emergency kits etc. The sealing of the seal is done manually and very easily, no tools are required.

Other colors or customizations available on request.

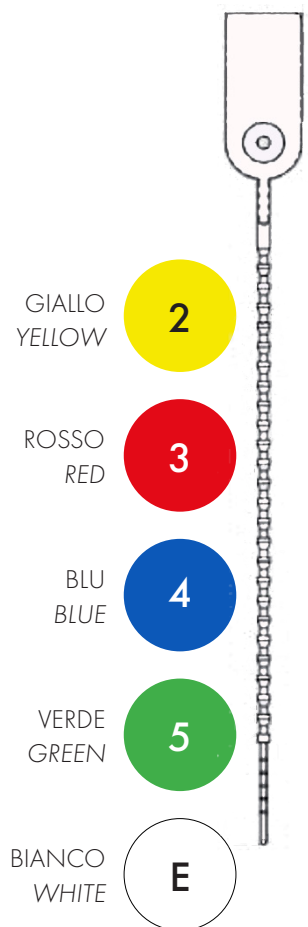

Sigilli inviolabili tipo 2 Plastic seal type 2



Sigilli inviolabili tipo2
Plastic seal type2

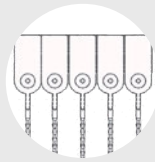

STRIP da Pz.5
STRIP of 5 pcs



Imballo
Packaging

COD. ART. ITEM CODE	DESCRIZIONE DESCRIPTION	MISURA SIZE (mm)	COLORE COLOUR	STICK PZ. STICK PCS.	PZ. IMBALLO CARTON PCS	MISURA TARGA PLATE SIZE (mm)
882E	Sigilli in plastica con fissaggio regolabile - tipo 2 <i>Adjustable closure plastic seals - type 2</i>	190x2	bianco <i>white</i>	5	1,000	15x20
8822	Sigilli in plastica con fissaggio regolabile - tipo 2 <i>Adjustable closure plastic seals - type 2</i>	190x2	giallo <i>yellow</i>	5	1,000	15x20
8823	Sigilli in plastica con fissaggio regolabile - tipo 2 <i>Adjustable closure plastic seals - type 2</i>	190x2	rosso <i>red</i>	5	1,000	15x20
8824	Sigilli in plastica con fissaggio regolabile - tipo 2 <i>Adjustable closure plastic seals - type 2</i>	190x2	blu <i>blue</i>	5	1,000	15x20
8825	Sigilli in plastica con fissaggio regolabile - tipo 2 <i>Adjustable closure plastic seals - type 2</i>	190x2	verde <i>green</i>	5	1,000	15x20

Stampa e personalizzazioni disponibili su richiesta. *Printable customizations available on request.*

Diamo la possibilità di personalizzare le targhette stampando su di esse lettere, numeri, numeri seriali, barcode e loghi in base alle esigenze del Cliente. La stampa risulta chiara e ben leggibile. Per maggiori informazioni contattare la sede.

There is the possibility to customize the plastic seal by printing letters, numbers, sequential numbers, barcode and logos on them according to the customer's needs. The print result is clear and well readable. For more information please contact us.



FASCETTE - CABLE TIES

Sigilli inviolabili - tipo 3

SIGILLI IN PLASTICA ALTA RESISTENZA

Plastic seal - type 3

HIGH RESISTANCE PLASTIC SEAL

Pratico sigillo inviolabile e numerato progressivamente. Interamente prodotto in materiale plastico, è un pezzo unico e garantisce un alta resistenza. Non riutilizzabile è ideale per sigillare contenitori dal contenuto sensibile, per identificare e riconoscere qualsiasi oggetto come trolley, estintori, porte di sicurezza, vestiario, cassette di sicurezza, kit di emergenza ecc.. E' adatto a molteplici utilizzi anche nei settori dei trasporti terrestri, ferroviari ed aerei. Il fissaggio del sigillo si esegue manualmente in maniera molto facile e non è richiesto alcun utensile.

Altri colori e personalizzazioni disponibili su richiesta.

Practical inviolable seal, progressively numbered. Entirely made of plastic material, it is a unique piece and guarantees a high resistance. Non-reusable, it is ideal for sealing containers with sensitive contents, for identifying and recognizing any object such as trolley, fire extinguishers, security doors, clothing, safety boxes, emergency kits, etc. It is suitable for multiple uses also in the terrestrial, railway and air transport sectors. The sealing of the seal is done manually and very easily, no tools are required.

Other colors or customizations available on request.



GIALLO
YELLOW

2

ROSSO
RED

3

BLU
BLUE

4

VERDE
GREEN

5

BIANCO
WHITE

E

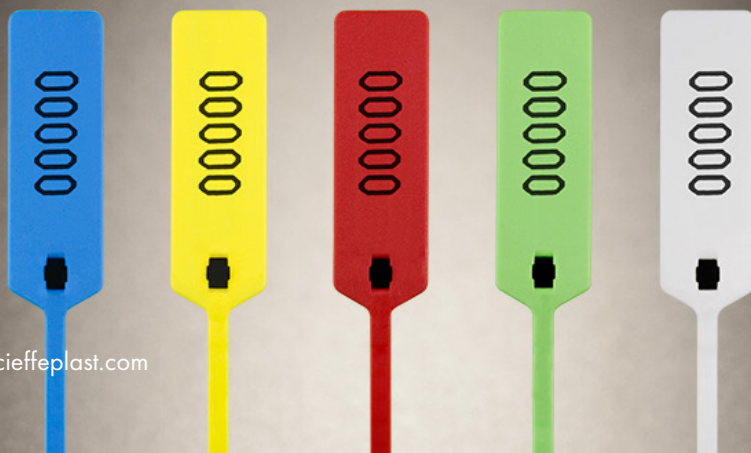
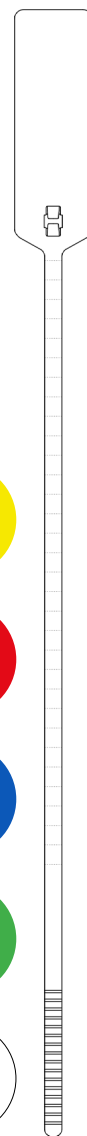

Sigilli inviolabili tipo 3 Plastic seal type 3



Sigilli inviolabili tipo 3
Plastic seal type 3



STRIP da Pz.5
STRIP of 5 pcs



Imballo
Packaging

COD. ART. ITEM CODE	DESCRIZIONE DESCRIPTION	MISURA SIZE (mm)	COLORE COLOUR	STICK PZ. STICK PCS.	PZ. IMBALLO CARTON PCS	MISURA TARGA PLATE SIZE (mm)
883E	Sigilli in plastica alta resistenza - tipo 3 High resistance plastic seals - type 3	232x3,4	bianco white	5	1,000	46x14
8832	Sigilli in plastica alta resistenza - tipo 3 High resistance plastic seals - type 3	232x3,4	giallo yellow	5	1,000	46x14
8833	Sigilli in plastica alta resistenza - tipo 3 High resistance plastic seals - type 3	232x3,4	rosso red	5	1,000	46x14
8834	Sigilli in plastica alta resistenza - tipo 3 High resistance plastic seals - type 3	232x3,4	blu blue	5	1,000	46x14
8835	Sigilli in plastica alta resistenza - tipo 3 High resistance plastic seals - type 3	232x3,4	verde green	5	1,000	46x14
884E	Sigilli in plastica alta resistenza - tipo 3 High resistance plastic seals - type 3	310x3,4	bianco white	5	1,000	46x14
8842	Sigilli in plastica alta resistenza - tipo 3 High resistance plastic seals - type 3	310x3,4	giallo yellow	5	1,000	46x14
8843	Sigilli in plastica alta resistenza - tipo 3 High resistance plastic seals - type 3	310x3,4	rosso red	5	1,000	46x14
8844	Sigilli in plastica alta resistenza - tipo 3 High resistance plastic seals - type 3	310x3,4	blu blue	5	1,000	46x14
8845	Sigilli in plastica alta resistenza - tipo 3 High resistance plastic seals - type 3	310x3,4	verde green	5	1,000	46x14

Stampa e personalizzazioni disponibili su richiesta. Printable customizations available on request.

Diamo la possibilità di personalizzare le targhette stampando su di esse lettere, numeri, numeri seriali, barcode e loghi in base alle esigenze del Cliente. La stampa risulta chiara e ben leggibile. Per maggiori informazioni contattare la sede.

There is the possibility to customize the plastic seal by printing letters, numbers, sequential numbers, barcode and logos on them according to the customer's needs. The print result is clear and well readable. For more information please contact us.



FASCETTE - CABLE TIES

Sigilli inviolabili - tipo 4

SIGILLO IN METALLO

Metal seal - type 4

STEEL METAL SEAL

Robusto sigillo inviolabile e numerato progressivamente interamente prodotto in acciaio. Risponde alla normativa ISO:17712:2013 che ne garantisce l'alta sicurezza. Sigilla facilmente containers e camions ed è ampiamente utilizzato per trasporti terrestri, ferroviari, aerei e marittimi grazie all'alta resistenza ai tentativi di manomissione.

Il fissaggio del sigillo si esegue con una leggera pressione manuale attraverso il sistema a chiodo e non richiede alcun utensile.

Sturdy, inviolable and progressively numbered seal, entirely made of steel. Complies with ISO: 17712: 2013 regulation which guarantees high security. It easily seals containers and trucks and is widely used for land, rail, air and sea transport thanks to the high resistance to tampering attempts. The sealing of the seal is carried out with a light manual pressure through the nail system and does not require any tools.

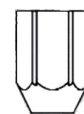

GIALLO
YELLOW





Sigilli inviolabili tipo 4 Metal seal type 4



Sigilli inviolabili tipo 4
Metal seal type 4



Imballo
Packaging

COD. ART. ITEM CODE	DESCRIZIONE DESCRIPTION	MISURA SIZE (mm)	COLORE COLOUR	PZ. IMBALLO CARTON PCS
8852	Sigilli in metallo - tipo 4 Steel metal seal - type 4	87x23	giallo yellow	250



FASCETTE - CABLE TIES

Espositore da banco

PER FASCETTE "SMART"

Counter display

FOR CABLE TIES "SMART"

SMART è il pratico espositore da banco per fascette di cablaggio Cobra. Veloce e leggero è disponibile in vari kit con assortimenti di diverse misure e colori. Viene consegnato in pochi giorni già montato e riempito. Le sue dimensioni contenute lo rendono ideale per bancone di vendita o scaffale; aperto misura L30xP40xH35 cm mentre chiuso misura L30xP40xH15 cm. Per aprirlo è sufficiente piegare a metà il coperchio e così montare il crowner e in un attimo è pronto per la vendita.



SMART is the practical counter display for Cobra cable ties. Light and easy it is available in several kits with assortments of different sizes and colors. Delivered in a few days already assembled and filled. Its restrained dimensions makes it ideal for sales' counter or shelf; open measure L30xP40xH35 cm while closed measure L30xP40xH15 cm. To open is simply bend the lid halfway to fit crowner and in a while it is ready for the sale.

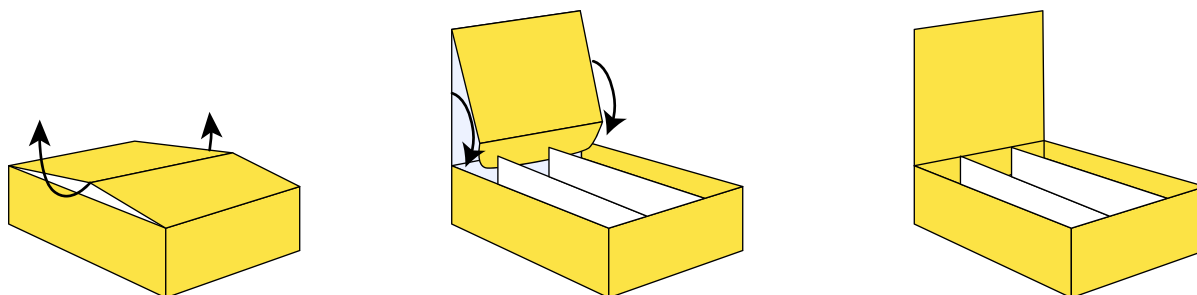

8620



Smart kit fascette 2,5
Cable ties smart kit 2,5



Naturale
Natural

COD. ART. ITEM CODE	DESCRIZIONE DESCRIPTION	MISURA SIZE (mm)	COLORE COLOUR	TOT. CONF. BAGS	PZ. PER CONF. BAG. PCS.
9050	Kit fascette - Cable ties kit	100x2,5	naturale - natural	10	1,000
9070	Kit fascette - Cable ties kit	140x2,5	naturale - natural	10	1,000
9090	Kit fascette - Cable ties kit	160x2,5	naturale - natural	18	1,800
9080	Kit fascette - Cable ties kit	200x2,5	naturale - natural	12	1,200

8622



Smart kit fascette 3,6
Cable ties smart kit 3,6

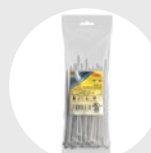

Naturale
Natural

COD. ART. ITEM CODE	DESCRIZIONE DESCRIPTION	MISURA SIZE (mm)	COLORE COLOUR	TOT. CONF. BAGS	PZ. PER CONF. BAG. PCS.
9130	Kit fascette - Cable ties kit	140x3,6	naturale - natural	20	2,000
9150	Kit fascette - Cable ties kit	200x3,6	naturale - natural	12	1,200
9160	Kit fascette - Cable ties kit	290x3,6	naturale - natural	10	1,000

8624



Smart kit fascette 4,8
Cable ties smart kit 4,8

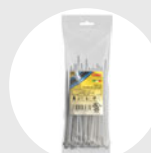

Naturale
Natural

COD. ART. ITEM CODE	DESCRIZIONE DESCRIPTION	MISURA SIZE (mm)	COLORE COLOUR	TOT. CONF. BAGS	PZ. PER CONF. BAG. PCS.
9260	Kit fascette - Cable ties kit	200x4,8	naturale - natural	10	1,000
9280	Kit fascette - Cable ties kit	290x4,8	naturale - natural	8	800
9290	Kit fascette - Cable ties kit	360x4,8	naturale - natural	6	600

8630



Smart kit fascette mix
Cable ties smart kit mix

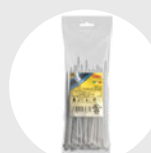

Naturale
Natural

COD. ART. ITEM CODE	DESCRIZIONE DESCRIPTION	MISURA SIZE (mm)	COLORE COLOUR	TOT. CONF. BAGS	PZ. PER CONF. BAG. PCS.
9050	Kit fascette - Cable ties kit	100x2,5	naturale - natural	10	1,000
9130	Kit fascette - Cable ties kit	140x3,6	naturale - natural	10	1,000
9260	Kit fascette - Cable ties kit	200x4,8	naturale - natural	10	1,000
9280	Kit fascette - Cable ties kit	290x4,8	naturale - natural	8	800

8632



Smart kit fascette mix
Cable ties smart kit mix

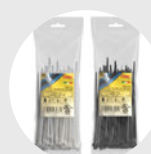

Naturale/nero
Natural/black

COD. ART. ITEM CODE	DESCRIZIONE DESCRIPTION	MISURA SIZE (mm)	COLORE COLOUR	TOT. CONF. BAGS	PZ. PER CONF. BAG. PCS.
9050	Kit fascette - Cable ties kit	100x2,5	naturale - natural	5	500
9051	Kit fascette - Cable ties kit	100x2,5	nero - black	5	500
9130	Kit fascette - Cable ties kit	140x3,6	naturale - natural	5	500
9131	Kit fascette - Cable ties kit	140x3,6	nero - black	5	500
9260	Kit fascette - Cable ties kit	200x4,8	naturale - natural	5	500
9261	Kit fascette - Cable ties kit	200x4,8	nero - black	5	500
9280	Kit fascette - Cable ties kit	290x4,8	naturale - natural	4	400
9281	Kit fascette - Cable ties kit	290x4,8	nero - black	4	400

8621



Smart kit fascette 2,5
Cable ties smart kit 2,5



Nero
Black

COD. ART. ITEM CODE	DESCRIZIONE DESCRIPTION	MISURA SIZE (mm)	COLORE COLOUR	TOT. CONF. BAGS	PZ. PER CONF. BAG. PCS.
9051	Kit fascette - Cable ties kit	100x2,5	nero - black	10	1,000
9071	Kit fascette - Cable ties kit	140x2,5	nero - black	10	1,000
9091	Kit fascette - Cable ties kit	160x2,5	nero - black	18	1,800
9081	Kit fascette - Cable ties kit	200x2,5	nero - black	12	1,200

8623



Smart kit fascette 3,6
Cable ties smart kit 3,6



Nero
Black

COD. ART. ITEM CODE	DESCRIZIONE DESCRIPTION	MISURA SIZE (mm)	COLORE COLOUR	TOT. CONF. BAGS	PZ. PER CONF. BAG. PCS.
9131	Kit fascette - Cable ties kit	140x3,6	nero - black	20	2,000
9151	Kit fascette - Cable ties kit	200x3,6	nero - black	12	1,200
9161	Kit fascette - Cable ties kit	290x3,6	nero - black	10	1,000

8625



Smart kit fascette 4,8
Cable ties smart kit 4,8



Nero
Black

COD. ART. ITEM CODE	DESCRIZIONE DESCRIPTION	MISURA SIZE (mm)	COLORE COLOUR	TOT. CONF. BAGS	PZ. PER CONF. BAG. PCS.
9261	Kit fascette - Cable ties kit	200x4,8	nero - black	10	1,000
9281	Kit fascette - Cable ties kit	290x4,8	nero - black	8	800
9291	Kit fascette - Cable ties kit	360x4,8	nero - black	6	600

8631



Smart kit fascette mix
Cable ties smart kit mix



Nero
Black

COD. ART. ITEM CODE	DESCRIZIONE DESCRIPTION	MISURA SIZE (mm)	COLORE COLOUR	TOT. CONF. BAGS	PZ. PER CONF. BAG. PCS.
9051	Kit fascette - Cable ties kit	100x2,5	nero - black	10	1,000
9131	Kit fascette - Cable ties kit	140x3,6	nero - black	10	1,000
9261	Kit fascette - Cable ties kit	200x4,8	nero - black	10	1,000
9281	Kit fascette - Cable ties kit	290x4,8	nero - black	8	800

8626



Smart kit fascette 3,6
Cable ties smart kit 3,6



Colorate
Coloured

COD. ART. ITEM CODE	DESCRIZIONE DESCRIPTION	MISURA SIZE (mm)	COLORE COLOUR	TOT. CONF. BAGS	PZ. PER CONF. BAG. PCS.
9132	Kit fascette - Cable ties kit	140x3,6	giallo - yellow	10	1,000
9133	Kit fascette - Cable ties kit	140x3,6	rosso - red	10	1,000
9134	Kit fascette - Cable ties kit	140x3,6	blu - blue	10	1,000
9135	Kit fascette - Cable ties kit	140x3,6	verde - green	10	1,000
9137	Kit fascette - Cable ties kit	140x3,6	arancio - orange	10	1,000
913A	Kit fascette - Cable ties kit	140x3,6	rosa - pink	10	1,000

8627



Smart kit fascette
Cable ties smart kit



Verdi resistenti UV
UV green resistant

COD. ART. ITEM CODE	DESCRIZIONE DESCRIPTION	MISURA SIZE (mm)	COLORE COLOUR	TOT. CONF. BAGS	PZ. PER CONF. BAG. PCS.
9130UV	Kit fascette - Cable ties kit	140x3,6	verde uv - uv green	20	2,000
9260UV	Kit fascette - Cable ties kit	200x4,8	verde uv - uv green	10	1,000
9280UV	Kit fascette - Cable ties kit	290x4,8	verde uv - uv green	8	800

8628



Smart kit fascette 2,5
Cable ties smart kit 2,5

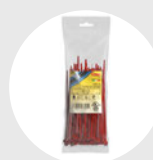

Colorate
Coloured

COD. ART. ITEM CODE	DESCRIZIONE DESCRIPTION	MISURA SIZE (mm)	COLORE COLOUR	TOT. CONF. BAGS	PZ. PER CONF. BAG. PCS.
9052	Kit fascette - Cable ties kit	100x2,5	giallo - yellow	10	1,000
9053	Kit fascette - Cable ties kit	100x2,5	rosso - red	10	1,000
9054	Kit fascette - Cable ties kit	100x2,5	blu - blue	10	1,000
9055	Kit fascette - Cable ties kit	100x2,5	verde - green	10	1,000
9057	Kit fascette - Cable ties kit	100x2,5	arancio - orange	10	1,000
905H	Kit fascette - Cable ties kit	100x2,5	grigio - gray	10	1,000

8629



Smart kit fascette mix
Cable ties smart kit mix

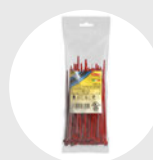

Colorate
Coloured

COD. ART. ITEM CODE	DESCRIZIONE DESCRIPTION	MISURA SIZE (mm)	COLORE COLOUR	TOT. CONF. BAGS	PZ. PER CONF. BAG. PCS.
9052	Kit fascette - Cable ties kit	100x2,5	giallo - yellow	10	1,000
9133	Kit fascette - Cable ties kit	140x3,6	rosso - red	10	1,000
9264	Kit fascette - Cable ties kit	200x4,8	blu - blue	10	1,000
9285	Kit fascette - Cable ties kit	290x4,8	verde - green	8	800

FASCETTE - CABLE TIES

Espositore da pavimento su ruote

CON CESTO CONTENITIVO E 18 GANCI PER BUSTE

Floor display with wheels

WITH METAL BASKET AND 18 HOOKS FOR BAGS

Espositore da pavimento montato su ruote con cesto contenitivo e 18 ganci per buste, completo di fascette. Molto capiente, offre un buon spazio espositivo. Viene fornito già di fascette. Nel cesto contenitivo è poi possibile alloggiare utensili e accessori a completamento della gamma di fissaggio.

Altezza 200 cm - Larghezza 60 cm.

- **Codice 8611** include espositore + kit di 18.000 pz di fascette in totale, in buste da 100 pz
- **Codice 8612** include kit di ricarica di 18.000 pz di fascette in totale, in buste da 100 pz

La selezione di seguito indicata è stata studiata per riempire tutti i 18 ganci con un assortimento che includa le misure più richieste sia in naturale che in nero:

Floor display assembled on wheels, with metal basket and 18 hooks for bags, filled of cable ties. Very roomy, it has a good display space. It is supplied with cable ties. In the containing metal basket it is then possible to place tools and accessories to complete the fixing bundling system.

Height 200 cm - Width 60 cm.

- **Code 8611** includes floor display + 18.000 pcs cable ties'kit, packaged on 100 pcs' bag.
- **Code 8612** includes 18.000 pcs cable ties' recharge kit for display, packaged on 100 pcs' bag.

The below selection has been studied to fill all 18 hooks with an assortment that includes the most requested cable ties' sizes in both natural and black:

COD. ART. ITEM CODE	DESCRIZIONE DESCRIPTION	MISURA SIZE (mm)	COLORE COLOUR	TOT. CONF. BAGS	PZ. PER CONF. BAG. PCS.
9050	Fascetta Polimmide 66 - Cable ties in PA66	100x2,5	naturale - natural	100	10
9051	Fascetta Polimmide 66 - Cable ties in PA66	100x2,5	nero black	100	10
9070	Fascetta Polimmide 66 - Cable ties in PA66	140x2,5	naturale natural	100	10
9071	Fascetta Polimmide 66 - Cable ties in PA66	140x2,5	nero black	100	10
9080	Fascetta Polimmide 66 - Cable ties in PA66	200x2,5	naturale natural	100	10
9081	Fascetta Polimmide 66 - Cable ties in PA66	200x2,5	nero black	100	10
9130	Fascetta Polimmide 66 - Cable ties in PA66	140x3,6	naturale natural	100	10
9131	Fascetta Polimmide 66 - Cable ties in PA66	140x3,6	nero black	100	10
9150	Fascetta Polimmide 66 - Cable ties in PA66	200x3,6	naturale natural	100	10
9151	Fascetta Polimmide 66 - Cable ties in PA66	200x3,6	nero black	100	10
9240	Fascetta Polimmide 66 - Cable ties in PA66	160x4,8	naturale natural	100	10
9241	Fascetta Polimmide 66 - Cable ties in PA66	160x4,8	nero black	100	10
9270	Fascetta Polimmide 66 - Cable ties in PA66	250x4,8	naturale natural	100	10
9271	Fascetta Polimmide 66 - Cable ties in PA66	250x4,8	nero black	100	10
9280	Fascetta Polimmide 66 - Cable ties in PA66	290x4,8	naturale natural	100	10
9281	Fascetta Polimmide 66 - Cable ties in PA66	290x4,8	nero black	100	10
9290	Fascetta Polimmide 66 - Cable ties in PA66	360x4,8	naturale natural	100	10
9291	Fascetta Polimmide 66 - Cable ties in PA66	360x4,8	nero black	100	10



FASCETTE - CABLE TIES

Espositore girevole da banco

SU DUE LIVELLI CON 12 GANCI PER BUSTE

Convenient revolving counter display

ON 2 LEVELS WITH 12 HOOKS FOR BAGS

Espositore da banco girevole su 2 livelli con 12 ganci per buste, completo di fascette. Ruotando permette una rapida consultazione del prodotto esposto. Viene fornito già di fascette. Le sue dimensioni contenute lo rendono ideale per i punti vendita. Altezza 80 cm.

- **Codice 8601** include espositore + kit di 6.000 pz di fascette in totale, in buste da 100 pz
- **Codice 8602** include kit di ricarica di 6.000 pz di fascette in totale, in buste da 100 pz

La selezione di seguito indicata è stata studiata per riempire tutti i 12 ganci con un assortimento che includa le misure più richieste sia in naturale che in nero:

Counter display, on 2 level revolving with 12 hooks for bags, filled of cable ties. By rotating it allows quick consultation of the displayed product. It is supplied with cable ties. Its small size makes it ideal for sale corner. Height 80 cm

- **Code 8601** includes display + 6.000 pcs cable ties'kit, packaged on 100 pcs' bag.
- **Code 8602** includes 6.000 pcs cable ties' recharge kit for display, packaged on 100 pcs' bag.

The below selection has been studied to fill all 12 hooks with an assortment that includes the most requested cable ties' sizes in both natural and black:



COD. ART. ITEM CODE	DESCRIZIONE DESCRIPTION	MISURA SIZE (mm)	COLORE COLOUR	TOT. CONF. BAGS	PZ. PER CONF. BAG. PCS.
9050	Fascetta Polimmide 66 - Cable ties in PA66	100x2,5	naturale natural	5	100
9051	Fascetta Polimmide 66 - Cable ties in PA66	100x2,5	nero black	5	100
9070	Fascetta Polimmide 66 - Cable ties in PA66	140x2,5	naturale natural	5	100
9071	Fascetta Polimmide 66 - Cable ties in PA66	140x2,5	nero black	5	100
9090	Fascetta Polimmide 66 - Cable ties in PA66	160x2,5	naturale natural	5	100
9091	Fascetta Polimmide 66 - Cable ties in PA66	160x2,5	nero black	5	100
9130	Fascetta Polimmide 66 - Cable ties in PA66	140x3,6	naturale natural	5	100
9131	Fascetta Polimmide 66 - Cable ties in PA66	140x3,6	nero black	5	100
9150	Fascetta Polimmide 66 - Cable ties in PA66	200x3,6	naturale natural	5	100
9160	Fascetta Polimmide 66 - Cable ties in PA66	290x3,6	naturale natural	5	100
9240	Fascetta Polimmide 66 - Cable ties in PA66	160x4,8	naturale natural	5	100
9271	Fascetta Polimmide 66 - Cable ties in PA66	250x4,8	nero black	5	100

Basette bidirezionali con adesivo
Self adhesive tie mount with adjustable closure

Tassello per fascette
Wall plug for cable ties

Supporto a sella con fissaggio a vite
Saddle mount with fixing screw

Supporto adesivo per cavo tondo
Self adhesive cable clamps for round cable

Spirale in polietilene
Polyethylene spiral cable wrap

Espositore da banco fascette
Counter display for cable ties

Espositore da pavimento
Floor display with wheels

Espositore girevole da banco
Convenient revolving counter display

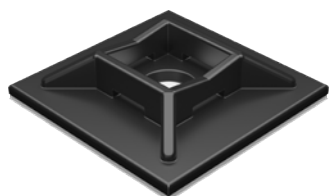

ACCESSORI *ACCESSORIES*

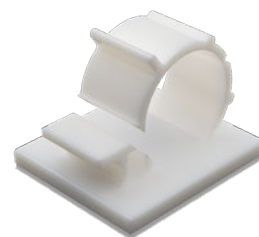
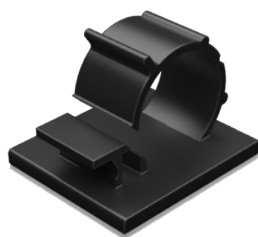
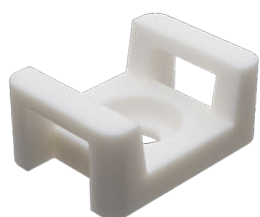

Basette bidirezionali con adesivo

Self adhesive mount tie

Accessori adesivi per fascette prodotti in PA6.6 e ABS colore naturale e nero. Suggesti per fissaggi su pannelli senza la necessità di forare. I codici 965x e 966x permettono il fissaggio anche con vite a testa svasata. Si caratterizzano per la possibilità di un fissaggio bidirezionale con fascette di cablaggio. Disponibili con adesivo standard o forte. Applicare su superfici pulite e sgrassate.

Cable ties self adhesive accessories made of PA6.6 and ABS, natural and black color. Are suggested for fixing on panels without drilling a hole. Codes 965x and 966x permit the fixing also with countersunk head screws. They are characterized by the possibility to be fixed with a bidirectional fixing with cable ties. Available with standard or strong adhesive. To be applied on clean and grease-free surfaces.

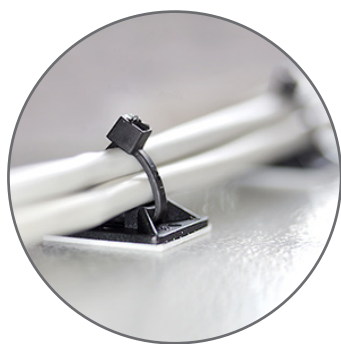

NERO
BLACK



NATURALE
NATURAL





Basette bidirezionali con adesivo Self adhesive mount tie

COD. ART. ITEM CODE	DESCRIZIONE DESCRIPTION	ADESIVO ADHESIVE	MISURA SIZE (mm)	COLORE COLOUR	A (mm)	B (mm)	C (mm)	D (mm)	∅ E (mm)	PZ. PCS.	PZ. IMBALLO CARTON PCS.
---------------------------	----------------------------	---------------------	------------------------	------------------	-----------	-----------	-----------	-----------	----------------	-------------	----------------------------

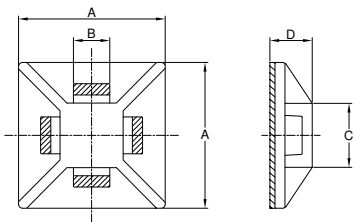

9640	Basetta in nylon Nylon self adhesive tie mount	adesivo standard standard adhesive	12x12	naturale natural	12.7	3.2	5.6	4.2	--	100	5000
9641	Basetta in nylon Nylon self adhesive tie mount	adesivo standard standard adhesive	12x12	nero black	12.7	3.2	5.6	4.2	--	100	5000

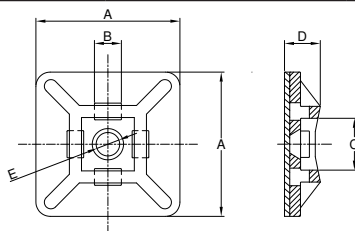

9650	Basetta in nylon Nylon self adhesive tie mount	adesivo standard standard adhesive	19x19	naturale natural	19	4	7	5	4.4	100	5000
9651	Basetta in nylon Nylon self adhesive tie mount	adesivo standard standard adhesive	19x19	nero black	19	4	7	5	4.4	100	5000
9660	Basetta in nylon Nylon self adhesive tie mount	adesivo standard standard adhesive	27x27	naturale natural	28	5.3	10.2	6.7	5.6	100	5000
9661	Basetta in nylon Nylon self adhesive tie mount	adesivo standard standard adhesive	27x27	nero black	28	5.3	10.2	6.7	5.6	100	5000

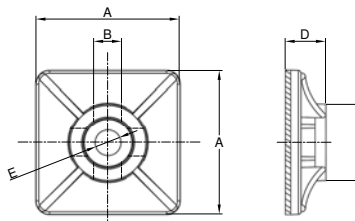

965011	Basetta in nylon Nylon self adhesive tie mount	adesivo standard base gomma standard adhesive rubber based	19x19	naturale natural	19	4.2	11	5.7	4	100	5000
965012	Basetta in nylon Nylon self adhesive tie mount	adesivo forte base acrilica strong adhesive acrylic based	19x19	naturale natural	19	4.2	11	5.7	4	100	5000
965022	Basetta in ABS ABS self adhesive tie mount	adesivo forte base acrilica strong adhesive acrylic based	19x19	naturale natural	19	4.2	11	5.7	4	100	5000
965111	Basetta in nylon Nylon self adhesive tie mount	adesivo standard base gomma standard adhesive rubber based	19x19	nero black	19	4.2	11	5.7	4	100	5000
965112	Basetta in nylon Nylon self adhesive tie mount	adesivo forte base acrilica strong adhesive acrylic based	19x19	nero black	19	4.2	11	5.7	4	100	5000
965122	Basetta in ABS ABS self adhesive tie mount	adesivo forte base acrilica strong adhesive acrylic based	19x19	nero black	19	4.2	11	5.7	4	100	5000
966011	Basetta in nylon Nylon self adhesive tie mount	adesivo standard base gomma standard adhesive rubber based	27x27	naturale natural	26.6	6.2	14	7.3	4.8	100	6000
966012	Basetta in nylon Nylon self adhesive tie mount	adesivo forte base acrilica strong adhesive acrylic based	27x27	naturale natural	26.6	6.2	14	7.3	4.8	100	6000
966022	Basetta in ABS ABS self adhesive tie mount	adesivo forte base acrilica strong adhesive acrylic based	27x27	naturale natural	26.6	6.2	14	7.3	4.8	100	6000
966111	Basetta in nylon Nylon self adhesive tie mount	adesivo standard base gomma standard adhesive rubber based	27x27	nero black	26.6	6.2	14	7.3	4.8	100	6000
966112	Basetta in nylon Nylon self adhesive tie mount	adesivo forte base acrilica strong adhesive acrylic based	27x27	nero black	26.6	6.2	14	7.3	4.8	100	6000
966122	Basetta in ABS ABS self adhesive tie mount	adesivo forte base acrilica strong adhesive acrylic based	27x27	nero black	26.6	6.2	14	7.3	4.8	100	6000

ACCESSORI - ACCESSORIES

Tassello per fascette

Wall plug for cable ties

Accessori per fascette PA6 colore nero, sono suggeriti per fissaggi, attraverso foratura, su supporti come calcestruzzo e muratura e permettono il fissaggio di tubi, fasci di cavi, canaline ed altro. Si caratterizzano per la facilità d'installazione, a battuta.

Diametro foratura 8 mm, utilizzabile con fascette di cablaggio con larghezza massima 9 mm.

Cable ties accessories in PA6, black color, are suggested for fixing, by drilling a hole, on supports like concrete and masonry, also they permit the fixing of tubes, bundle of wires, cable ducts and more. They are characterized by their easy installation with hammer-in anchor.

Hole diameter of 8 mm, cable tie maximum width of 9 mm.

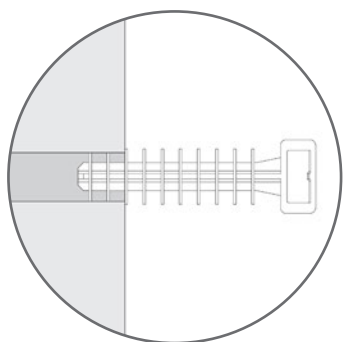

NERO
BLACK

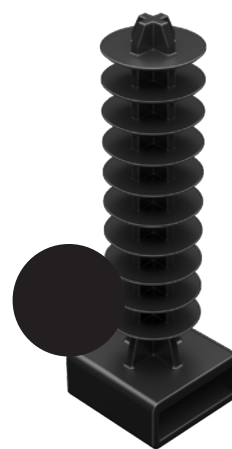



NATURALE
NATURAL

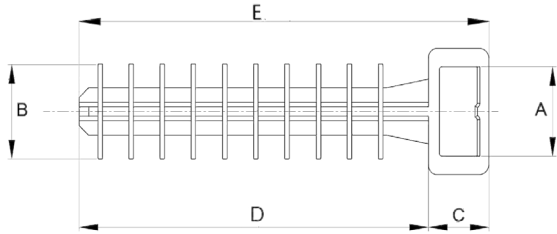

 **Tassello per fascette**
Wall plug for cable ties

COD. ART. ITEM CODE	DESCRIZIONE DESCRIPTION	COLORE COLOUR	A (mm)	B (mm)	C (mm)	D (mm)	E (mm)		PZ. PCS.	 PZ. IMBALLO CARTON PCS
---------------------------	----------------------------	------------------	-----------	-----------	-----------	-----------	-----------	---	-------------	--



9770	Tassello per fascette Wall plug for cable ties	naturale natural	9.7	10	6.4	37	43.4		100	5,000
9771	Tassello per fascette Wall plug for cable ties	nero black	9.7	10	6.4	37	43.4		100	5,000



Supporto a sella con fissaggio a vite Saddle mount with fixing screw

Accessori per fascette prodotti in PA6.6 colore naturale e nero, sono suggeriti per fissaggi su qualsiasi supporto come pannelli, pareti in muratura o apparecchiature in movimento attraverso vite o rivetto.

Si caratterizzano per la forma interna arrotondata che permette di ospitare l'elemento da fissare e per le 2 fessure per il passaggio della fascetta.

Cable ties accessories made of PA6.6, black and natural color, are suggested for fixing on any support such as panels, walls or moving devices, by means of screws or rivets.

They are characterized by their inner rounded shape which permits to host the element to be fixed, and for their 2 slots to slide the cable tie into.

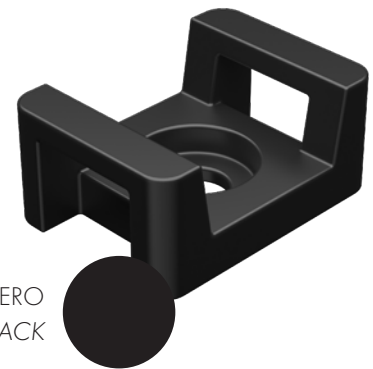

NERO
BLACK

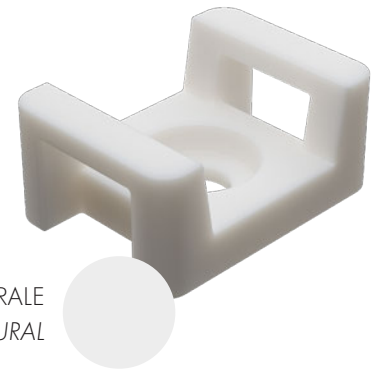

NATURALE
NATURAL





Supporto a sella con fissaggio a vite Saddle mount with fixing screw

COD. ART. ITEM CODE	DESCRIZIONE DESCRIPTION	COLORE COLOUR	A (mm)	B (mm)	C (mm)	D (mm)	E (mm)	F (mm)		PZ. PCS.	 PZ. IMBALLO CARTON PCS
---------------------------	----------------------------	------------------	-----------	-----------	-----------	-----------	-----------	-----------	--	-------------	-------------------------------

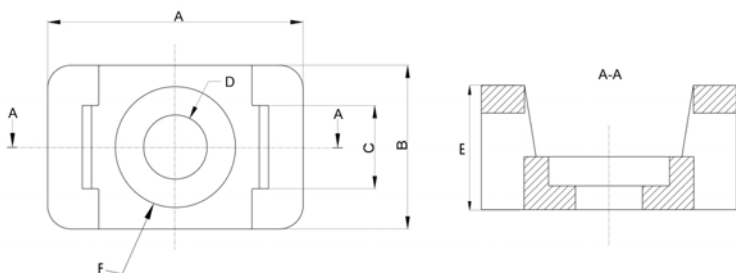

9700	Supporto a sella con fissaggio a vite Saddle mount with fixing screw	naturale natural	14.9	9.5	4.8	3.7	7.2	7		100	5,000
9701	Supporto a sella con fissaggio a vite Saddle mount with fixing screw	nero black	14.9	9.5	4.8	3.7	7.2	7		100	5,000
9710	Supporto a sella con fissaggio a vite Saddle mount with fixing screw	naturale natural	21.9	15.9	9	5	9.7	9.6		100	5,000
9711	Supporto a sella con fissaggio a vite Saddle mount with fixing screw	nero black	21.9	15.9	9	5	9.7	9.6		100	5,000



Supporto adesivo per cavo tondo

Self adhesive cable clamps for round cable

Accessori adesivi per fascette prodotti in PA6.6 colore naturale e nero, sono suggeriti per fissaggi su pannelli senza la necessità di forare. Si caratterizzano per la forma tonda creata per fissare cavi e tubi tramite il sistema di aggancio ad incastro pratico e veloce, il quale una volta chiuso può essere riaperto e richiuso tramite la levetta esterna. Applicare su superfici pulite e sgrassate.

Codici 9750-9751 per diametri (10/11) mm, codici 9760-9761 per diametri (8/9) mm.

Cable ties self adhesive accessories made of PA6.6, natural and black color, are suggested for fixing on panels without resorting to a hole. They are characterized by their round shape designed to easily and rapidly fix wirings and tubes thanks to their snap-fit hooking system. Once closed, this can be released and closed again with the outer trigger release mechanism. To be applied on clean and grease-free surfaces.

Codes 9750-9751 for diameters of (10/11) mm, codes 9760-9761 for diameters of (8/9) mm.

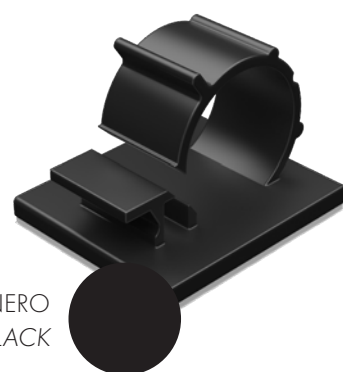
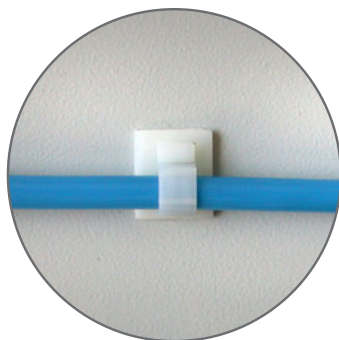

NERO
BLACK

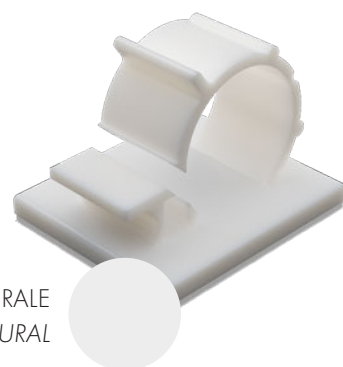

NATURALE
NATURAL





Supporto adesivo per cavo tondo

Self adhesive cable clamps for round cable

COD. ART. ITEM CODE	DESCRIZIONE DESCRIPTION	COLORE COLOUR	A (mm)	B (mm)	C Ø DIAM. D'USO DIAM. WIRE MIN-MAX (mm)	D (mm)	PZ. PCS.	PZ. IMBALLO CARTON PCS
---------------------------	----------------------------	------------------	-----------	-----------	--	-----------	-------------	---------------------------

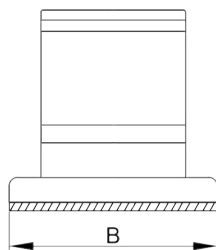
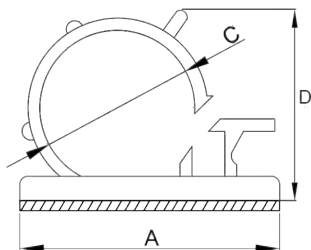

9750	Supporto adesivo per cavo tondo Self adhesive cable clamps for round cables	naturale natural	21.5	17	10-11	15	100	5000
9751	Supporto adesivo per cavo tondo Self adhesive cable clamps for round cables	nero black	21.5	17	10-11	15	100	5000
9760	Supporto adesivo per cavo tondo Self adhesive cable clamps for round cables	naturale natural	21.5	18.2	8-9	12.3	100	5000
9761	Supporto adesivo per cavo tondo Self adhesive cable clamps for round cables	nero black	21.5	18.2	8-9	12.3	100	5000



Spirale in polietilene

Polyethylene spiral cable wrap

Spirale in polietilene colore naturale e nero. Molto flessibili, sono suggerite per la protezione ed il raggruppamento di cavi e tubi permettendo la fasciatura con il cablaggio eseguito e la derivazione di cavi in qualsiasi punto. Temperatura massima di utilizzo 85 °C. I diametri di uso consigliati sono esposti nella tabella.

Polyethylene Spiral Cable Wrap in natural or black color. Highly flexible, suggested for the protection and bundle of cables and tubes, it allows to bundle after the wiring has been already done and to reroute the cables at any point. Maximum temperature of use, 85°C. The recommended diameters of use are indicated in the table below.



NATURALE
NATURAL



NERO
BLACK

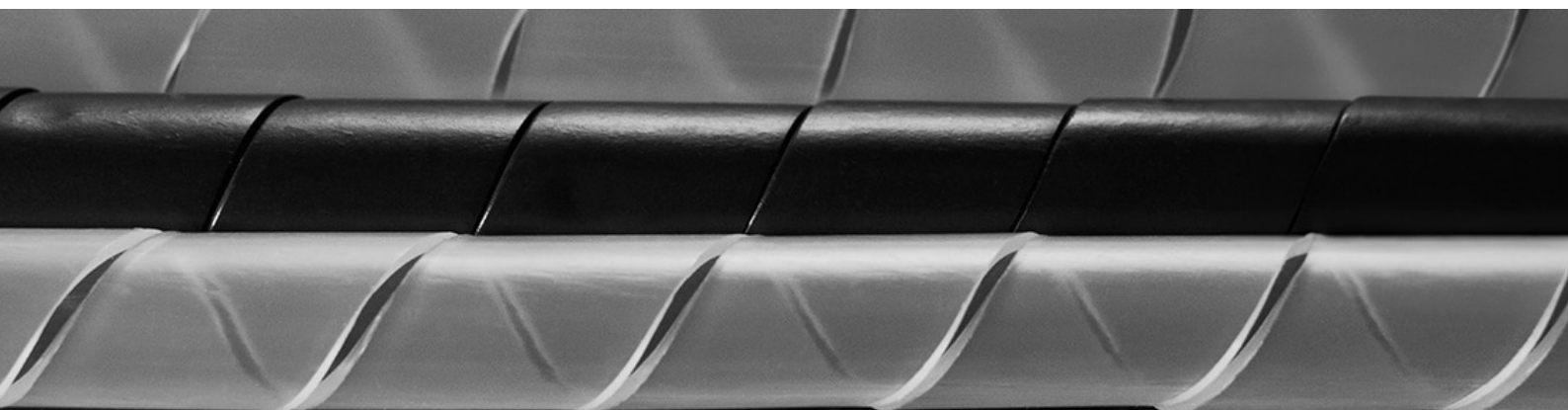

Spirale in polietilene Polyethylene spiral cable wrap

COD. ART. ITEM CODE	DESCRIZIONE DESCRIPTION	MISURA SIZE (mm)	COLORE COLOUR	CONF BAG mt.	mt. IMBALLO CARTON mt.	DIAM. D'USO DIAM. WIRE MIN-MAX (mm)
------------------------	----------------------------	---------------------	------------------	--------------------	---------------------------	---



990001	Spirale in polietilene Polyethylene spiral cable wrap	CF4	naturale natural	25	1,250	4-8
990003	Spirale in polietilene Polyethylene spiral cable wrap	CF6	naturale natural	25	625	5-12
990007	Spirale in polietilene Polyethylene spiral cable wrap	CF9	naturale natural	25	300	8-16
990009	Spirale in polietilene Polyethylene spiral cable wrap	CF12	naturale natural	25	250	10-20
990011	Spirale in polietilene Polyethylene spiral cable wrap	CF15	naturale natural	25	200	12-24
990013	Spirale in polietilene Polyethylene spiral cable wrap	CF20	naturale natural	20	80	14-30
990102	Spirale in polietilene Polyethylene spiral cable wrap	CF4N	nero black	25	1,250	4-8
990104	Spirale in polietilene Polyethylene spiral cable wrap	CF6N	nero black	25	625	5-12
990108	Spirale in polietilene Polyethylene spiral cable wrap	CF9N	nero black	25	300	8-16
990110	Spirale in polietilene Polyethylene spiral cable wrap	CF12N	nero black	25	250	10-20
990112	Spirale in polietilene Polyethylene spiral cable wrap	CF15N	nero black	25	200	12-24
990114	Spirale in polietilene Polyethylene spiral cable wrap	CF20N	nero black	20	80	14-30



Tasselli TX senza collarino
Wall plugs TX without collar

Tasselli con collarino
Wall plugs with collar

Tasselli TX senza collarino con vite
Wall plugs TX without collar with screw

Tasselli con collarino con vite
Wall plugs with collar with screw

Tasselli a battuta testa bombata
Wall plugs hammer convex head

Tasselli a battuta testa piana
Wall plugs hammer flat head

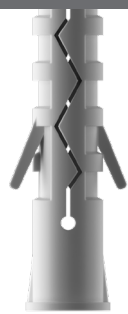
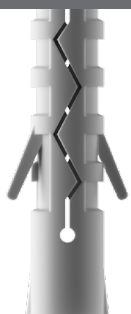

TASSELLI *WALL PLUGS*



Caratteristiche tecniche

Technical features

Grazie alla nostra pluridecennale esperienza, siamo specializzati nella produzione e fornitura di soluzioni di fissaggio universali. La nostra gamma comprende anche tasselli universali in plastica TX e tasselli a battuta. Produciamo i tasselli universali TX utilizzando esclusivamente nylon PA6 di prima scelta.

La Poliammide PA6, è uno dei polimeri termoplastici più usati per applicazioni di carattere meccanico infatti garantisce ai nostri tasselli TX un'elevata resistenza all'urto, rendendoli più tenaci e adatti ad applicazioni su calcestruzzo, mattone pieno e mattone forato nelle più svariate condizioni ambientali.

Thanks to our decades of experience, we are specialized in the production and supply of universal fastening solutions suitable for a wide range of applications. Our range also includes universal TX plastic and hammer wall plugs.

We produce TX universal plugs using only first choice PA6 nylon. Polyamide PA6 is one of the most used thermoplastic polymers for mechanical applications, in fact it guarantees our TX wall plugs an high impact strength resistance, making them more tenacious and suitable for applications on concrete, solid brick and hollow brick in the most varied environmental conditions.

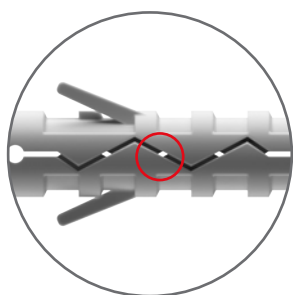

Sezione interna con guida per la vite fino al completo inserimento.

Inner section with the guide for the screw to the complete insertion.

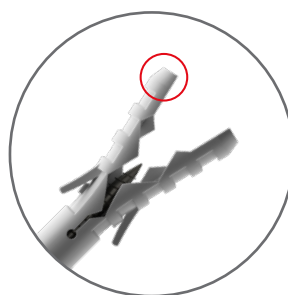

Espansione maggiorata per migliorare la tenuta.

Increased expansion to improve the seal.

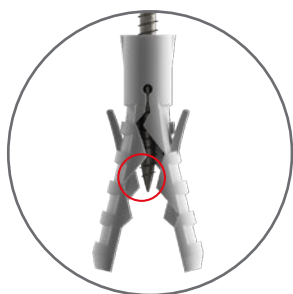

Meno punti di attrito per facilitare l'inserimento della vite.

Less friction points to facilitate the fitting of the screw.

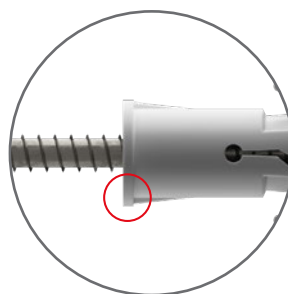

Disponibili con collarino per un corretto inserimento.

Available with collar for a correct insertion.

Oltre ad un attenta selezione della materia prima, abbiamo studiato attentamente le funzionalità del tassello, riprogettandolo. Un classico del fissaggio, qui da noi si è riscoperto e modernizzato con alette anti rotazione, guida interna per la vite, spessori irrobustiti e molto altro come meglio indicato nelle immagini sottostanti. Produciamo diametri di diverse misure sia senza collarino che con collarino, confezionandoli in varie soluzioni a scelta tra senza vite o con la vite. Produzioni e confezionamenti diversi, disponibili su richiesta.

In addition to a careful selection of the raw material, we carefully studied the functionality of the wall plug, redesigning it. A fastening classic, here it has been rediscovered and modernized with antispin fins, inner guide for the screw, strengthened thicknesses and much more as better indicated in the images below. We produce diameters of different sizes both without collar and with collar, packaging them in various solutions to choose between with or without screw. Different productions and packaging, available on request.

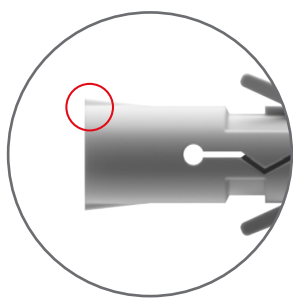

Alette antirotazione per garantire la tenuta su diverse superfici.

Antispin fins to guarantee the hold on various surfaces.

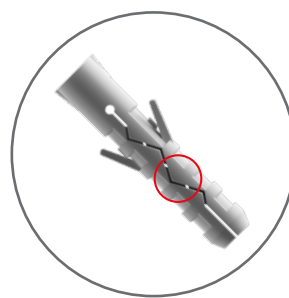

Nuovo profilo del taglio che impedisce l'inserimento di traverso della vite.

New cut profile that prevents the crooked fitting of the screw.

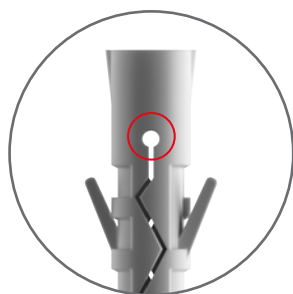

Zona di apertura predefinita per evitare rotture.

Open zone predefined to avoid breaks.

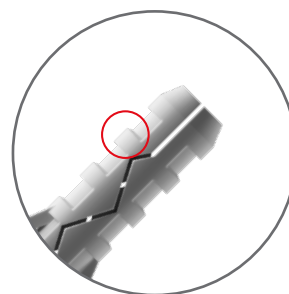

Più materiale e minori spazi vuoti per una maggiore tenuta.

More material and less empty spaces for a great seal.

Tasselli tenax senza collarino Wall plugs tenax without collar

Imballo industriale
Industrial packaging



Imballo
Packaging

COD. ART. ITEM CODE	DESCRIZIONE DESCRIPTION	MISURA TASSELLO SIZE (mm)	PZ. PCS.	PZ. IMBALLO CARTON PCS.
750001	Tassello PA6 TX-I Wall plug PA6 TX-I	5x25	-	60,000
750002	Tassello PA6 TX-I Wall plug PA6 TX-I	6x30	-	38,000
750004	Tassello PA6 TX-I Wall plug PA6 TX-I	8x40	-	17,000
750005	Tassello PA6 TX-I Wall plug PA6 TX-I	10x50	-	8,000

Imballo economico
Saving packaging



Imballo
Packaging

COD. ART. ITEM CODE	DESCRIZIONE DESCRIPTION	MISURA TASSELLO SIZE (mm)	PZ. BUSTA BAG PCS.	PZ. IMBALLO CARTON PCS.
750101	Tassello PA6 TX-E Wall plug PA6 TX-E	5x25	1,000	60,000
750102	Tassello PA6 TX-E Wall plug PA6 TX-E	6x30	1,000	35,000
750104	Tassello PA6 TX-E Wall plug PA6 TX-E	8x40	1,000	15,000
750105	Tassello PA6 TX-E Wall plug PA6 TX-E	10x50	500	6,000

Scatola
Box

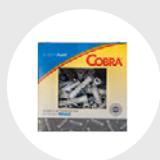

Imballo
Packaging

COD. ART. ITEM CODE	DESCRIZIONE DESCRIPTION	MISURA TASSELLO SIZE (mm)	PZ. SCATOLA BOX PCS.	PZ. IMBALLO CARTON PCS.
750201	Tassello PA6 TX-S Wall plug PA6 TX-S	5x25	200	10,000
750202	Tassello PA6 TX-S Wall plug PA6 TX-S	6x30	200	10,000
750204	Tassello PA6 TX-S Wall plug PA6 TX-S	8x40	100	5,000
750205	Tassello PA6 TX-S Wall plug PA6 TX-S	10x50	50	2,500

Tasselli tenax senza collarino con vite Wall plugs tenax without collar with screw

Scatola
Box

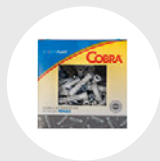
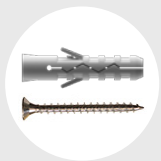

Imballo
Packaging

COD. ART. ITEM CODE	DESCRIZIONE DESCRIPTION	MISURA TASSELLO SIZE (mm)	MISURA VITE SCREW SIZE (mm)	PZ. SCATOLA BOX PCS.	PZ. IMBALLO CARTON PCS.
750301	Tassello PA6 TXVSP-S Wall plug PA6TXVSP-S	5x25	4,0x30	100	5,000
750302	Tassello PA6 TXVSP-S Wall plug PA6TXVSP-S	6x30	4,5x40	100	5,000
750304	Tassello PA6 TXVSP-S Wall plug PA6TXVSP-S	8x40	5,0x50	50	2,500
750305	Tassello PA6 TXVSP-S Wall plug PA6TXVSP-S	10x50	6,0x60	25	1,250

Tasselli tenax con collarino Wall plugs tenax with collar

Imballo industriale
Industrial packaging



Imballo
Packaging

COD. ART. ITEM CODE	DESCRIZIONE DESCRIPTION	MISURA TASSELLO SIZE (mm)	PZ. PCS.	PZ. IMBALLO CARTON PCS.
750011	Tassello PA6 TXB-I Wall plug PA6 TXB-I	5x25	-	60,000
750012	Tassello PA6 TXB-I Wall plug PA6 TXB-I	6x30	-	32,000
750014	Tassello PA6 TXB-I Wall plug PA6 TXB-I	8x40	-	15,000
750015	Tassello PA6 TXB-I Wall plug PA6 TXB-I	10x50	-	8,000

Imballo economico
Saving packaging

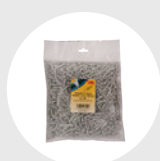

Imballo
Packaging

COD. ART. ITEM CODE	DESCRIZIONE DESCRIPTION	MISURA TASSELLO SIZE (mm)	PZ. BUSTA BAG PCS.	PZ. IMBALLO CARTON PCS.
750111	Tassello PA6 TXB-E Wall plug PA6 TXB-E	5x25	1,000	60,000
750112	Tassello PA6 TXB-E Wall plug PA6 TXB-E	6x30	1,000	30,000
750114	Tassello PA6 TXB-E Wall plug PA6 TXB-E	8x40	1,000	14,000
750115	Tassello PA6 TXB-E Wall plug PA6 TXB-E	10x50	500	6,000

Scatola
Box

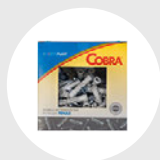

Imballo
Packaging

COD. ART. ITEM CODE	DESCRIZIONE DESCRIPTION	MISURA TASSELLO SIZE (mm)	PZ. SCATOLA BOX PCS.	PZ. IMBALLO CARTON PCS.
750211	Tassello PA6 TXB-S Wall plug PA6 TXB-S	5x25	200	10,000
750212	Tassello PA6 TXB-S Wall plug PA6 TXB-S	6x30	200	10,000
750214	Tassello PA6 TXB-S Wall plug PA6 TXB-S	8x40	100	5,000
750215	Tassello PA6 TXB-S Wall plug PA6 TXB-S	10x50	50	2,500

Tasselli tenax con collarino con vite Wall plugs tenax with collar with screw

Scatola
Box

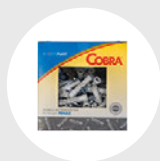
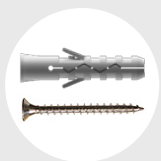

Imballo
Packaging

COD. ART. ITEM CODE	DESCRIZIONE DESCRIPTION	MISURA TASSELLO SIZE (mm)	MISURA VITE SCREW SIZE (mm)	PZ. SCATOLA BOX PCS.	PZ. IMBALLO CARTON PCS.
750311	Tassello PA6 TXBVSP-S Wall plug PA6TXBVSP-S	5x25	4,0x30	100	5,000
750312	Tassello PA6 TXBVSP-S Wall plug PA6TXBVSP-S	6x30	4,5x40	100	5,000
750314	Tassello PA6 TXBVSP-S Wall plug PA6TXBVSP-S	8x40	5,0x50	50	2,500
750315	Tassello PA6 TXBVSP-S Wall plug PA6TXBVSP-S	10x50	6,0x60	25	1,250

Utilizzo del prodotto

Using instructions

Applicazione su: pietra naturale, calcestruzzo armato, calcestruzzo, mattone forato, blocchi forati, blocco laterizio, calcestruzzo cellulare.
Espansione maggiorata. Guida interna per un facile inserimento della vite.

Application on: natural stone, reinforced concrete, concrete, solid brick, air brick, concrete air bricks, brick blocks, cellular concrete.
Increased expansion. Internal guide for easy insertion of screws.

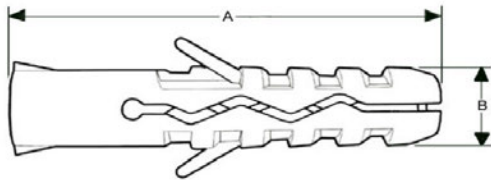

A	B	PROFONDITÀ MIN. FORATURA MIN. DRILLING DEPTH (mm)	DIAMETRO VITE SCREW DIAMETER (mm)	LUNGHEZZA MIN. VITE MIN. SCREW LENGTH (mm)
25	5	35	2,5-4	30
30	6	40	3,5-5	35
40	8	55	4,5-6	50
50	10	65	6-8	60

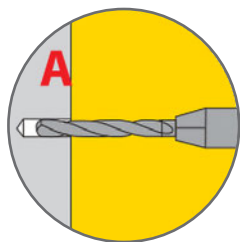

1. Praticare un foro idoneo alle dimensioni del tassello

1. Drill a hole suitable for the wall plug size

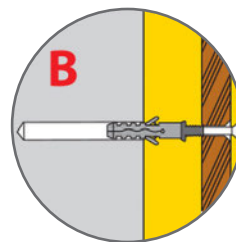

2. Inserire totalmente il tassello nel foro appena eseguito

2. Fully insert the wall plug inside the hole

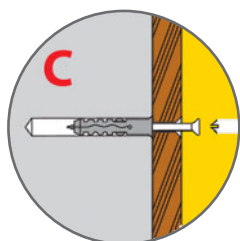

3. Inserire la vite nel tassello

3. Place the screw into the wall plug

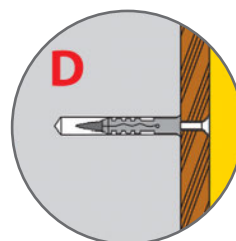

4. Avvitare la vite per un perfetto ancoraggio del tassello

4. Tighten the screw to get a perfect anchoring of the wall plug

TASSELLI - WALL PLUGS

Tasselli a battuta

Wall plugs

I tasselli a battuta anche conosciuti come tasselli a percussione e sono ideali in lattoneria. Perfetti per il fissaggio di elementi in lamiera sagomata e pressopiegata come scossaline, profili, giunti, scossaline sottotegola e soprategole, colmi in lamiera, bandinelle. Sono anche impiegati per i fissaggi di sistemi di rivestimento come facciate e pannelli e per le più classiche grondaie e canalizzazioni.

Vengono forniti con vite pre-montata in diverse soluzioni di confezionamento.

Sempre disponibili le misure 6x40, 6x50, 6x60 con testa piana o testa bombata e vite zincata.

Proponiamo anche il colore nero e marrone con vite zincata nera o in rame.

Hammer wall plugs are also known as percussion plugs and are ideal for tinsmithery world. Perfect for fixing shaped and press-formed sheet metal elements such as flashings, profiles, joints, under-tile flashings, sheet metal ridges, channel plashing. They are also used for fixing cladding systems such as facades and panels and for the more classic gutters and ducts.

They are supplied with pre-assembled screw in different packaging solutions.

Always available in sizes 6x40, 6x50, 6x60 with flat head or convex head and galvanized screw.

We also offer black and brown with black or copper galvanized screw.

Tasselli a battuta a testa bombata Hammer wall plug convex head



Tasselli a battuta a testa piana Hammer wall plug flat head

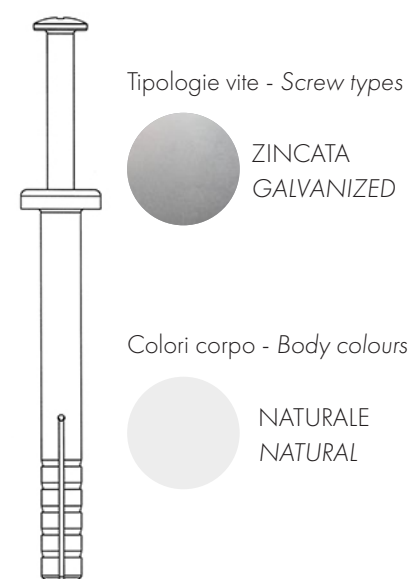



Tasselli a battuta testa bombata naturale vite zincata Wall plugs hammer convex head natural, galvanized screw



ZINCATA
GALVANIZED



NATURALE
NATURAL

COD. ART. ITEM CODE	DESCRIZIONE DESCRIPTION	COLORE COLOUR	MISURA SIZE (mm)	TIPO CONF. PACKAGING	PZ. CONF. PACK PCS.
Imballo industriale Industrial packaging					Imballo Packaging
755025	TASSELLO A BATTUTA CON VITE T.B. HAMMER WALL PLUG WITH SCREW T.B.	naturale zincata bianca natural zinc plated white	6x40	Imballo industriale Industrial pack	5,000
755026	TASSELLO A BATTUTA CON VITE T.B. HAMMER WALL PLUG WITH SCREW T.B.	naturale zincata bianca natural zinc plated white	6x50	Imballo industriale Industrial pack	4,000
755027	TASSELLO A BATTUTA CON VITE T.B. HAMMER WALL PLUG WITH SCREW T.B.	naturale zincata bianca natural zinc plated white	6x60	Imballo industriale Industrial pack	3,000
Sacchetto Bag					Imballo Packaging
755019	TASSELLO A BATTUTA CON VITE T.B. HAMMER WALL PLUG WITH SCREW T.B.	naturale zincata bianca natural zinc plated white	6x40	Sacchetto Bag	200
755020	TASSELLO A BATTUTA CON VITE T.B. HAMMER WALL PLUG WITH SCREW T.B.	naturale zincata bianca natural zinc plated white	6x50	Sacchetto Bag	200
755021	TASSELLO A BATTUTA CON VITE T.B. HAMMER WALL PLUG WITH SCREW T.B.	naturale zincata bianca natural zinc plated white	6x60	Sacchetto Bag	200
Scatola Box					Imballo Packaging
755022	TASSELLO A BATTUTA CON VITE T.B. HAMMER WALL PLUG WITH SCREW T.B.	naturale zincata bianca natural zinc plated white	6x40	Scatola Box	200
755023	TASSELLO A BATTUTA CON VITE T.B. HAMMER WALL PLUG WITH SCREW T.B.	naturale zincata bianca natural zinc plated white	6x50	Scatola Box	200
755024	TASSELLO A BATTUTA CON VITE T.B. HAMMER WALL PLUG WITH SCREW T.B.	naturale zincata bianca natural zinc plated white	6x60	Scatola Box	100









Tasselli a battuta testa bombata marrone vite nera Wall plugs hammer convex head brown, black screw



COD. ART. ITEM CODE	DESCRIZIONE DESCRIPTION	COLORE COLOUR	MISURA SIZE (mm)	TIPO CONF. PACKAGING	PZ. CONF. PACK PCS.
Imballo industriale Industrial packaging					Imballo Packaging
755043	TASSELLO A BATTUTA CON VITE T.B. HAMMER WALL PLUG WITH SCREW T.B.	marrone RAL8017 zincata nera brown RAL8017 zinc plated black	6x40	Imballo industriale Industrial pack	5,000
Sacchetto Bag					Imballo Packaging
755037	TASSELLO A BATTUTA CON VITE T.B. HAMMER WALL PLUG WITH SCREW T.B.	marrone RAL8017 zincata nera brown RAL8017 zinc plated black	6x40	Sacchetto Bag	200
Scatola Box					Imballo Packaging
755040	TASSELLO A BATTUTA CON VITE T.B. HAMMER WALL PLUG WITH SCREW T.B.	marrone RAL8017 zincata nera brown RAL8017 zinc plated black	6x40	Scatola Box	200

Tasselli a battuta testa bombata nera vite nera Wall plugs hammer convex head brown, copper screw



COD. ART. ITEM CODE	DESCRIZIONE DESCRIPTION	COLORE COLOUR	MISURA SIZE (mm)	TIPO CONF. PACKAGING	PZ. CONF. PACK PCS.
Imballo industriale Industrial packaging					Imballo Packaging
755052	TASSELLO A BATTUTA CON VITE T.B. HAMMER WALL PLUG WITH SCREW T.B.	nero zincata nera black zinc plated black	6x40	Imballo industriale Industrial pack	5,000
Sacchetto Bag					Imballo Packaging
755046	TASSELLO A BATTUTA CON VITE T.B. HAMMER WALL PLUG WITH SCREW T.B.	nero zincata nera black zinc plated black	6x40	Sacchetto Bag	200
Scatola Box					Imballo Packaging
755049	TASSELLO A BATTUTA CON VITE T.B. HAMMER WALL PLUG WITH SCREW T.B.	nero zincata nera black zinc plated black	6x40	Scatola Box	200

Tasselli a battuta testa bombata marrone vite in rame **Wall plugs hammer convex head brown, copper screw**



RAME
COPPER



MARRONE
BROWN

COD. ART. ITEM CODE	DESCRIZIONE DESCRIPTION	COLORE COLOUR	MISURA SIZE (mm)	TIPO CONF. PACKAGING	PZ. CONF. PACK PCS.
	Imballo industriale Industrial packaging				Imballo Packaging
755061	TASSELLO A BATTUTA CON VITE T.B. HAMMER WALL PLUG WITH SCREW T.B.	marrone RAL8017 rame marrone RAL8017 rame	6x40	Imballo industriale Industrial pack	5,000
	Sacchetto Bag				Imballo Packaging
755055	TASSELLO A BATTUTA CON VITE T.B. HAMMER WALL PLUG WITH SCREW T.B.	marrone RAL8017 rame marrone RAL8017 rame	6x40	Sacchetto Bag	200
	Scatola Box				Imballo Packaging
755058	TASSELLO A BATTUTA CON VITE T.B. HAMMER WALL PLUG WITH SCREW T.B.	marrone RAL8017 rame marrone RAL8017 rame	6x40	Scatola Box	200

Tasselli a battuta testa piana naturale vite zincata **Wall plugs hammer flat head natural, galvanized screw**



ZINCATA
GALVANIZED



NATURALE
NATURAL

COD. ART. ITEM CODE	DESCRIZIONE DESCRIPTION	COLORE COLOUR	MISURA SIZE (mm)	TIPO CONF. PACKAGING	PZ. CONF. PACK PCS.
	Imballo industriale Industrial packaging				Imballo Packaging
755016	TASSELLO A BATTUTA CON VITE T.P. HAMMER WALL PLUG WITH SCREW T.P.	naturale zincata bianca natural zinc plated white	6x40	Imballo industriale Industrial pack	5,000
	Sacchetto Bag				Imballo Packaging
755010	TASSELLO A BATTUTA CON VITE T.P. HAMMER WALL PLUG WITH SCREW T.P.	naturale zincata bianca natural zinc plated white	6x40	Sacchetto Bag	200
	Scatola Box				Imballo Packaging
755013	TASSELLO A BATTUTA CON VITE T.P. HAMMER WALL PLUG WITH SCREW T.P.	naturale zincata bianca natural zinc plated white	6x40	Scatola Box	200

CIEFFEPLAST s.r.l.

COBRA[®]
CABLE TIES
MADE IN ITALY



Via Villa Albarella 2 - 35020
Maserà di Padova (PD) - Italy



+39 049 8863907
+39 049 8863900



info@cieffeplast.com



www.cieffeplast.com