

dnd



24-
25

Un catalogo che racconta
Dnd e presenta le sue
collezioni di maniglie,
realizzate con esperienza
e passione in nome
del miglior design e
del fatto bene.

*A catalogue that narrates
the story of Dnd whilst
presenting the company's
handle collections; each
created with expertise and
passion in the name of top
design and high quality.*

dnd

**handles
with care**





































**24-
25**













Maniglie che sono frutto di **cura, attenzione, passione.** Dnd mette la sua sapienza produttiva al servizio della migliore creatività, coinvolgendo nello sviluppo delle collezioni **progettisti di valore** per focalizzare l'attenzione verso il mondo del design, arricchire la gamma dei prodotti e soddisfare al meglio la progettazione degli interni contemporanei.

*Handles that are the result of **care, attention and passion.** Dnd puts its manufacturing expertise at the service of the most brilliant creativity, collaborating with **outstanding designers** to develop collections that shine a light on the world of design, enrich its range of products and fully satisfy the needs of contemporary interior design.*











indice / index

maniglie Alta gamma
High-end door handles

anik		079	blend 02		174	DUE		157
anik 02		082	blip		226	dune		098
anik brilliant		084	boole		147	edra 02		194
anik brilliant 02		086	C-1918		190	elena		243
anik line		088	change B 02		208	eleonora		130
anik line 02		090	cloe		210	eleonora 02		132
aretè		202	cloe 02		212	fluke		198
aretè 02		200	crisalide		093	fluò		238
aretè L		204	crisalide mini		096	freely		144
aretè L 02		206	denise		244	ginevra		196
art		224	dolce		220	ginkgo		139
blend		169	drop		177	ginkgo biloba		142



























go		239
havana		218
(IN)finito		109
intake		188
isabella		124
leva	 <small>NEW</small>	073
leva mirror	 <small>NEW</small>	076
levante		153
linear		222
lucrezia		126
lucrezia 02		128
luxury		180

luxury 02		182
madeleine		185
mix		240
mj		245
ovum		230
pod		105
project		214
project 02		216
project zancata		236
project zancata 02		237
safety		150
short		192











sike		234
sike 02		235
silvyana		241
thelma		242
timeless		121
twist		232
twist 02		233
vita		228
viva!		135
zeppelin		165

indice / index

maniglie Premium *Premium door handles*

artik		285	luce O2		260	sochic		270
chop		266	luce p		262	sochic O2		271
elle	 <small>NEW</small>	284	luce p O2		264	sochic L		272
esa		268	minima		279	sochic L O2		273
fold		274	nova		281	stick O2		280
fold O2		275	pluris	 <small>NEW</small>	248	tipo-z		285
holly		278	quattro O2		283			
iki		255	S40		286			
joy		276	S50		286			
joy O2		277	S60		287			
link		282	san		251			
luce		258	san O2		253			

maniglie Classiche
Classic door handles

airone		298
appia		291
beauty		298
bruxelles		298
classic		294
daniela		299
fedora		295
fiore		296
fiorenza		297
lady		292
latina		290
lirica		293
lorena		299

kit hotel maniglia-pomolo <i>knob-handle hotel kit</i>	302
--	-----

sistemi per porte e finestre <i>door and window systems</i>	034
---	-----

simboli <i>symbols</i>	042
---------------------------	-----

finiture <i>finishes</i>	044
-----------------------------	-----

finiture forte [®] forte [®] finishes	046
--	-----



disegni tecnici <i>technical drawings</i>	406
--	-----

indice / *index*

maniglioni *pull handles*

aretè	318	latina	334
aretè L	319	linear	328
art	330	logo	327
C-1918	326	luce	333
C-1918 zancato	326	lucrezia	315
cloe	320	luxury	325
daniela	336	only	335
domus	321	pod	308
eleonora 	312	project	329
fluke	332	project spostato	329
ginkgo	316	solid square	322
ginkgo biloba	317	tube round	323
(IN)finito	310	tube round zancato 	324
intake	331	zeppelin	309



maniglioni per alzante scorrevole *pull handles for lift sliding system*

edra	342
edra corto	343
edra 02	340
edra 02 corto	341
liter	350
luce	348
luce 02	349
luce p 	346
luce p 02 	347
slide	344
slide corto	345
placche incasso <i>sliding door handles</i>	351



pomoli *knobs*

easy	358
fiorenza	358
lucrezia	356
lucrezia 02	357
lucrezia 03	357
project	359
quadro	355
ring	354
rondò	354
sfera	356
timeless	355

pomolini per mobili *furniture knobs*

crisalide	 360
dune	 361
timeless	362
accessori per mobili <i>furniture accessories</i>	363

maniglie per porte scorrevoli *sliding door handles*

ginkgo tonda	370	quadra	380
ginkgo quadra	372	rettangolare	383
master tonda	 366	ring	376
master quadra	 368	rondò	374
noxia	382	tonda	378

articoli vari *other complements*

nottolini <i>turn & releases</i>	386	cerniere <i>hinges</i>	402
bocchette <i>escutcheons</i>	398	placche <i>plates</i>	403
fermaporta <i>door stop</i>	401		
chiavi <i>keys</i>	401		

azienda / company

Dnd è un punto di riferimento internazionale per la realizzazione di **maniglie che guardano alla qualità e al progetto.**

La storia di Dnd inizia nel 1968 nella Val Sabbia, in provincia di Brescia: un territorio dall'antica e **spiccata dedizione artigianale e industriale**, soprattutto a vocazione siderurgica. In oltre 55 anni di sviluppo, l'azienda si è evoluta con continuità e si è concentrata sulla ricerca e sull'incremento della produzione, rinnovandone i processi e **specializzandosi nella lavorazione e nella rifinitura dei metalli** destinati alla produzione delle maniglie, in particolare l'ottone.

*Dnd is an international benchmark when it comes to producing **quality and design-oriented handles.***

*Dnd's story began in 1968, in Val Sabbia, in the province of Brescia: an area with an ancient and **strong artisan and industrial tradition**, especially as far as steel is concerned.*

*During its 55 years of business, the company has developed and evolved continuously by focusing on research, increasing production, renewing processes and **specialising in metal working and finishing**, with the end product being brass handles, amongst others.*





Dnd oggi è diretta da Vilma Martinelli con i figli Pietro e Simona. Insieme a una affiatata squadra di collaboratori, vivono e guidano ogni giorno l'azienda come una **fucina di idee** in grado di coniugare la **lunga esperienza produttiva** acquisita con la **progettualità degli architetti e dei designer** di valore che vengono puntualmente coinvolti nel disegno dei prodotti.

Dal 2017 la governance ha scelto **Giulio Iacchetti** come **direttore artistico**: un designer industriale di grande talento che è impegnato attivamente nel percorso di crescita dell'azienda, nello sviluppo del catalogo, nella selezione e nell'inclusione dei progettisti e dei consulenti per il mondo Dnd.

*Dnd is currently run by Vilma Martinelli and her sons, Pietro and Simona. Together with a close-knit team of collaborators, they ensure the company thrives on a daily basis, like a **hothouse of ideas** capable of combining their **extensive manufacturing** experience with the **planning skills of architects and designers** who are regularly involved in product design.*

*Since 2017, the governance has entrusted the role of **artistic director** to **Giulio Iacchetti**: a highly talented industrial designer who has actively contributed to the company's growth path, catalogue development, and the selection and inclusion of designers and consultants for Dnd.*

valori / values

Valori come **strategia** e come **progetto**, da seguire ogni giorno nel presente e verso il futuro. Dnd ne identifica cinque: **integrità, passione, innovazione, miglioramento e sinergia.**

Values like **strategy** and **design** that are stringently followed every day with both the present and future in mind. Dnd has identified five main values: **integrity, passion, innovation, improvement and synergy.**





made in italy



Produrre maniglie di qualità e **completamente Made in Italy da oltre cinquant'anni**: una scelta strategica di lunga data che si fonda sui valori della cultura aziendale italiana e sul profondo legame che Dnd ha nei confronti del suo territorio e del suo distretto, la Valle Sabbia in provincia di Brescia. Dnd è Made in Italy con l'orgoglio di realizzare prodotti grazie al **sapere**, alla **ricerca**, allo **stile** e alla **cura** che oggetti di piccole dimensioni – come le maniglie – richiedono. L'eccellenza e il valore del design italiano si fondano da sempre sullo sviluppare, lavorare, rifinire e collaudare in Italia: passaggi importanti a tutela di prodotti di qualità.

*To produce high-quality handles, **completely Made in Italy, for over fifty years**: a long-term strategy based on the values of an Italian corporate culture and the deep bond between Dnd and Valle Sabbia in the province of Brescia, its district and its territory.*

*Dnd is Made in Italy with pride, to create products thanks to **know-how, research, style**, and all the **care** that has to go into objects of small size such as handles.*

The excellence and value of Italian design are constants in the development, workmanship and testing, all done in Italy: important phases to guarantee products of the highest quality.

Dalla creatività ai materiali, dal disegno al progetto, dalla produzione alle finiture, maniglie che sono da sempre fatte in Italia e fatte di Italia per entrare nelle case più belle e accoglienti, per caratterizzare **progetti architettonici di pregio** e per soddisfare al meglio le personalizzazioni del mondo contract, in Italia e nel mondo.

*From creativity to materials, the drawing to the project, the production to the finishing, handles that are always made in Italy and made of Italy, to enter the most beautiful, appealing homes, to enhance **outstanding works of architecture**, to offer an optimal response to needs of customization in the contract sector, in Italy and the world.*

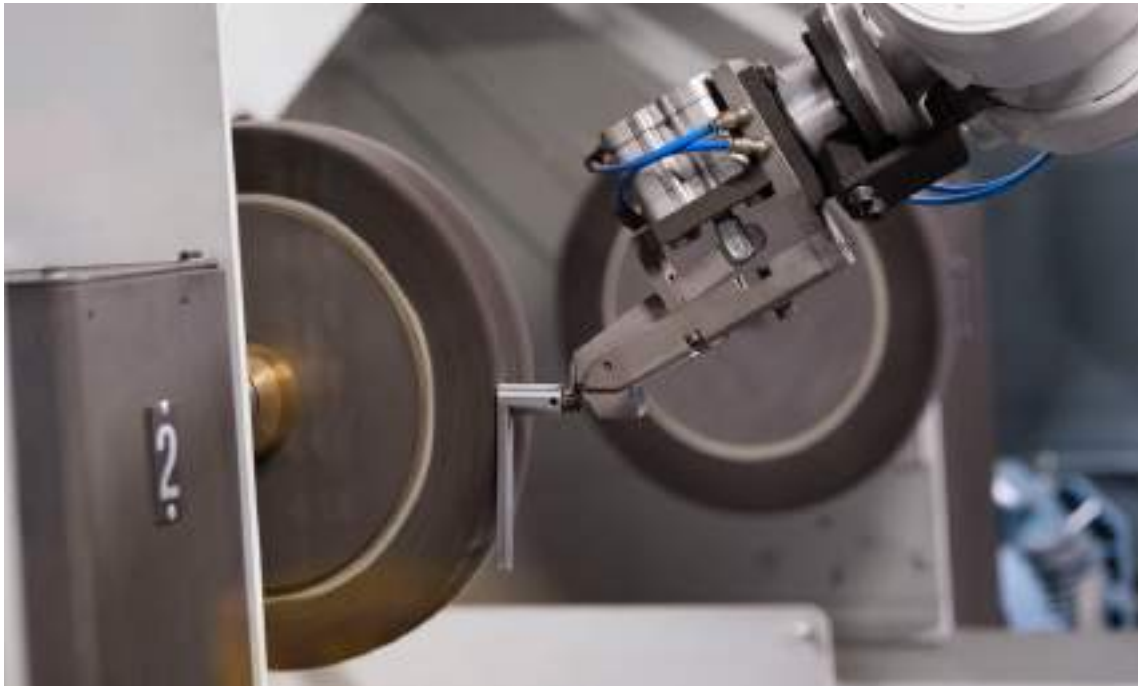

**Azienda con
certificazione sistema di
qualità UNI EN ISO 9001**

- Progettazione ottimizzata
- Costante formazione delle risorse umane
- Ambiente di lavoro controllato
- Produzione tecnologicamente avanzata
- Monitoraggio instancabile

**A company with
UNI EN ISO 9001 quality
system certification**

- *Optimized design*
- *Constant training of human resources*
- *Controlled working environment*
- *Technologically advanced production*
- *Continuous monitoring*



made together

L'azione di una realtà industriale si svolge anche in **relazione** con **enti e associazioni** che condividono con essa percorsi, tappe e impegni. Dnd è orgogliosa di essere parte di organizzazioni che mettono al centro della loro azione il **saper fare italiano**, il **design**, le **comunità** e i loro **distretti**.

*Being an industrial company also involves **working alongside organisations and associations** that share the same paths, stages and commitments. Dnd is proud to belong to organisations that put **Italian know-how, design, communities** and their **districts** at the centre of their action.*

ADIMEMBER

ADI Member

Essere socio di ADI, Associazione per il disegno industriale, per Dnd significa avere un ruolo attivo nel mondo del progetto italiano. Ed essere, insieme alle altre imprese e ai professionisti associati, tra i protagonisti dell'evoluzione del disegno industriale come fenomeno culturale ed economico del paese.

Dnd believes that being a member of ADI – Italy's Association for Industrial Design – means playing an active role in the world of Italian design. And to be, together with other companies and associated professionals, one of the prime examples of how industrial design has evolved as a cultural and economic phenomenon in this country.



Federlegno

Dnd sviluppa e realizza maniglie per porte, infissi e mobili, in dialogo costante con il mondo dell'arredo. L'adesione a Federlegno permette di partecipare a una continua attività di formazione, a un'adeguata consulenza in ambito normativo e consente anche guardare in una direzione strategica per affrontare nuovi mercati e nuove sfide.

Dnd develops and creates handles for doors, fixtures and furniture, by constantly liaising with the furnishing sector. Becoming a member of Federlegno has allowed the company to participate in on-going training activities, receive adequate consultancy as far as regulations are concerned and be provided with a strategic direction to conquer new markets and face new challenges.



Confindustria

In quanto impresa manifatturiera, Dnd è protagonista di quel “saper fare” che è da sempre uno degli asset dell’Italia. Per questo motivo, e per la volontà di fare rete con le aziende del territorio, Dnd è associata a Confindustria Brescia, tra le più antiche associazioni industriali del Paese, di cui fanno parte circa 1300 realtà.

As a manufacturing company, Dnd is the flag bearer of a “know-how” that has always been one of Italy’s assets. For this reason and the desire to network with local companies, Dnd is registered with Confindustria Brescia, which is one of the oldest industrial associations in the country, with roughly 1300 companies under its wing.



Fondo territoriale per la Valle Sabbia

L’attenzione e la salvaguardia del territorio si esprimono sotto diverse forme. Dnd ha aderito al Fondo Territoriale per la Valle Sabbia al fine di promuovere opportunità di crescita e coesione e offrire un supporto alla resilienza della valle, attraverso la ricerca di fondi per lo sviluppo di politiche di intervento dedicate alle fasce sociali più deboli.

The local area is looked after and protected in different ways. Dnd joined the Local Fund for Valle Sabbia to promote opportunities for growth and cohesion, whilst supporting the valley’s resilience by helping acquire funds to develop dedicated intervention policies for society’s most vulnerable groups.



Una veduta del territorio: Lago d’Idro e Valle Sabbia, in provincia di Brescia.
A view of the area: Lake Idro and Valle Sabbia, in the Italian province of Brescia.

Photo: Federico Pasinetti

responsabilità / *responsibility*



Dnd è felice di promuovere ogni giorno **azioni e processi attenti all'ambiente** e si impegna in diversi progetti legati alla sostenibilità al fine di migliorare la salute del luogo di lavoro e sviluppare un senso di **responsabilità come strategia** e come scelta.

Dal 2023, la sede dell'azienda è direttamente coinvolta nella produzione – e dunque nell'utilizzo – delle **energie rinnovabili** che sono generate da un **nuovo impianto fotovoltaico** da 218 chilowatt di picco. L'impianto copre il **fabbisogno energetico** della produzione aziendale ed è formato da 396 moduli da 550 watt di picco ciascuno, per una superficie fotovoltaica totale di 1023 mq.

*Dnd is happy to promote **environmentally-friendly actions and processes** every day, and is involved in a number of sustainability-related projects to put health at the centre of the workplace and develop a sense of **responsibility, as a strategy and a choice.***

*Since 2023, the company headquarters has been directly involved in the production – and therefore use – of **renewable energy**, thanks to the installation of a new 218 peak kilowatt **photovoltaic system**. The system covers the **energy needs** of the company's production and comprises 396 modules with 550 peak watt capacity each, for a total photovoltaic surface of 1023 m².*



L'impianto fotovoltaico sovrastante la sede di Dnd, a Casto.
The photovoltaic system above the Dnd headquarters in Casto.



**Stampa a freddo /
 Cold printing**

Dnd ha sostituito il sistema di stampa degli uffici con i prodotti Epson Inkjet per la stampa a freddo, che riducono i costi e i consumi energetici fino all'83% rispetto alle stampanti laser.

Dnd has replaced the office printing system with Epson Inkjet cold press printing products, which reduce costs and energy consumption by up to 83%, compared to laser printers.



FSC®

L'impegno è quello di usare il minor quantitativo di carta possibile: l'azienda ha ridotto del 50% il consumo e sceglie per listini e cataloghi solo carta certificata FSC®.

The company strives to go as paperless as possible: it has reduced consumption by 50% and solely uses FSC®-certified paper for its price lists and catalogues.

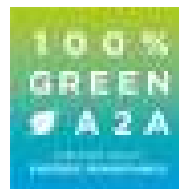

100% GREEN A2A

Certificazione della Camera di Commercio di Brescia che garantisce l'impiego di energia derivante da fonti che sono al 100% rinnovabili.

Certification from the Brescia Chamber of Commerce which guarantees the use of energy derived from 100% renewable sources.



WeForest

Dnd compensa il consumo di carburante dei propri automezzi e delle proprie autovetture con il sostegno di un progetto di rimboscimento in atto nella regione del Katanino, in Zambia.

Dnd offsets the fuel consumption of its vehicles and cars by supporting an ongoing reforestation project in the Katanino region of Zambia.

il design come valore / *design as a value*

A partire dagli anni Duemila, Dnd ha deciso di **dedicare la propria esperienza produttiva al settore del design**, indirizzando con decisione la ricerca e lo sviluppo dei prodotti verso quegli standard di disegno e qualità che il mondo del progetto richiede, a livello italiano e internazionale.

Fare parte del mondo del design implica la costruzione di una identità aziendale solida e consapevole, orientata con **continuità e passione verso il progetto** e dunque verso la creatività e l'innovazione. E verso il **fatto bene**, attraverso grande cura e perizia.

*Since the 2000s, Dnd has chosen to **dedicate its manufacturing experience to the design sector**, by decisively orienting its product research and development towards the worldwide industry-specific design and quality standards, at both a national and international level.*

***Being part of the design world** implies building a concrete yet conscious corporate identity with a **continuous and passionate approach to design** and therefore oriented towards creativity and innovation. In addition to **doing things well**, with great care and expertise.*

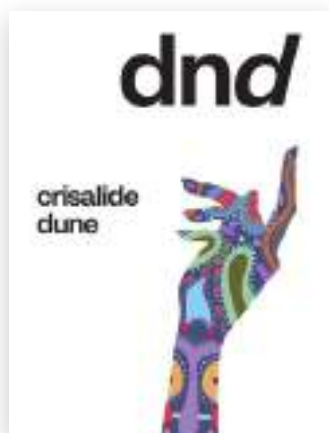

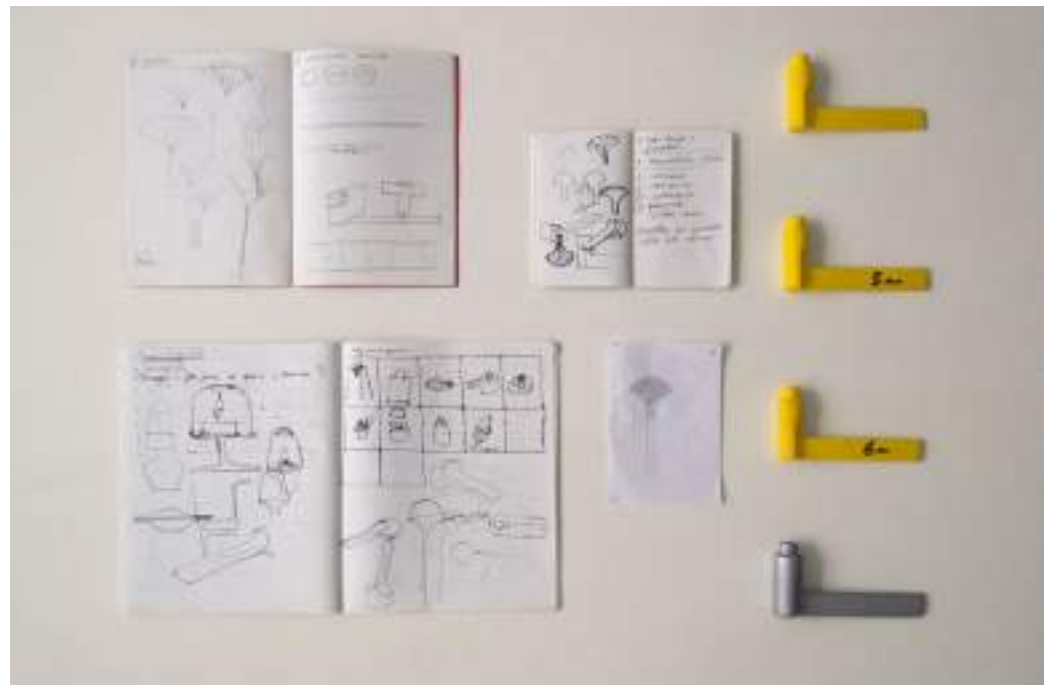



Video:
Dnd al Salone
del Mobile

Video:
Dnd at Salone
del Mobile



L'impegno di Dnd nel mondo del design contemporaneo è stato ulteriormente suggellato nel 2017 con il coinvolgimento di **Giulio Iacchetti** come **direttore artistico**. Questa preziosa e proficua collaborazione ha portato l'azienda a declinare con sempre maggiore puntualità il **linguaggio del design** nei suoi prodotti, dal disegno ai dettagli, dalle finiture all'aggiornamento tecnologico.

Le qualità delle maniglie Dnd sono riconosciute a **livello internazionale** e hanno ottenuto **premi e riconoscimenti** in importanti concorsi di design.

*Dnd's commitment to the contemporary design sector was further sealed in 2017, when **Giulio Iacchetti** took on the role as **artistic director**. This valuable and fruitful collaboration has allowed the company to more fluently express its **design language** through its products, from the design to the details, finishes and technological advancements.*

*By dint of the qualities that the Dnd handles possess, they have garnered **international recognition** and led to **awards** and special mentions in some of the major design contests.*



Selected
ADI DESIGN INDEX

2023 – Leva
Design by Park Associati

2023 – Vertical system
Design by Dnd

2019 – (IN)finito
Design by Alfonso Femia



Winner
Archiproducts Awards

2023 – Crisalide
Design by Elena Salmistraro

2022 – Pod
Design by Holscher Design



Winner
Good Design Awards

2017 – Ginkgo
Design by Giulio Iacchetti

progettisti / designers

La collaborazione con i designer è **parte fondamentale** del processo produttivo e creativo di Dnd. Con continuità e attenzione, l'azienda coinvolge **progettisti italiani e internazionali** di grande talento, esponenti del miglior mondo del progetto. Voci tra loro differenti per stile e approccio, che hanno contribuito a generare un **catalogo molto articolato** di oggetti che spiccano per disegno e realizzazione.

*Collaborating with designers is a **fundamental part** of Dnd's manufacturing and creative process. The company continuously and painstakingly works alongside highly **talented Italian and international designers**, who epitomise the best in the world of design. By dint of these designers' individual styles and approaches, Dnd is proud to offer an **ultra-detailed range of products** that stand out as far as design and production are concerned.*

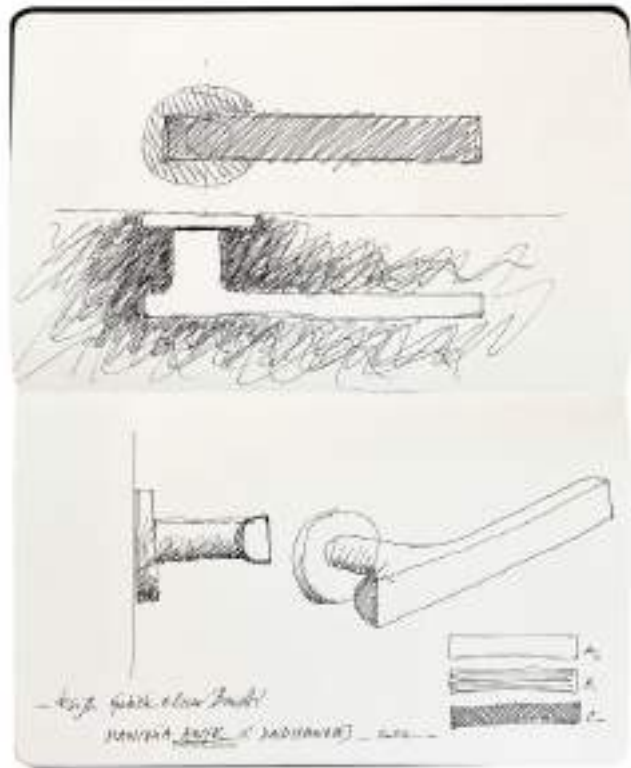



Stefano Boeri
Architetti



**Gabriele &
Oscar Buratti**



**Achille
Castiglioni**



**Gianfranco
Cavaglià**



**Alfonso
Femia**



**Odo
Fioravanti**



**Jaime
Hayon**



**Holscher
Design**



**Studio
Hot Lab**



**Giulio
Iacchetti**



**Enrico
Martini**



**Andrea
Morgante**



**Luca
Nichetto**



**Nicola
Novelletto**



**Mario
Padiglione**



**Park
Associati**



**Marco
Pisati**



**Karim
Rashid**



**Mauro
Ronchi**



**Elena
Salmistraro**



**Sandro
Santantonio**



**Mario
Scairato**



**Didier
Schweizer**



**Inga
Sempé**



**Alessandro
Stabile**



**Philippe
Tabet**



**Maurizio
Varratta**



**Cino
Zucchi**



967arch

realizzazioni / *projects*

Le maniglie Dnd vengono scelte per valorizzare interni domestici e pubblici, in **tutto il mondo**. Inoltre, l'azienda offre una **consulenza diretta** ad architetti e designer per selezionare al meglio prodotti e finiture e valutare insieme **soluzioni personalizzate**.

Dalle positive **relazioni di scambio con i progettisti e i costruttori** degli ambienti architettonici nascono racconti interessanti: Dnd è felice di condividere immagini e pensieri relativi a questi progetti di interni, frutto di impegno e creatività.

*Dnd handles have been chosen to enhance both domestic and public interiors, **all over the world**. Furthermore, the company offers **direct consultancy** to architects and designers to best select the products and finishes, and identify **custom solutions** together.*

*Interesting stories have arisen from these **positive exchanges with the designers and builders** of architectural environments: Dnd is proud to share images and feedback received regarding these interior projects, which are the result of hard work and creativity.*



C.Space Office
Milano - IT
Project by
co.arch studio
Ph: Luca Privitera



**Early
Medical Center
Singapore – SN**
Project by
Antimatter
Ph: Hosanna Swee



**Raionul de Peste
Bucarest – RO**
Project by
Karim Rashid
Ph: Sebastian Stan



**La Terraza
del Casino
Madrid - ES**
Project by
Hayon Studio
Ph: KlunderBie



**Me Do Re
Tower
Dubai - AE**

Realizzazioni internazionali con maniglie Dnd
International projects with Dnd handles

Acro Seoul Forest, KR
Bab Atlas, MO
Bank of Jerusalem, IL
Barclays, GB
ILG Bel Air, US
Cabra, IE
Caja de Badajoz, ES
Claridge's Hotel, GB
Hotel Conrad Cairo, EG
Hotel Kempinski, HR
Hotel Mandarin Oriental, US
Kai Tak Residence, HK
Le Palais Gallien, FR
Posco Tower, KS
Royale Belge, BE
Terminal Roissy, FR
The Parliament building, GB
The Ritz Carlton Hotel, CH

Allianz Tower
Milano - IT
Project by A. Isozaki &
A. Maffei Architects
Ph: Jean-Michel Byl



Fidenza Village
Fidenza - IT
Project and photo
by Solids Studio

dndmagic



“Dnd Magic” è una **piattaforma multifunzione** ideata da Dnd.

Si tratta di uno strumento che agevola i flussi di lavoro e li organizza, in contatto diretto con l’azienda.

È uno strumento in continua evoluzione, grazie al quale Dnd garantisce soluzioni e **servizi innovativi per i distributori**, gli **architetti** e i **progettisti**. Dnd magic, inoltre, è anche un efficace **configuratore** e permette di visualizzare, scegliere e ambientare in spazi diversi tutte le maniglie del catalogo, nelle tante finiture disponibili.

*“Dnd Magic” is the **multifunctional platform** created by Dnd. It is a tool that both facilitates and organises workflow, in direct contact with the company.*

*Thanks to this ever-evolving tool, Dnd is able to guarantee **innovative solutions and services for distributors, architects and designers**. Furthermore, Magic also serves as an effective **configurator** that allows clients to view, choose and set up all the handle models found in the catalogue, with the various finish options, in different spaces.*



Per scoprire le funzionalità di **dndmagic**

To discover the features of **dndmagic**

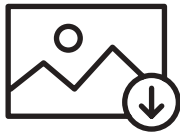

Area download / Download area

Un'area in cui scaricare le immagini e i video in alta definizione, i render e le schede dei prodotti Dnd. A disposizione ci sono anche le immagini e le biografie dei designer, le grafiche utilizzate nei social e il materiale per la comunicazione.

High-definition images and videos can be downloaded from this area, in addition to renderings and the data sheets of both Dnd and Poggi & Mariani products. Other materials are also at hand: images and biographies of the different designers, the graphics used on social media platforms and communication material.

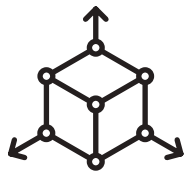

Libreria 3D / 3D library

Una sezione in cui scaricare i file 3D di tutti i prodotti Dnd, così da poterli inserire e utilizzare nei progetti architettonici per una resa ottimale.

The 3D files of all Dnd products can be downloaded from this section and subsequently inserted and used in architectural projects for optimal results.

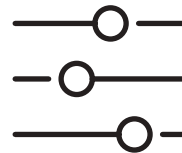

Configuratore / Configurator

Visualizzare prodotti e componenti per poi inserirli in tante e diverse ambientazioni di interni: il configuratore è una delle principali funzioni di **dndmagic**. E permette di salvare o scaricare la configurazione prescelta.

*View products and components, before inserting them into the wide range of interior settings: the configurator is one of the main features of **dndmagic**. It also allows the chosen configuration to be saved or downloaded.*

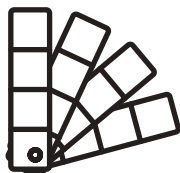

Prodotti / Products

Lo spazio in cui visualizzare i prodotti di ogni categoria, scoprire i modelli, le varianti, le finiture e scaricare la scheda tecnica di ogni prodotto.

View all the product categories, models, variants and finishes from this section. The technical data sheet for each product can also be downloaded here.



Cataloghi / Catalogues

La sezione in cui sfogliare i cataloghi Dnd, sempre aggiornati. Oppure scaricare direttamente la copia digitale per poterla avere a disposizione.

Leaf through the ever-updated Dnd catalogues in this section. You can even download a digital copy, should that suit you better.

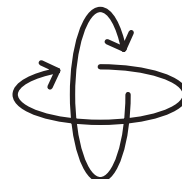

Visita virtuale Virtual tour

Uno showroom virtuale tutto da esplorare, per vedere i prodotti e sfogliare i cataloghi. Da quest'area è possibile anche prenotare una visita in azienda oppure richiedere una consulenza diretta.

A virtual showroom where you can explore, view the products and browse the catalogues. You can also book a company visit or request direct consultancy from this section.

– door and

sistemi
per porte
e finestre

window systems

Il sistema Unico

Unico, the system



minimal,
elegant,
Unico

Unico è il sistema per porte – ideato da Dnd – che riduce al minimo l'impatto visivo della rosetta sulla maniglia, valorizzandone così il design: una soluzione tecnica ed estetica ideale per gli ambienti contemporanei.

Grazie al suo piccolo volume, risulta poco visibile: misura solo 30 mm di diametro e 2 mm di spessore. Il sistema, proposto in forma rotonda, è facile da installare e prevede la realizzazione di un foro da 22 mm sulla porta.

Unico is the system for doors – designed by Dnd – that minimises the visual impact of the rose on the handle, thus enhancing its design: a technical and aesthetic solution that is ideal for contemporary interiors.

Thanks to its small volume, it is hardly visible: it measures only 30 mm in diameter and 2 mm in thickness. The system, which comes in a round shape, is easy to install and requires a 22 mm hole to be drilled in the door.



crisalide mini
ANE + PSW



san
ZCS



leva
PGS | forte®



levante
PVD-SG | forte®

Sistema disponibile su 33 modelli
in tutte le loro finiture
*System available on 33 models
in all their finishes*



2413+A



BD80Y



BD80P

**nottolino e bocchette /
turn & release and escutcheons**



Sistema Unico disponibile anche per finestre / *Unico System available also for windows*



luce p
ZCS



short
PGS | forte®



anik line
PVD-SG | forte®



leva
ONO

Il sistema Unico è disponibile anche per serramenti, su cui la discrezione della rosetta – di soli 34 mm di diametro e 10 mm di spessore – esalta pienamente la forma e il disegno della maniglia. Sistema DK a 8 scatti, facile da installare con la realizzazione di un foro da 13 mm sul serramento.

The Unico system is also available for windows, where the discretion of the rose – just 34 mm in diameter and 10 mm in thickness – fully enhances the shape and design of the handle. DK 8 position-system, easy to install by drilling a 13 mm hole in the frame.

Sistema Less is fine 4 mm / *Less is fine system 4 mm*

FINE

FINE

Porta / Door

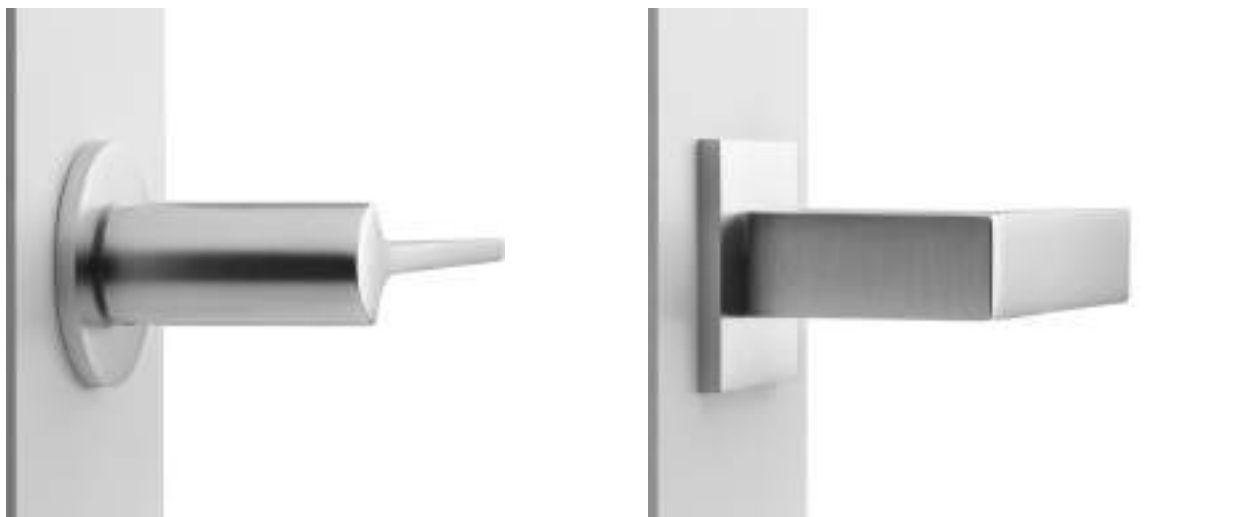

Il sistema Less is fine – di soli 4 mm – nasce grazie alle più recenti tendenze dell'architettura. In soli 4 mm si trova la rosetta metallica con con molla uni-direzionale destra o sinistra (a compressione), la quale permette un'installazione senza lavorazioni aggiuntive sulla porta. Brevetto Dnd.

The Less is fine system has a thickness of just 4 mm and it has been developed in tune with the latest design trends. In just 4 mm is the metal rose with uni-directional right or left compression spring, which allows installation without additional working on the door. Dnd patent.

Componenti tecnici / Technical components



Less is fine

Sistema Vis 7 mm / VIS 7 mm system

VIS

VIS

Porta / Door



Componenti realizzati in nylon PA6 con molla uni-direzionale destra o sinistra. Rosette con diametro 50 mm e spessore 7 mm. Fori per fissaggio legno e interasse 38 mm per viti a connessione con o senza bussole. Il sistema e la molla interna sono stati testati e certificati dal Laboratorio AQM - Cert.2012-1000/Ppe, in base all normativa UNI EN 1906.

Test di tenuta e usura dei componenti meccanici. Simulazione di apertura e chiusura oltre: 200.000 cicli.

Categoria d'uso Grado 3: alta frequenza d'uso da parte del pubblico o scarsa cura; alte probabilità d'uso improprio.

Durabilità Grado 7: frequenza d'uso elevata, 200.000 cicli.

Azionamento Tipo B, serrature caricate a molla.

The parts are made with PA6 nylon, with uni-directional left or right spring. The backplate has a diameter of 50 mm and a thickness of 7 mm. Holes for attachment to wood, 38 mm centering, with or without connector nuts. The inner spring and system are certified by AQM - Cert.2012-1000/Ppe in keeping with UNI EN 1906 standards.

Mechanical components wear and tear test. Opening and closing simulation to more than 200.000 cycles.

Category of use Grade 3: high frequency of use by the public or with little care; high

*chance of misuse. **Durability** Grade 7: high frequency of use, 200.000 cycles.*

Type of operation B, spring-loaded locks.

Componenti tecnici / Technical components



VIS



VIS

Sistema 52 - 10 mm / 52 - 10 mm system

52

52

Porta / Door

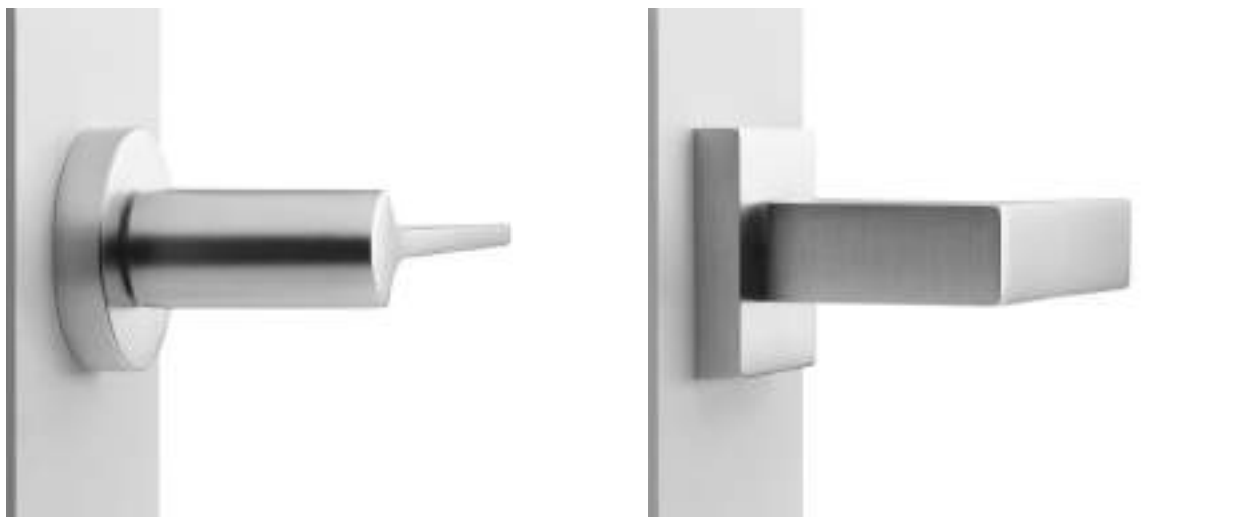

Componenti realizzati in metallo con molla bi-direzionale destra/sinistra. Rosette con diametro 52 mm e spessore 10 mm. Fori per fissaggio legno e interasse 38 mm per viti a connessione con o senza bussole.

The parts are in metal, with bi-directional left/right spring. The backplates have a diameter of 52 mm and a thickness of 10 mm. Holes for attachment to wood, 38 mm centering, with or without connector nuts.

Componenti tecnici / *Technical components*



52

DK VIS 9 mm



Finestra / Window



Il DK VIS nasce dall'esigenza di ottenere un sistema esteticamente combinato con il sistema VIS per porta. Le componenti tecniche restano così più discrete e lasciano pieno spazio al design della maniglia. Un meccanismo facile e veloce da montare, senza la necessità di lavorazioni sul serramento.

DK VIS is the result of the need for aesthetic coordination with the VIS system for doors. The technical components remain more discreet to offer greater freedom in the design of the handle. The mechanism is easy and quick to assemble.

DK VIS TS 9 mm



Il DK anti intrusione con pulsante di sicurezza.

Sempre in 9 mm, sempre senza lavorazioni. Studiato appositamente per evitare che, forando il serramento dall'esterno, sia possibile azionare il meccanismo. TSDK non richiede lavorazioni e può essere installato anche in sostituzione a modelli precedenti. Inoltre è configurabile con tutti i modelli a catalogo.

The DK anti-intrusion model with security latch.

Still with a thickness of 9 mm, without the need for complicated installation operations. Specially designed to avoid the possibility of opening by drilling from the outside. TSDK does not require machining and can also be installed in place of previous models. It can also be coordinated with all the models in the catalogue.

simboli / symbols

Porta / Door

- VIS** **50x7 mm**
rosetta-bocchetta tonda
round rose-escutcheon
- FINE** **50x4 mm**
rosetta-bocchetta tonda
round rose-escutcheon
- 52** **52x10 mm**
rosetta-bocchetta tonda
round rose-escutcheon
- B** **50x10 mm**
rosetta-bocchetta tonda bombata
rounded rose-escutcheon
- R** rosetta-bocchetta speciale
special rose-escutcheon
- S** **30x60x10 mm**
rosetta-bocchetta stretta ovale
narrow oval rose-escutcheon
- U** **30x2 mm**
rosetta minimal Unico
minimal Unico rose
- U** **25x2 mm**
bocchetta minimal Unico
minimal Unico escutcheon
- VIS** **50x7 mm**
rosetta-bocchetta quadra
square rose-escutcheon
- FINE** **50x4 mm**
rosetta-bocchetta quadra
square rose-escutcheon
- 45** **45x10 mm**
rosetta-bocchetta quadra
square rose-escutcheon
- 52** **52x10 mm**
rosetta-bocchetta quadra
square rose-escutcheon
- R** rosetta-bocchetta speciale quadra
special square rose-escutcheon
- S** **30x60x10 mm**
rosetta-bocchetta stretta rettangolare
narrow rectangular rose-escutcheon

Finestra / Window

- VIS** **31x64x9 mm**
rosetta ovale per DK VIS
DK VIS oval rose
- U** **31x64x9 mm**
rosetta ovale per DK VIS TS - sicurezza
DK VIS TS oval rose for security latch
- U** **34x10 mm**
rosetta minimal Unico per DK
DK minimal Unico rose
- VIS** **31x64x9 mm**
rosetta rettangolare per DK VIS
DK VIS rectangular rose
- U** **31x64x9 mm**
rosetta rettangolare per DK VIS TS - sicurezza
DK VIS TS rectangular rose for security latch
- R** **31x64x12 mm**
rosetta Dnd rettangolare pesante per DK
Dnd rectangular heavy rose for DK

finiture

– finishes





finiture / finishes

Finiture su ottone / Brass finishes

OLV	Lucido <i>Polished</i>
OS	Satinato <i>Satin</i>
SO	Sabbiato opaco <i>Matt sandblasted</i>
ORO	Placcato oro 24K <i>Gold plated 24K</i>
BSO	Bronzo sabbiato opaco <i>Matt sandblasted bronze</i>
OGC	Bronzo satinato lucido <i>Bright satin bronze</i>
OGH	Bronzo satinato opaco <i>Matt satin bronze</i>
AF	Anticato <i>Antique finish</i>
BSS	Bronzo scuro sfumato <i>Shaded dark bronze</i>
AB	Bronzato <i>Antique bronze</i>
OC	Cromo lucido <i>Polished chrome</i>
OCS	Cromo satinato <i>Satin chrome</i>
CCS	Cromo - Cromo satinato <i>Chrome - Satin chrome</i>
ONV	Nickel lucido <i>Polished nickel</i>
ONS	Nickel satinato <i>Satin nickel</i>
FAN	Ferro anticato <i>Antique iron</i>
OBN	Bianco <i>White</i>
BNL	Bianco lucido <i>Bright white</i>

ONO	Nero <i>Black</i>
OVE	Verde <i>Green</i>
TAN	Antracite <i>Anthracite</i>

forte® Finiture PVD su ottone / PVD finishes on brass

PVD-SH forte®	Oro champagne satinato <i>Champagne satin gold</i>	
PVD-SB forte®	Bronzo satinato <i>Satin bronze</i>	
PVD-BB forte®	Bronzo lucido <i>Bright bronze</i>	
PVN forte®	Nickel lucido <i>Bright nickel</i>	
PVD forte®	Oro lucido <i>Bright gold</i>	
PVD-BG forte®	Oro antico lucido <i>Antique bright gold</i>	
PVD-SG forte®	Oro antico satinato <i>Antique satin gold</i>	
PVD-SCB forte®	Rame satinato <i>Satin copper</i>	
PGS forte®	Grafite satinato <i>Satin graphite</i>	
PVX forte®	Inox satinato <i>Satin steel</i>	

**Finiture su zama /
Zamak finishes**

ZOS	Ottonato satinato <i>Satin brass colour</i>
ZGH	Bronzo satinato opaco <i>Matt satin bronze</i>
ZC	Cromo lucido <i>Polished chrome</i>
ZCS	Cromo satinato <i>Satin chrome</i>
ZNS	Nickel satinato <i>Satin nickel</i>
ZBN	Bianco <i>White</i>
ZNE	Nero <i>Black</i>
ZAN	Antracite <i>Anthracite</i>
ZBR	Bronzo <i>Bronze</i>
ZRO	Oro satinato <i>Satin gold</i>
ZOR	Placcato oro 24K <i>Gold plated 24K</i>

**Finiture su alluminio /
Aluminium finishes**

ACS	Cromo satinato <i>Satin chrome</i>
ASV	Silver <i>Silver</i>
ARO	Oro satinato <i>Satin gold</i>
ABR	Bronzo <i>Bronze</i>
ABN	Bianco <i>White</i>
ANE	Nero <i>Black</i>
AAN	Antracite <i>Anthracite</i>
ABT	Turchese <i>Turquoise</i>
AVP	Violetto pastello <i>Pastel violet</i>
AGO	Giallo oliva <i>Yellow olive</i>
ABC	Blu colomba <i>Blue dove</i>

**Finiture su acciaio inox /
Stainless steel finishes**

S316	Acciaio AISI 316 satinato <i>AISI 316 satin steel</i>
S316/N	Nero <i>Black</i>
L316 + R	AISI 316 lucido + inserto rame PVD <i>AISI 316 polished + PVD copper insert</i>

S316 + R	AISI 316 satinato + inserto rame PVD <i>AISI 316 satin + PVD copper insert</i>
L316 + N	AISI 316 lucido + inserto rame nero <i>AISI 316 polished + copper black insert</i>
S316 + N	AISI 316 satinato + inserto rame nero <i>AISI 316 satin + copper black insert</i>

forte®

PVD, alta qualità nella tecnologia del rivestimento

forte® è il termine coniato da Dnd per identificare e dare enfasi alla speciale finitura per maniglie che si ottiene grazie alla tecnologia di rivestimento PVD.

Acronimo di **Physical Vapour Deposition**, PVD è una tecnologia di rivestimento per prodotti di alta qualità dalle eccellenti caratteristiche chimiche e tecniche, quali alta durezza, resistenza all'abrasione, ai graffi e alla corrosione.

Un rivestimento che è **perfettamente sostenibile**, a impatto ambientale ridotto e **ipoallergenico**.

PVD: high quality in coating technology

forte® is the term coined by Dnd to identify and emphasise the special finish for handles that is achieved thanks to PVD coating technology.

An acronym for **Physical Vapour Deposition**, PVD is a coating technology for high quality products with excellent chemical and technical characteristics, such as high hardness, resistance to abrasion, scratching and corrosion.

A coating that is **perfectly sustainable**, with low environmental impact and it is **hypoallergenic**.

NEW



PVD-SH forte®
Oro champagne satinato /
Champagne satin gold

NEW



PVD-SB forte®
Bronzo satinato /
Satin bronze

NEW



PVD-BB forte®
Bronzo lucido /
Bright bronze

NEW



PVN forte®
Nickel lucido /
Bright nickel



PVD forte®
Oro lucido /
Bright gold



PVD-BG forte®
Oro antico lucido /
Antique bright gold



PVD-SG forte®
Oro antico satinato /
Antique satin gold



PVD-SCB forte®
Rame satinato /
Satin copper



PGS forte®
Grafite satinato /
Satin graphite



PVX forte®
Inox satinato /
Satin steel

Leggere variazioni cromatiche sono da considerarsi normali / Slight colour variations are to be considered normal

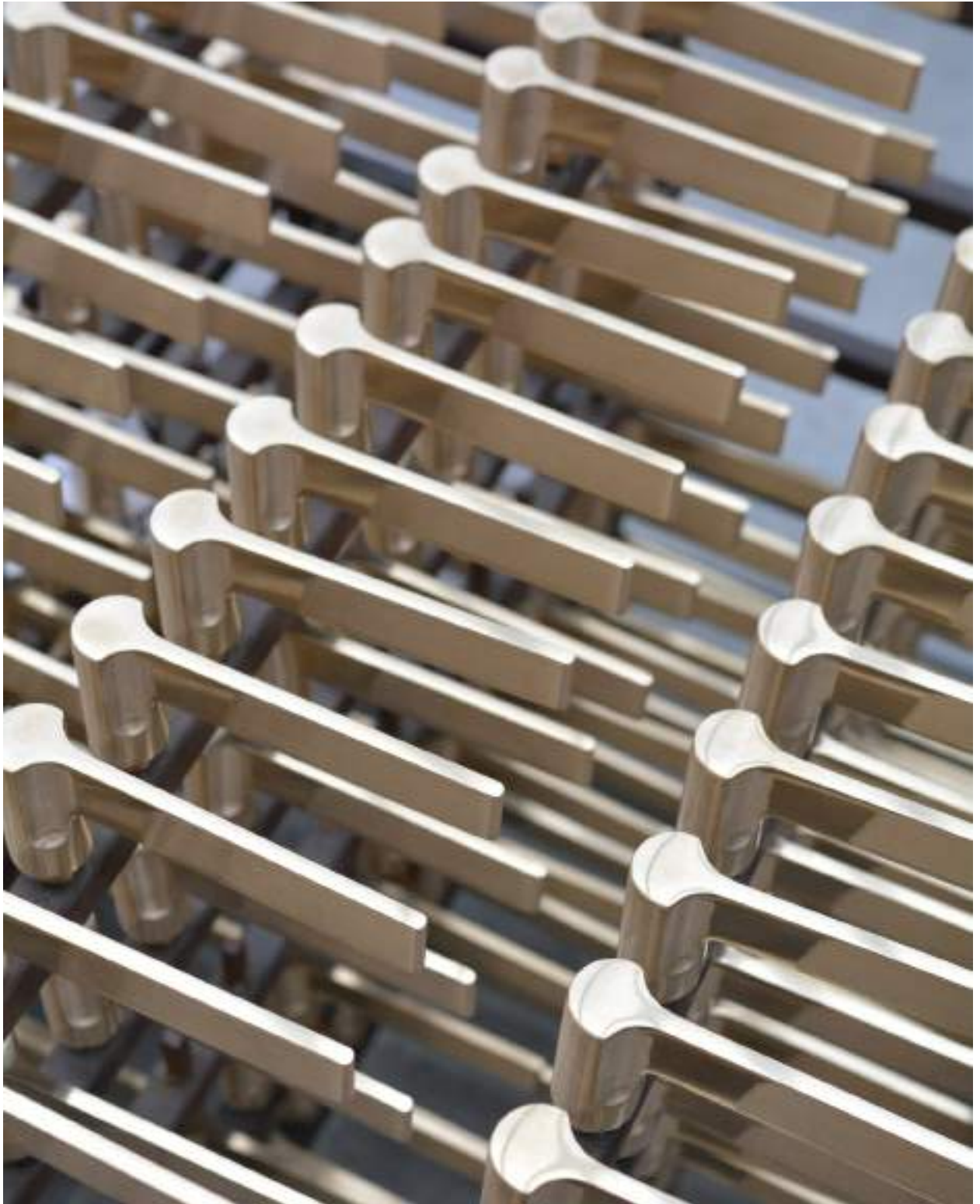

PVD-SH | forte®

Oro champagne satinato /
Champagne satin gold



PVD-SH | forte®

Oro champagne satinato.

Una texture elegante e finemente satinata che stupisce per il suo colore unico, capace di illuminare e caratterizzare interni sobriamente ricercati. Finitura garantita 20 anni.

PVD-SH | forte®

Champagne satin gold.

An elegant texture with a fine satin finish that sets the scene with its unique hue, which both illuminates and characterises subtly refined interiors. Finish guaranteed for 20 years.

anik line
Gabriele &
Oscar Buratti

forte[®]



PVD-SB | forte®

Bronzo satinato /
Satin bronze



PVD-SB | forte® **Bronzo satinato.**

Il caldo colore del bronzo con un effetto satinato: un tono scuro e al contempo non statico, in grado di riflettere la luce e stupire in interni dagli stili più differenti. Finitura garantita 10 anni.

PVD-SB | forte® **Satin bronze.**

A warm bronze shade with a satin effect: a dark yet non-static tone, able to reflect light and set the scene, no matter the interior style. Finish guaranteed for 10 years.

anik
Gabriele &
Oscar Buratti

forte[®]



PVD-BB | forte®

Bronzo lucido /
Bright bronze



PVD-BB | forte®
Bronzo lucido.

Elegante e caldo. Una tonalità della famiglia del marrone che stupisce per brillantezza e risalta in ambienti domestici molto attenti agli abbinamenti dei toni tra arredi, accessori e superfici. Finitura garantita 10 anni.

PVD-BB | forte®
Bright bronze.

Elegant and warm. A brownish hue with a statement shine and distinctive look in domestic environments that focus on colour combinations when it comes to furnishings, accessories and surfaces. Finish guaranteed for 10 years.

(IN)finite
Alfonso Femia

forte[®]



PVN | forte®

Nickel lucido /
Bright nickel



PVN | forte® **Nickel lucido**

Una cromatura a specchio caratterizzata da un tono caldo, dato dalla presenza del nickel. Una finitura versatile, fresca e luminosa, adatta agli ambienti più diversi. Finitura garantita 20 anni.

PVN | forte® ***Bright nickel.***

A mirror-effect chrome plating with a warm tone, thanks to the presence of nickel. A versatile, fresh and bright finish that is suitable for the most diverse settings. Finish guaranteed for 20 years.

anik brilliant
Gabriele &
Oscar Buratti

forte[®]



PVD-BG | forte®

Oro antico lucido /
Antique bright gold



PVD-BG | forte®
Oro antico satinato.

Solido, raffinato e senza tempo, un tono dell'ottone in grado di valorizzare al meglio sia ambienti dal sapore di un tempo, sia interni dal disegno minimale.
Finitura garantita 20 anni.

PVD-BG | forte®
Antique satin gold.

*Solid, refined and timeless, a tone of brass that is at its best in settings with the spirit of bygone days, but also in contexts of minimalist design.
Finish guaranteed for 20 years.*

madeleine
Inga Sempé

forte[®]



PVD-SG | forte®

Oro antico satinato /
Antique satin gold



PVD-SG | forte®
Oro antico lucido.

Il colore dell'ottone proposto in una tonalità più calda: per un segno brillante e luminoso, dal fascino intramontabile. Finitura garantita 20 anni.

PVD-SG | forte®
Antique bright gold.

The colour of brass in a warmer tone: for a bright, luminous presence of timeless charm. Finish guaranteed for 20 years.

ginkgo
Giulio Iacchetti

forte®



PVD-SCB | forte®

Rame satinato /
Satin copper



PVD-SCB | forte®

Rame satinato.

Ottone con finitura rame satinato. Dall'aspetto prezioso e dal grande fascino, il colore del rame sorprende e valorizza maniglie accolte in interni domestici dal carattere ricercato e dalla forte identità. Finitura garantita 10 anni.

PVD-SCB | forte®

Satin copper.

Brass with satin copper finish. With a precious image of great charm, the colour of copper surprises and enhances handles in domestic interiors with an elegant character of forceful identity. Finish guaranteed for 10 years.

drop
Cino Zucchi

forte[®]



PGS | forte®

Grafite satinato /
Satin graphite



PGS | forte®
Grafite satinato.

Ottone con finitura grafite satinato.
Un tono tra il grigio scuro e il nero: un
colore originale per far emergere l'oggetto
maniglia in ambienti connotati da una
grande attenzione al progetto.
Finitura garantita 10 anni.

PGS | forte®
Satin graphite.

*Brass with satin graphite finish.
A tone between dark gray and black:
an original colour to make the
handle stand out in contexts
of great design refinement.
Finish guaranteed for 10 years.*

blend
967arch

forte[®]



PVX | forte®

Inox satinato /
Satin steel



PVX | forte®
Inox satinato.

Ottone con finitura Inox.
La tonalità contemporanea
dell'acciaio inossidabile satinato,
perfettamente adattabile ad
ambienti domestici e pubblici.
Finitura garantita 20 anni.

PVX | forte®
Satin steel.

*Brass with stainless steel finish.
The contemporary tone of
satin-finish stainless steel adapts
perfectly to both domestic and
public spaces.
Finish guaranteed for 20 years.*

boole
Odo Fioravanti

forte[®]



Finiture cromate / Chrome finishes

Finiture galvaniche da cromo e nickel
per superfici lucide e satinare.

*Chrome and nickel galvanic finishes for
polished and brushed surfaces.*



OC
Cromo lucido
Polished chrome



OCS
Cromo satinato
Satin chrome



ONV
Nickel lucido
Polished nickel



ONS
Nickel satinato
Satin nickel

Finiture dorate / Golden finishes

Il prestigio dell'ottone reso brillante o
satinato tramite spazzolature e finiture
artigianali realizzate da mani esperte.
Placcature di oro 24K per rendere
ancora più raffinate le superfici.

*The prestige of brass, honed or satined by
brushing and handmade finishing by skilled
artisans. The 24K gold plating makes the
surfaces even more refined.*



OLV
Lucido
Polished



OS
Satinato
Satin



SO
Sabbato opaco
Matt sandblasted



ORO
Placcato oro 24K
Gold plated 24K

Finiture bronzate / *Bronze finishes*

Bronzature e graffiature con verniciatura opaca. L'unicità di un materiale come l'ottone rende possibile una realizzazione molto raffinata.

Bronze coating and texturing with matt varnish. The unique character of brass in an exceptionally refined interpretation.



AB
Bronzato
Antique bronze



OGH
Bronzo satinato opaco
Matt satin bronze



BSS
Bronzo scuro sfumato
Shaded dark bronze



BSO
Bronzo sabbiato opaco
Matt sandblasted bronze

Finiture anticate / *Antique finishes*

Finiture anticate, ottenute grazie a specifici processi di invecchiamento dell'ottone.

Antique finishes created with special aging processes for brass.



AF
Anticato
Antique finish



FAN
Ferro anticato
Antique iron

Finiture colorate / Coloured finishes

Toni inediti e originali per dare spazio alla creatività.

New, original tones to give room for creativity.



BNL
Bianco lucido
Bright white



OBN
Bianco
White



ONO
Nero
Black



OVE
Verde
Green



AGO
Giallo oliva
Yellow olive



AVP
Violetto pastello
Pastel violet



ABC
Blu colomba
Blue dove



ABT
Turchese
Turquoise



TAN
Antracite
Anthracite



ASV
Silver
Silver



ARO
Oro satinato
Satin gold



ABR
Bronzo
Bronze

resistenza al fuoco / fire resistance



Attestati di resistenza al fuoco EN 1634-2 ED. 2008

Test di resistenza al fuoco e al fumo per porte, finestre, serrature e componenti di ferramenta da costruzione.

I prodotti Dnd possono essere utilizzati per installazioni su porte e finestre che hanno ottenuto la certificazione EN 1634-2 e che hanno dimostrato di possedere la medesima resistenza al fuoco.

Attestation of fire resistance EN 1634-2 ED. 2008

Fire resistance and smoke control tests for door, shutter and openable window assemblies and elements of building hardware. The Dnd products can be used for installation on doors and openable windows of similar type that had been tested according to EN 1634-2, and have been shown to have at last the same fire resistance.

LAPI
LAPI LABORATORIO PREVENZIONE INCENDI S.p.A.
Sede Primaria: 19100 PRATO - Via della Quercia, 11
Telefono: +39 0574 515120 - Telex: 310 074 171 324
Sede Secondaria: 19001 CALZANZANO (PT) - Via Petrucci, 38
e-mail: lapi@laboratoriolapi.it
web site: www.laboratoriolapi.it

25 **APPROVED**
FIRE TESTING DIVISION

**ATTESTAZIONE DI RESISTENZA AL FUOCO
ATTESTATION OF FIRE RESISTANCE**

PRODUTTORE / PRODUCER:
DND MARTINELLI S.r.l.
Loc. Piani di Mura, 2
25070 Casto (BS)

STANDARD DI RIFERIMENTO / REFERENCE STANDARD:
EN 1634-2 Ed. 2008

Prove di resistenza al fuoco e di controllo della dispersione del fumo per porte, sistemi di chiusura, finestre apribili e loro componenti costruttivi - Parte 2: Prove di resistenza per componenti costruttivi
Fire resistance and smoke control tests for door, shutter and openable window assemblies and elements of building hardware
Part 2: Fire resistance characterisation test for elements of building hardware

Sulla base del test eseguito, la durata di resistenza al fuoco della maniglia:
On the base of the test performed, the fire resistance duration of the door handle:

ARTE', ARNONE, APPIA, ANDELA, ARTE', L'ART', BEVERLY, BERING, BOOLE, BRUXELLES, CIBIS, CHANGIÈ B, CLASSIC, CLASSIC 2, CLOE, DANIELA, DOLCE, DROP, DUE, EDRA, FEDORA, FIORE, FIORENTINA, FLUXE, FLUXE 2, FLUXO', GINKAGO, CHANGE, ARBITE' C-1918, COTTAGE, FLUXE, HAVANA, LINK, INTARE, ISABELLA, LADY, LATINA, LEVANTE, LINEAR, LIRICA, LORENA, LUCREZIA, LUXURY, MARCELINE, MOVIDA, NICE, PROJECT, SAK, S&S, S&S, SAFETY, SHIRT, SIRE, SIRE 2, TWIST, TWIST 2, ZEPPELIN

è / is

Integrità/Integrity: 68 minutes
Isolamento/Insulation: 68 minutes

I risultati di prova si riferiscono solo ai prodotti fabbricati e installati in conformità con il campione testato e descritto nel rapporto di prova N. 2493-2493.04/2014. I risultati possono essere utilizzati solo per l'installazione su porte e finestre apribili di tipo simile che sono stati testati secondo EN 1634-2, e hanno dimostrato di avere almeno la stessa resistenza al fuoco.
The test results relate only to products manufactured and installed in accordance with the specimen tested and described in Test Report N. 2493-2493.04/2014. The results can only be used for installation on door and openable windows of similar type that have been tested according to EN 1634-2, and have been shown to have at last the same fire resistance.

Prato, 09/01/2019

The Certification Manager
Dott. Massimo Borsini

The Director of the Laboratory
Dott. Luca Ermini

Il presente documento deve essere letto congiuntamente con i rapporti di prova, per la descrizione del prodotto e per ogni altro dettaglio. Questo documento non rappresenta né un'aggiornamento né un'estensione del prodotto né dichiarazione di conformità, che è esclusivamente sotto la responsabilità del Produttore e Richiedente.
This document has to be read in conjunction with the Test Report, for the description of the product and for every other detail. The document does not represent any update or completion of the product neither declaration of compliance, that is exclusively under the responsibility of the Manufacturer or Sponsor.

Il presente Rapporto di Prova non può essere riprodotto in forma parziale senza l'autorizzazione scritta di questo Laboratorio

LAPI
LAPI LABORATORIO PREVENZIONE INCENDI S.p.A.
Sede Primaria: 19100 PRATO - Via della Quercia, 11
Telefono: +39 0574 515120 - Telex: 310 074 171 324
Sede Secondaria: 19001 CALZANZANO (PT) - Via Petrucci, 38
e-mail: lapi@laboratoriolapi.it
web site: www.laboratoriolapi.it

25 **APPROVED**
FIRE TESTING DIVISION

**ATTESTAZIONE DI RESISTENZA AL FUOCO
ATTESTATION OF FIRE RESISTANCE**

PRODUTTORE / PRODUCER:
FNN MARTINELLI SPA
Loc. Piani di Mura, 2
25070 Casto (BS)

STANDARD DI RIFERIMENTO / REFERENCE STANDARD:
EN 1634-2 Ed. 2008

Prove di resistenza al fuoco e di controllo della dispersione del fumo per porte, sistemi di chiusura, finestre apribili e loro componenti costruttivi - Parte 2: Prove di resistenza per componenti costruttivi
Fire resistance and smoke control tests for door, shutter and openable window assemblies and elements of building hardware
Part 2: Fire resistance characterisation test for elements of building hardware

Sulla base del test eseguito, la durata di resistenza al fuoco della maniglia:
On the base of the test performed, the fire resistance duration of the door handle:

PREUDE, REALITY, THEIA, CLASSIC, AIRONE, LADY, KRISTINA, SAINNA, WING, REGGIANI, LATINA, HANDE', NOVA, B, LAURA, LORENA, BRUXELLES, DANIELA, POLO, ARTIK TAMA, GRIP TAMA, QUATTRO TAMA, STIK TAMA, CAROLA TAMA, SABINA TAMA, ELLE TAMA, NADA TAMA, NORA TAMA, VITA C, PROJECT, EDRA, LOGO-B, LOGO, ARDIA, VITA-B, EGO, GO, LUXURY, CASSIA, LINEAR, ART, FLUXO', DOLCE, SIRE, ESA, TWIST, JOY TAMA, CHANGE, ARBITE' C-1918, COTTAGE, FLUXE, HAVANA, LINK, MINIMA, MIL, LIRICA, LORENA, FAST, NOXIA, MOVIDA, NICE, SHIRT, SOFICH, TIPO, TEN, APPIA, VENICE, FEDORA, FIORENTINA, FIORE, WANDA, DIANA TICINA, S&S-20-46 ACCIAIO INOX.

è / is

Integrità/Integrity: 45 minutes
Isolamento/Insulation: 45 minutes

e della maniglia:
and of the door handle:

è / is

Integrità/Integrity: 45 minutes
Isolamento/Insulation: 45 minutes

I risultati di prova si riferiscono solo ai prodotti fabbricati e installati in conformità con il campione testato e descritto nel rapporto di prova N. 170-171-172/2008/2014. I risultati possono essere utilizzati solo per l'installazione su porte e finestre apribili di tipo simile che sono stati testati secondo EN 1634-2, e hanno dimostrato di avere almeno la stessa resistenza al fuoco.
The test results relate only to products manufactured and installed in accordance with the specimen tested and described in Test Report N. 170-171-172/2008/2014. The results can only be used for installation on door and openable windows of similar type that have been tested according to EN 1634-2, and have been shown to have at last the same fire resistance.

Prato, 30/04/2014

The Certification Manager
Dott. Massimo Borsini

The Director of the Laboratory
Dott. Luca Ermini

Il presente documento deve essere letto congiuntamente con i rapporti di prova, per la descrizione del prodotto e per ogni altro dettaglio. Questo documento non rappresenta né un'aggiornamento né un'estensione del prodotto né dichiarazione di conformità, che è esclusivamente sotto la responsabilità del Produttore e Richiedente.
This document has to be read in conjunction with the Test Report, for the description of the product and for every other detail. The document does not represent any update or completion of the product neither declaration of compliance, that is exclusively under the responsibility of the Manufacturer or Sponsor.

Il presente Rapporto di Prova non può essere riprodotto in forma parziale senza l'autorizzazione scritta di questo Laboratorio

– high-end

maniglie
alta gamma

door handles

Park Associati



Fondato a Milano nel 2000 da Filippo Pagliani e Michele Rossi, lo studio si occupa di progettazione architettonica, urbanistica, interior e product design.

L'approccio di Park Associati all'architettura è analitico, pragmatico e calibrato, forte della tradizione ma capace di generare nuovi codici linguistici grazie a un processo che combina ascolto, intuizione e sperimentazione. L'intuizione porta qualità e valore all'intervento progettuale.

La sperimentazione è alla base del pensiero di Park Associati e prende forma continuativa nel laboratorio Park Plus, una divisione interna dedicata allo studio di tecnologie, materiali e processi.

Founded in Milan in 2000 by Filippo Pagliani and Michele Rossi, the studio focuses its activity on architectural design, urban planning, interior and product design.

Park Associati's approach to architecture is analytical, pragmatic and tailored, strong in tradition but capable of generating new linguistic codes through a process that combines listening, intuition and experimentation. Intuition brings quality and value to projects.

Experimentation is at the core of Park Associati's thinking and takes shape continuously in the Park Plus laboratory, an internal unit dedicated to the study of technologies, materials and processes.

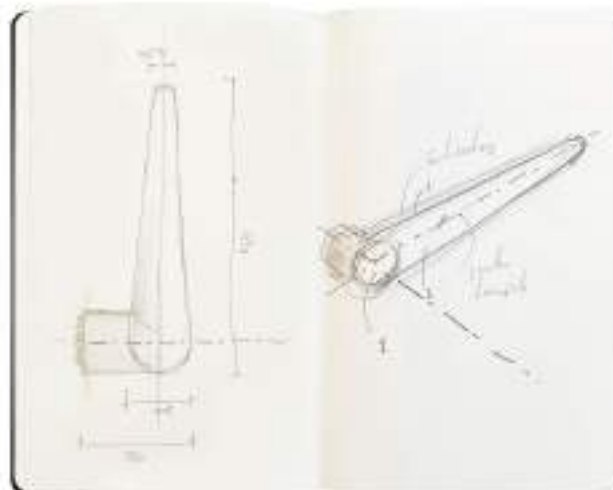

Leva
Disegni della maniglia di /
Handle sketches by
Park Associati

leva NEW



Espressione pura del concetto di leva, rimanda al mondo della meccanica e ai suoi strumenti. È caratterizzata, nella parte frontale, da un taglio netto sulla materia che si relaziona in armonia con la parte interna, arrotondata e accogliente.

A pure expression of the concept of lever, it evokes the world of mechanics and its tools. It is characterised on the front by a clean cut on the material that relates in harmony with the rounded and welcoming inner part.

leva **NEW**

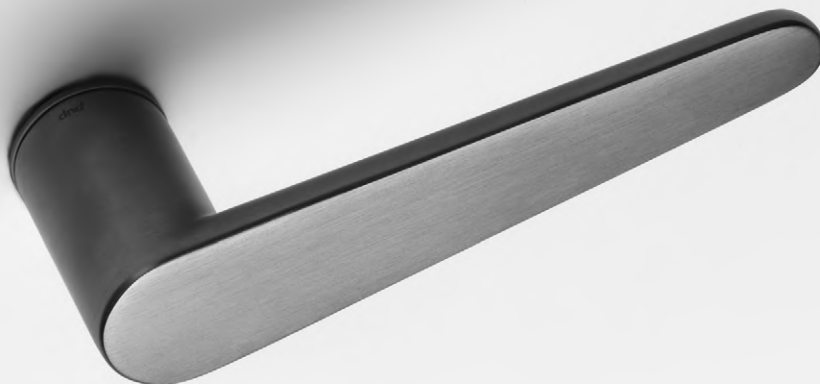

leva

design:
Park Associati

Ottone
Brass

made in italy

U LV80



PVD-SG | forte®
Oro antico satinato
Antique satin gold



PVD-SH | forte® new
Oro champagne satinato
Champagne satin gold



PVD-BB | forte® new
Bronzo lucido
Bright bronze



PVD-SB | forte® new
Bronzo satinato
Satin bronze



PVN | forte® new
Nickel lucido
Bright nickel



PGS | forte®
Grafite satinato
Satin graphite



OCS
Cromo satinato
Satin chrome



ONO
Nero
Black

coordinati per finestra
window complements

U LV22U



leva mirror



leva mirror

design:
Park Associati

Ottone
Brass

made in italy

U LM80



PVD-SBM | forte®
Oro antico satinato - Lucido
Antique satin gold - Bright



PVD-BBM | forte® new
Bronzo satinato - Lucido
Satin bronze - Bright



PGM | forte®
Grafite satinato - Lucido
Satin graphite - Bright



CCS
Cromo - Cromo satinato
Chrome - Satin chrome

coordinati per finestra
window complements

U LM22U



Gabriele & Oscar Buratti



Gabriele Buratti, architetto e professore di Architettura degli Interni alla Facoltà del Design del Politecnico di Milano (2003-2010), e Oscar Buratti, architetto, formano lo studio di architettura e design Buratti Architetti. Diverse sono le scale del progetto su cui lo studio dei due architetti lavora in maniera trasversale, passando dall'architettura di edifici e aree urbane a quella degli interni di spazi domestici e commerciali, dal design di mobili e oggetti all'allestimento di mostre e showroom, in un percorso professionale intenso e variegato.

Numerose sono le collaborazioni con importanti aziende del settore del mobile tra cui Acerbis, Alias, B&B Italia, Caleido, Flexform, Fontana Arte, Gallotti&Radice, Gervasoni, Lema, Living Divani, Paola Lenti, Moroso, Poltrona Frau, Porada, Porro, Roca, Tecno, Vondom.

Gabriele Buratti, architect and professor of Interior Design at the Faculty of Design of Politecnico di Milano (2003-2010), and Oscar Buratti, architect, form the architecture and design studio Buratti Architetti.

The two architects studio works on a variety of project scales, ranging from the architecture of buildings and urban areas to the interior design of domestic and commercial spaces, from furniture and object design to exhibition and showroom design, in an intense and varied professional career.

They collaborates with many important brands in the furniture design sector, including Acerbis, Alias, B&B Italia, Caleido, Flexform, Fontana Arte, Gallotti&Radice, Gervasoni, Lema, Living Divani, Paola Lenti, Moroso, Poltrona Frau, Porada, Porro, Roca, Tecno, Vondom.

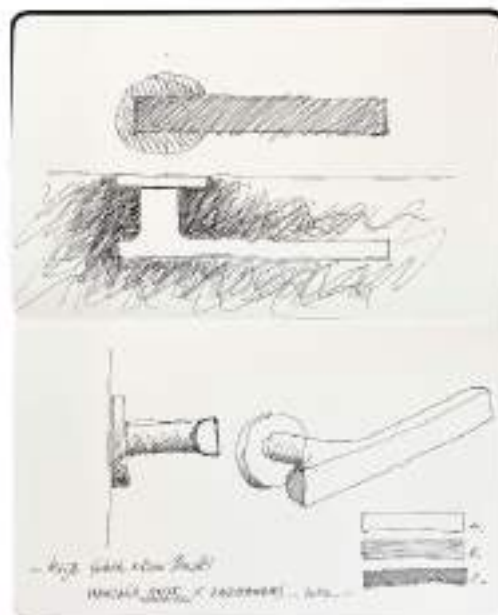

Anik
Disegni della maniglia di /
Handle sketches by
Gabriele & Oscar Buratti

anik NEW



L'attenta
combinazione di
un cilindro con un
mezzo cilindro genera
una maniglia solida
ed elegante, la cui
superficie frontale
si presta anche ad
accogliere lavorazioni
di diversa natura.
Anik viene proposta in
tre diverse versioni.

*The accurate
composition of a
cylinder with a half
cylinder generates a
strong and elegant
handle whose front
surface lends itself
to accommodating
different kinds of
processing.
Anik comes in three
different versions.*

anik NEW



anik

design:
Gabriele & Oscar Buratti

Ottone
Brass

made in italy

FINE AK40



PVD-BG | forte®
Oro antico lucido
Antique bright gold



PVD-SG | forte®
Oro antico satinato
Antique satin gold



PVD-SH | forte® new
Oro champagne satinato
Champagne satin gold



PVD-BB | forte® new
Bronzo lucido
Bright bronze



PVD-SB | forte® new
Bronzo satinato
Satin bronze



PVN | forte® new
Nickel lucido
Bright nickel



PGS | forte®
Grafite satinato
Satin graphite



BSO
Bronzo sabbiato opaco
Matt sandblasted bronze



OC new
Cromo lucido
Polished chrome



OCS
Cromo satinato
Satin chrome



ONO
Nero
Black

coordinati per finestra
window complements

VIS AK22V



U AK22U



AK20C



anik 02 NEW



anik 02

design:
Gabriele & Oscar Buratti

Ottone
Brass

made in italy

FINE AK41



PVD-BG | forte®
Oro antico lucido
Antique bright gold



PVD-SG | forte®
Oro antico satinato
Antique satin gold



PVD-SH | forte® new
Oro champagne satinato
Champagne satin gold



PVD-BB | forte® new
Bronzo lucido
Bright bronze



PVD-SB | forte® new
Bronzo satinato
Satin bronze



PVN | forte® new
Nickel lucido
Bright nickel



PGS | forte®
Grafite satinato
Satin graphite



BSO
Bronzo sabbato opaco
Matt sandblasted bronze



OC new
Cromo lucido
Polished chrome



OCS
Cromo satinato
Satin chrome



ONO
Nero
Black

coordinati per finestra
window complements

R AK25



AK23C



anik brilliant NEW



anik brilliant

design:
Gabriele & Oscar Buratti

Ottone
Brass

made in italy

AB40



PVD-BG | forte®
Oro antico lucido
Antique bright gold



PVD-SG | forte®
Oro antico satinato
Antique satin gold



PVD-SH | forte® new
Oro champagne satinato
Champagne satin gold



PVD-BB | forte® new
Bronzo lucido
Bright bronze



PVD-SB | forte® new
Bronzo satinato
Satin bronze



PVN | forte® new
Nickel lucido
Bright nickel



BSO
Bronzo sabbato opaco
Matt sandblasted bronze



OC new
Cromo lucido
Polished chrome



OCS new
Cromo satinato
Satin chrome



ONO
Nero
Black

coordinati per finestra
window complements

AB22V



AB22U



AB20C



anik brilliant 02 NEW



anik brilliant 02

design:
Gabriele & Oscar Buratti

Ottone
Brass

made in italy

FINE AB41



PVD-BG | forte®
Oro antico lucido
Antique bright gold



PVD-SG | forte®
Oro antico satinato
Antique satin gold



PVD-SH | forte® new
Oro champagne satinato
Champagne satin gold



PVD-BB | forte® new
Bronzo lucido
Bright bronze



PVD-SB | forte® new
Bronzo satinato
Satin bronze



PVN | forte® new
Nickel lucido
Bright nickel



BSO
Bronzo sabbato opaco
Matt sandblasted bronze



OC new
Cromo lucido
Polished chrome



OCS new
Cromo satinato
Satin chrome



ONO
Nero
Black

coordinati per finestra
window complements

R AB25



AB23C



anik line NEW



anik line

design:
Gabriele & Oscar Buratti

Ottone
Brass

made in italy

AE40



PVD-BG | forte®
Oro antico lucido
Antique bright gold



PVD-SG | forte®
Oro antico satinato
Antique satin gold



PVD-SH | forte® new
Oro champagne satinato
Champagne satin gold



PVD-BB | forte® new
Bronzo lucido
Bright bronze



PVD-SB | forte® new
Bronzo satinato
Satin bronze



PVN | forte® new
Nickel lucido
Bright nickel



BSO
Bronzo sabbato opaco
Matt sandblasted bronze



OC new
Cromo lucido
Polished chrome



OCS new
Cromo satinato
Satin chrome



ONO
Nero
Black

coordinati per finestra
window complements

AE22V



AE22U



AE20C



anik line 02 NEW

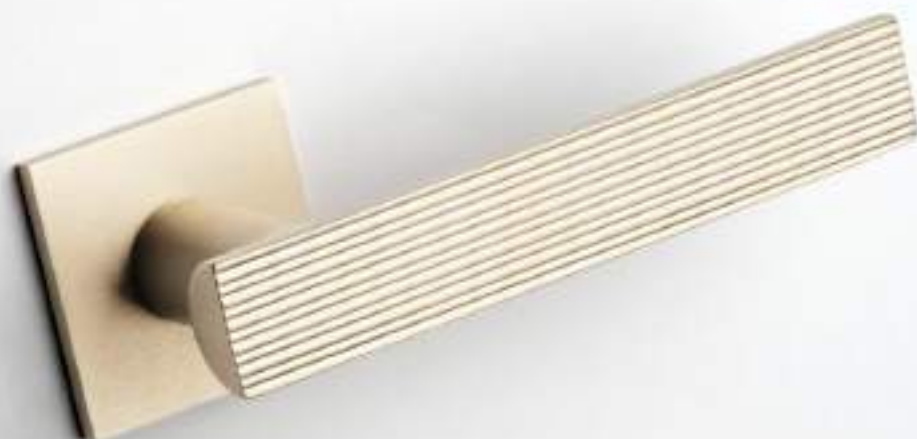

anik line 02

design:
Gabriele & Oscar Buratti

Ottone
Brass

made in italy

FINE AE41



PVD-BG | forte®
Oro antico lucido
Antique bright gold



PVD-SG | forte®
Oro antico satinato
Antique satin gold



PVD-SH | forte® new
Oro champagne satinato
Champagne satin gold



PVD-BB | forte® new
Bronzo lucido
Bright bronze



PVD-SB | forte® new
Bronzo satinato
Satin bronze



PVN | forte® new
Nickel lucido
Bright nickel



BSO
Bronzo sabbato opaco
Matt sandblasted bronze



OC new
Cromo lucido
Polished chrome



OCS new
Cromo satinato
Satin chrome



ONO
Nero
Black

coordinati per finestra
window complements

R AE25



AE23C



Elena Salmistraro



Product designer ed artista, vive e lavora a Milano. Si laurea in industrial design al Politecnico di Milano e nel 2009 fonda il proprio studio che si occupa di architettura e design, collaborando come product designer e illustratrice con molte aziende dell'industria creativa. È interessata allo sviluppo di un lavoro che si collochi a cavallo tra illustrazione, design e arti visive, mediante il quale intende definire un personale codice comunicativo. Tra le priorità delle sue creazioni, spiccano l'attenzione al dettaglio e la ricerca armonica delle forme, inseguite nell'antropomorfismo e nel primitivismo. Un eccesso di simboli grafici offre all'oggetto un'immagine stereoscopica trasportandolo in un territorio sospeso tra fantasia e realtà.

Product designer and artist, she lives and works in Milan. She graduated in industrial design at the Politecnico di Milano and in 2009 founded her studio that works in architecture and design, collaborating as a product designer and illustrator with many companies in the creative industry. She is interested in developing work that combines illustration, design and visual arts, through which she intends to define a personal code of communication. Among the priorities of her creations, emerge attention to detail and the harmonious search for forms pursued in anthropomorphism and primitivism. An excess of graphic symbols gives the object a stereoscopic image, transporting it into a territory suspended between fantasy and reality.



Crisalide e Dune
Disegni delle maniglie di /
Handles sketches by
Elena Salmistraro

crisalide NEW



Colori vivaci e segni primitivi per una maniglia che rimanda al variopinto mondo animale. Un metamorfismo e una leggerezza intrinseca che sono proprie del mondo delle farfalle e diventano tratto distintivo di una maniglia funzionale ma sempre pronta a librarsi in volo.

Vibrant colours and primitive signs come together in a handle that reflects the world of animals. It captures the essence of metamorphosis and inherent lightness, reminiscent of butterflies, becoming the distinctive feature of a functional handle that is always ready to take flight.

crisalide NEW



archiproducts
AWARDS
WINNER
2023

crisalide

design:
Elena Salmistraro

Alluminio + porcellana
Aluminium + porcelain

made in italy

CS40



ARO + PSD

Oro satinato + porcellana lucida decorata

Satin gold + decorated glossy porcelain



AVP + PSD

Violetto pastello + porcellana lucida decorata

Pastel violet + decorated glossy porcelain



ARO + PSW

Oro satinato + porcellana lucida bianca

Satin gold + white glossy porcelain



ABN + PSD

Bianco + porcellana lucida decorata

White + decorated glossy porcelain



ABC + PSD

Blu colomba + porcellana lucida decorata

Blue dove + decorated glossy porcelain



ANE + PSW

Nero + porcellana lucida bianca

Black + white glossy porcelain



ANE + PSD

Nero + porcellana lucida decorata

Black + decorated glossy porcelain

coordinati per finestra
window complements

CS22V



CS22U



CS70
pomolino per mobile
furniture knob



CS71
pomolino per mobile
furniture knob



CS72
appendino
hanger



crisalide mini NEW



crisalide mini

design:
Elena Salmistraro

Alluminio + porcellana
Aluminium + porcelain

made in italy

FINE CM40



ARO + PSD

Oro satinato + porcellana lucida decorata

Satin gold + decorated glossy porcelain



AVP + PSD

Violetto pastello + porcellana lucida decorata

Pastel violet + decorated glossy porcelain



ARO + PSW

Oro satinato + porcellana lucida bianca

Satin gold + white glossy porcelain



ABN + PSD

Bianco + porcellana lucida decorata

White + decorated glossy porcelain



ABC + PSD

Blu colomba + porcellana lucida decorata

Blue dove + decorated glossy porcelain



ANE + PSW

Nero + porcellana lucida bianca

Black + white glossy porcelain



ANE + PSD

Nero + porcellana lucida decorata

Black + decorated glossy porcelain

coordinati per finestra
window complements

VIS CM22V



U CM22U



dune NEW
white



dune

design:
Elena Salmistraro

made in italy

Ottone + porcellana lucida
bianco sabbia
*Brass + sand-white glossy
porcelain*

FINE DN40



PVD-BG | forte® + PSB
Oro antico lucido
Antique bright gold



PVD-SG | forte® + PSB
Oro antico satinato
Antique satin gold



PVD-SCB | forte® + PSB
Rame satinato
Satin copper



OBN + PSB new
Bianco
White

U



ONO + PSB
Nero
Black

coordinati per finestra
window complements

VS DN22V



U DN22U



DN70
pomolino per mobile
furniture knob



dune NEW
green



dune

design:
Elena Salmistraro

made in italy

Ottone + porcellana lucida
verde menta

*Brass + mint-green glossy
porcelain*

DN40



PVD-BG | forte® + PSV

Oro antico lucido
Antique bright gold



PVD-SG | forte® + PSV

Oro antico satinato
Antique satin gold



PVD-SCB | forte® + PSV

Rame satinato
Satin copper



OBN + PSV new

Bianco
White

U



ONO + PSV

Nero
Black

coordinati per finestra
window complements

DN22V



DN22U



DN70
pomolino per mobile
furniture knob



dune NEW

pink



dune

design:
Elena Salmistraro

made in italy

Ottone + porcellana lucida
rosa nuvola

*Brass + cloud-pink glossy
porcelain*

DN40



PVD-BG | forte® + PSR

Oro antico lucido
Antique bright gold



PVD-SG | forte® + PSR

Oro antico satinato
Antique satin gold



PVD-SCB | forte® + PSR

Rame satinato
Satin copper



OBN + PSR new

Bianco
White

U



ONO + PSR

Nero
Black

coordinati per finestra
window complements

DN22V

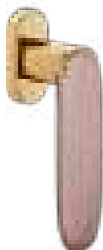

DN22U



DN70
pomolino per mobile
furniture knob



Holscher Design



Studio di progettazione multidisciplinare con base a Copenhagen, in Danimarca, è attivo dal 1990 e si colloca tra le più riconosciute e premiate agenzie di progettazione della Scandinavia. Holscher Design è diretto da un team di cinque soci, è fortemente radicato nella tradizione dei Paesi del Nord e sviluppa progetti a livello internazionale in diversi ambiti, tra cui illuminazione, sanitari, componenti per l'edilizia, design urbano. Tra le collaborazioni, Geberit, Flos, JCDecaux, Philips, Lamy.

A multidisciplinary design firm based in Copenhagen, Denmark, Holscher Design has been active since 1990 and is amongst the most well-established and award-winning design agencies in Scandinavia. The studio is headed up by a team of five partners, with deep roots in the tradition of the Nordic countries, and develops international projects spanning various fields, including lighting, sanitaryware, construction components and urban design. Its many collaborations include Geberit, Flos, JCDecaux, Philips and Lamy.

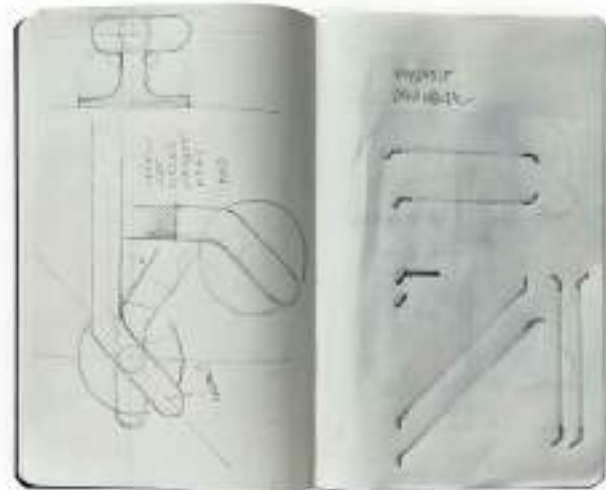

Pod
Disegni della maniglia di /
Handle sketches by
Holscher Design

pod



Una serie realizzata con una lavorazione dedicata e originale: un tondino di materiale viene tornito alle estremità e opportunamente inclinato di 45 gradi, per generare un gesto dinamico ed equilibrato sull'orizzontalità della leva.

A series created with a dedicated and original manufacturing process: a rod of material is turned at each end and carefully bent at a 45 degrees angle, making for a dynamic and balanced gesture on the horizontal bar of the lever.

pod



archiproducts
DESIGN AWARDS
2022
WINNER

pod

design:
Holscher Design

Ottone
Brass

made in italy

FINE PD40



PVD-BG | forte®
Oro antico lucido
Antique bright gold



PVD-SG | forte®
Oro antico satinato
Antique satin gold



PVD-BB | forte® new
Bronzo lucido
Bright bronze



PVD-SB | forte® new
Bronzo satinato
Satin bronze



PGS | forte®
Grafite satinato
Satin graphite



OC
Cromo lucido
Polished chrome



OCS
Cromo satinato
Satin chrome



ONO
Nero
Black

coordinati
complements



PD27
maniglione
pull handle

Alfonso Femia



Originario di Taurianova (RC), vive tra Genova, Milano e Parigi. Laureato presso la Facoltà di Architettura dell'Università di Genova nel 1992, è iscritto all'Ordine degli Architetti di Genova, dell'Île-de-France e della Svizzera. Ha insegnato Progettazione Architettonica alla Kent State University di Firenze, alla Facoltà di Architettura di Ferrara e a quella di Genova. Fondatore di 5+1 nel 1995, crea 5+1AA nel 2005 e 5+1AA Parigi nel 2007. Tra i suoi progetti, la nuova sede BNP Paribas a Roma, i Docks di Marsiglia, le OGR di Torino.

Born in Taurianova (RC), he lives between Genoa, Milan and Paris. With a degree from the School of Architecture of the University of Genoa in 1992, he is a member of the Architects Associations of Genoa, Île-de-France and Switzerland. He has taught Architectural Design at Kent State University in Florence, and the Schools of Architecture of Ferrara and Genoa. He was a founder of 5+1 in 1995, and created 5+1AA in 2005 and 5+1AA Paris in 2007. His projects include the new BNP Paribas headquarters in Rome, the Docks of Marseille, the OGR in Turin.



(IN) finito
Disegni della maniglia di /
Handle sketches by
Alfonso Femia

(IN)finito



Come un filo bidimensionale che arriva dai bordi della porta, disegna la maniglia e poi continua il suo viaggio, ora verso l'altro lato, ora verso l'alto, ora nell'altra direzione.

Like a two-dimensional line that arrives from the edges of the door and draws the handle before continuing on its way, towards the other side, upward, in the opposite direction.

(IN)finito



Selezionato ADI DESIGN 2019
Selected for ADI DESIGN 2019

(IN)finito

design:
Alfonso Femia

Ottone
Brass

made in italy

IF10/L



OLV
Lucido
Polished



SO
Sabiato opaco
Matt sandblasted



AB
Bronzato
Antique bronze



OC new
Cromo lucido
Polished chrome



OCS
Cromo satinato
Satin chrome



ONO
Nero
Black

coordinati per finestra
window complements

R IF25



IF31
maniglione
pull handle



(IN)finito



(IN)finito

design:
Alfonso Femia

Ottone
Brass

made in italy

IF10



PVD-BB | forte® new
Bronzo lucido
Bright bronze



PVD-SB | forte® new
Bronzo satinato
Satin bronze



PGS | forte® new
Grafite satinato
Satin graphite



OLV
Lucido
Polished



SO
Sabbato opaco
Matt sandblasted



AB
Bronzato
Antique bronze



OC new
Cromo lucido
Polished chrome



OCS
Cromo satinato
Satin chrome



ONO
Nero
Black

coordinati per finestra
window complements

R IF25



IF29
maniglione
pull handle



(IN)finito



(IN)finito

design:
Alfonso Femia

Ottone
Brass

made in italy

IF01



PVD-BB | forte® new
Bronzo lucido
Bright bronze



PVD-SB | forte® new
Bronzo satinato
Satin bronze



PGS | forte® new
Grafite satinato
Satin graphite



OLV
Lucido
Polished



SO
Sabbato opaco
Matt sandblasted



AB
Bronzato
Antique bronze

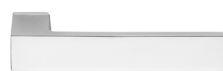

OC new
Cromo lucido
Polished chrome

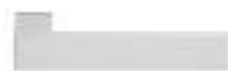

OCS
Cromo satinato
Satin chrome



ONO
Nero
Black

coordinati per finestra
window complements

R IF25



ED26C



IF27
maniglione
pull handle



(IN)finito



(IN)finito

design:
Alfonso Femia

Ottone
Brass

made in italy

IF11



PVD-BB | forte® new
Bronzo lucido
Bright bronze



PVD-SB | forte® new
Bronzo satinato
Satin bronze



PGS | forte® new
Grafite satinato
Satin graphite



OLV
Lucido
Polished



SO
Sabbiato opaco
Matt sandblasted



AB
Bronzato
Antique bronze



OC new
Cromo lucido
Polished chrome



OCS
Cromo satinato
Satin chrome



ONO
Nero
Black

coordinati per finestra
window complements

R IF25



ED26C



(IN)finito

design:
Alfonso Femia

Ottone
Brass

made in italy

IF40



PVD-BB | forte® new
Bronzo lucido
Bright bronze



PVD-SB | forte® new
Bronzo satinato
Satin bronze



PGS | forte® new
Grafite satinato
Satin graphite



OLV
Lucido
Polished



SO
Sabbiato opaco
Matt sandblasted



AB
Bronzato
Antique bronze



OC new
Cromo lucido
Polished chrome



OCS
Cromo satinato
Satin chrome



ONO
Nero
Black

(IN)finito

design:
Alfonso Femia

Ottone
Brass

made in italy

IF41



PVD-BB | forte® new
Bronzo lucido
Bright bronze



PVD-SB | forte® new
Bronzo satinato
Satin bronze



PGS | forte® new
Grafite satinato
Satin graphite



OLV
Lucido
Polished



SO
Sabbato opaco
Matt sandblasted



AB
Bronzato
Antique bronze



OC new
Cromo lucido
Polished chrome



OCS
Cromo satinato
Satin chrome



ONO
Nero
Black

coordinati per finestra
window complements

IF25



ED26C



IF27
maniglione
pull handle



Marco Pisati



Designer fiorentino, architetto di formazione, è affascinato dai nuovi materiali e dalle nuove tecnologie. Sperimenta le sue idee nei settori più diversi, progettando per diverse aziende: ASI (Agenzia Spaziale Italiana), Emilio Pucci, Antonio Lupi, Cordivari, Cristina Rubinetterie, Gattoni Rubinetterie, Treemme Rubinetterie, Glass Design, K8 Radiatori. Diversi i premi e i riconoscimenti ottenuti dai suoi prodotti: Red Dot Design Award, German Design Award, Archiproducts Design Award, ADI Ceramics & Bathroom Design Award.

A designer from Florence, trained as an architect, fascinated by new materials and technologies. He experiments with ideas in a wide range of sectors, designing for different companies: ASI (Italian Space Agency), Emilio Pucci, Antonio Lupi, Cordivari, Cristina Rubinetterie, Gattoni Rubinetterie, Treemme Rubinetterie, Glass Design, K8 Radiatori. He has been awarded many design awards for his projects: Red Dot Design Award, German Design Award, Archiproducts Design Award, ADI Ceramics & Bathroom Design Award.

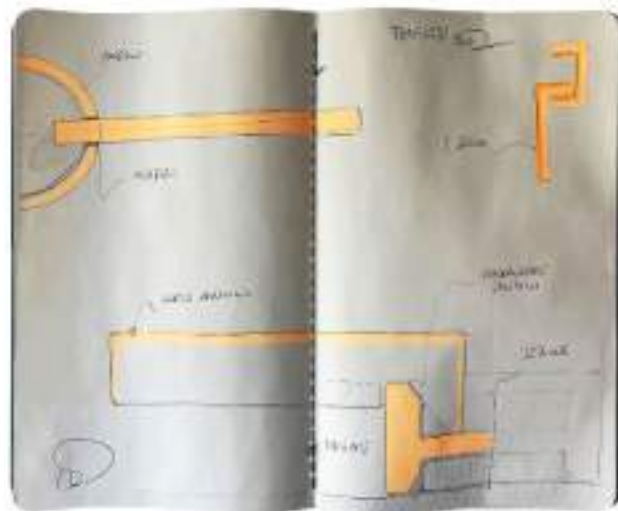

Timeless
Disegni della maniglia di /
Handle sketches by
Marco Pisati

timeless

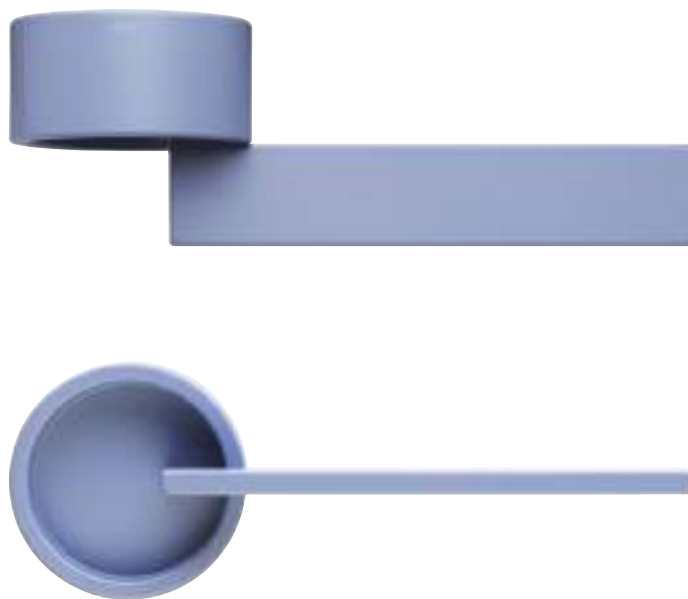

Due segni grafici essenziali, una linea e un cerchio che si intersecano in maniera centrale e simmetrica.

Two essential graphic signs, a line and a circle that intersect in a central and symmetrical way.

timeless



timeless

design:
Marco Pisati

Alluminio
Aluminium

made in italy

TL01



ARO
Oro satinato
Satin gold



ABR
Bronzo
Bronze



ASV
Silver
Silver



ABN
Bianco
White



AGO
Giallo oliva
Yellow olive



AVP
Violetto pastello
Pastel violet



ABC
Blu colomba
Blue dove



ABT
Turchese
Turquoise



ANE
Nero
Black

coordinati per finestra
window complements

TL22U



TL39
pomolo
knob



TL70
pomolino per mobile
furniture knob



isabella



Un cilindro e lievi
modanature, tra
forme classiche e
volumi moderni.

*A cylinder and
slight moldings,
between classical
forms and modern
volumes.*

isabella

design:
Marco Pisati

Ottone
Brass

made in italy

FINE IS40



PVD-BG | forte®
Oro antico lucido
Antique bright gold



PVD-SG | forte®
Oro antico satinato
Antique satin gold



PVD-SH | forte® new
Oro champagne satinato
Champagne satin gold



PVD-BB | forte® new
Bronzo lucido
Bright bronze



PVD-SB | forte® new
Bronzo satinato
Satin bronze



PVN | forte® new
Nickel lucido
Bright nickel



PGS | forte®
Grafite satinato
Satin graphite



OGH
Bronzo satinato opaco
Matt satin bronze



OC
Cromo lucido
Polished chrome



OCS new
Cromo satinato
Satin chrome

coordinati per finestra
window complements

VIS IS22V



U IS22U



IS20C



lucrezia



Rimandi rinascimentali nel bel modellato dello stelo, a cui si aggiunge il disegno dell'impugnatura: una forma rettangolare alleggerita da un'elegante modanatura a caratterizzare il bordo.

Renaissance references in the fine shaping of the stem, joined by the design of the grip: a rectangular form lightened by elegant shaped borders.

lucrezia

design:
Marco Pisati

Ottone
Brass

made in italy

LT40



PVD-BG | forte®
Oro antico lucido
Antique bright gold



PVD-SG | forte®
Oro antico satinato
Antique satin gold



PVN | forte® new
Nickel lucido
Bright nickel



PGS | forte®
Grafite satinato
Satin graphite



OGH
Bronzo satinato opaco
Matt satin bronze



OC new
Cromo lucido
Polished chrome



OCS new
Cromo satinato
Satin chrome

coordinati per finestra *window complements*

LT30V



LT35
pomolo
knob



LT27
maniglione
pull handle



LT70
pomolino per mobile
furniture knob



LT80
accessori per mobili
furniture accessories



lucrezia 02



Lucrezia 02

design:
Marco Pisati

Ottone
Brass

made in italy

FINE LT41



PVD-BG | forte®
Oro antico lucido
Antique bright gold



PVD-SG | forte®
Oro antico satinato
Antique satin gold



PVN | forte® new
Nickel lucido
Bright nickel



PGS | forte®
Grafite satinato
Satin graphite



OGH
Bronzo satinato opaco
Matt satin bronze



OC new
Cromo lucido
Polished chrome



OCS new
Cromo satinato
Satin chrome

coordinati per finestra
window complements

R LT31



LT10
maniglia su placca
handle on plate



LT35
pomolo
knob



LT27
maniglione
pull handle



eleonora

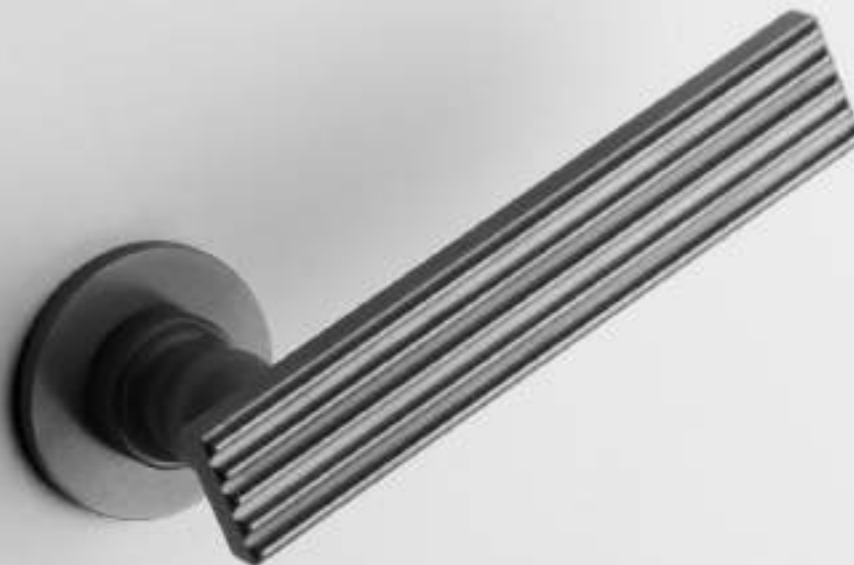

Sottili scanalature per l'impugnatura, in omaggio allo stile ionico; e un modellato morbido ma rigoroso per lo stelo: una maniglia che guarda agli stili della storia, in equilibrio tra antica Grecia e Rinascimento.

Subtle grooves in the handle, redolent of the Ionic style, along with a soft yet rigorous shape for the stem: a handle that draws upon styles from throughout history, carefully balanced between Ancient Greece and the Renaissance.

eleonora

design:
Marco Pisati

Ottone
Brass

made in italy

FINE EL40



PVD-BG | forte®
Oro antico lucido
Antique bright gold



PVD-SG | forte®
Oro antico satinato
Antique satin gold



PVN | forte® new
Nickel lucido
Bright nickel



PGS | forte®
Grafite satinato
Satin graphite



OGH
Bronzo satinato opaco
Matt satin bronze



OC new
Cromo lucido
Polished chrome



OCS new
Cromo satinato
Satin chrome

coordinati per finestra
window complements

VIS EL22V



U EL22U



EL29
maniglione
pull handle



EL31
maniglione
pull handle

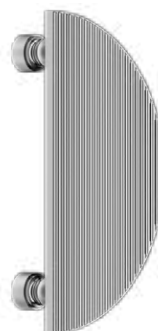

eleonora 02



eleonora 02

design:
Marco Pisati

Ottone
Brass

made in italy

FINE EL41



PVD-BG | forte®
Oro antico lucido
Antique bright gold



PVD-SG | forte®
Oro antico satinato
Antique satin gold



PVN | forte® new
Nickel lucido
Bright nickel



PGS | forte®
Grafite satinato
Satin graphite



OGH
Bronzo satinato opaco
Matt satin bronze



OC new
Cromo lucido
Polished chrome

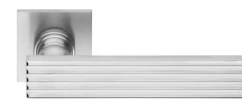

OCS new
Cromo satinato
Satin chrome

coordinati per finestra
window complements

R EL25



EL10
maniglia su placca
handle on plate



EL27
maniglione
pull handle

Luca Nichetto



Designer originario di Venezia, è attivo a livello internazionale ed è specializzato in design industriale, design del prodotto e consulenza. I suoi due studi si trovano a Venezia – dal 2006 – e in Svezia, a Stoccolma – dal 2011. Ha ricevuto numerosi premi internazionali per i suoi progetti, che spaziano tra prodotti, mobili e accessori, oltre a integrare architettura e design espositivo. Tra i marchi dei suoi progetti Arflex, Cassina, De La Espada, Foscarini, Hermès, Molteni & C, Tubes, Venini, Wittmann.

Designer originally from Venice, he works on an international basis and specialises in industrial design, product design and design consultancy. His two studios are based in Italy in Venice – from 2006 – and in Sweden – from 2011. He has been awarded numerous international design awards for his projects, which range across products, furniture and accessories, as well as incorporating architecture and exhibition design. Among the brands of his projects, Arflex, Cassina, De La Espada, Foscarini, Hermès, Molteni & C, Tubes, Venini, Wittmann.

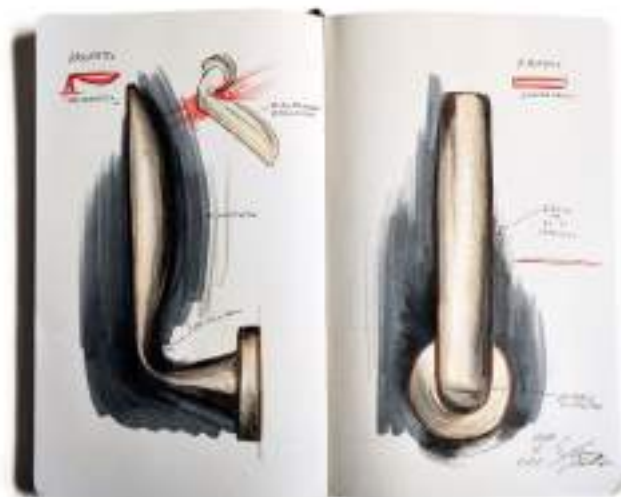

Viva!
Disegni della maniglia di /
Handle sketches by
Luca Nichetto

viva!



Una maniglia che nasce dalla fusione dei fondamentali aspetti ergonomici con la sobrietà dell'impatto visivo. Viva! presenta un aspetto diverso a seconda del punto di osservazione, con tratti lineari o morbidi e sinuosi a caratterizzarla.

A handle based on the fusion of fundamental ergonomic aspects with understated visual impact. Viva! looks different from various vantage points, with linear or soft, sinuous features.

viva!



viva!

design:
Luca Nichetto

Ottone
Brass

made in italy

FINE VV40



PVD-BG | forte®
Oro antico lucido
Antique bright gold



PVD-SG | forte®
Oro antico satinato
Antique satin gold



PVD-SCB | forte®
Rame satinato
Satin copper



PVN | forte® new
Nickel lucido
Bright nickel



PGS | forte®
Grafite satinato
Satin graphite



OGH
Bronzo satinato opaco
Matt satin bronze



OC new
Cromo lucido
Polished chrome



OCS
Cromo satinato
Satin chrome

coordinati per finestra
window complements

VS VV22V



U VV22U



Giulio Iacchetti



Vive e lavora a Milano, dove si occupa di industrial design dal 1992. Tra le aziende con cui collabora: Alessi, Artemide, Bvlgari, Coop, Danese Milano, Foscarini, Nava, Magis.

È direttore artistico di Abet Laminati, Dnd, Montbook, Ebanisteria Meccanica.

Da sempre attento all'evoluzione del rapporto tra realtà artigiana e design, nel 2012 fonda il marchio Internoitaliano.

Tra i suoi caratteri distintivi ci sono la ricerca e la definizione di nuove tipologie oggettuali.

Nel 2009 la Triennale di Milano ha ospitato una sua mostra personale intitolata "Giulio Iacchetti. Oggetti disobbedienti". È stato premiato con due premi ADI Compasso d'Oro (2001, posata "Moscardino"; 2014, tombini serie "Sfera") e ha ricevuto diversi riconoscimenti internazionali.

He lives and works in Milan, where he has been involved in industrial design since 1992. Among the companies he collaborates with are: Alessi, Artemide, Bvlgari, Coop, Danese Milano, Foscarini, Nava, Magis.

He is the artistic director of Abet Laminati, Dnd, Montbook, Ebanisteria Meccanica.

Always attentive to the evolution of the relationship between craftsmanship and design, he founded the brand Internoitaliano in 2012.

His distinctive features include research and the definition of new object typologies.

In 2009, the Triennale di Milano hosted a solo exhibition of his work entitled "Giulio Iacchetti. Oggetti disobbedienti". He has been awarded two ADI Compasso d'Oro awards (2001, "Moscardino" cutlery; 2014, "Sfera" series manhole covers) and has received several international awards.

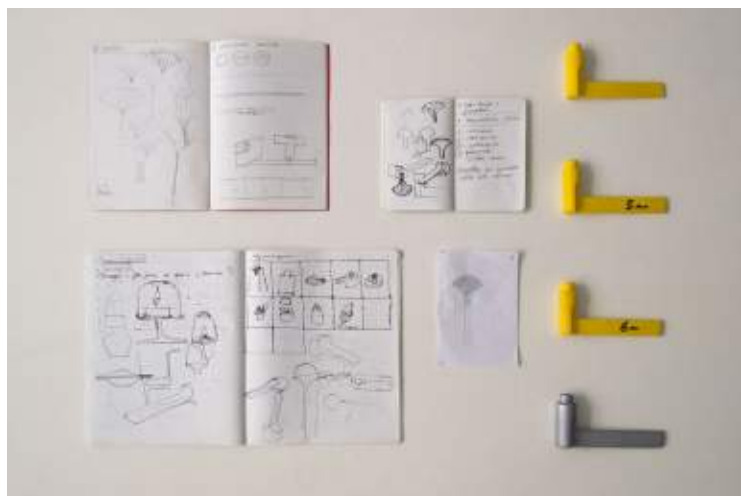

Ginkgo

Disegni della maniglia di /
Handle sketches by
Giulio Iacchetti

ginkgo



Una forma di ispirazione naturale, quale la bellissima foglia del Ginkgo, si fa struttura e decoro per una maniglia che nasce in due diverse versioni.

A form based on nature, the special, unique shape of a Ginkgo leaf, becomes the structure and decoration of a handle that is made in two different versions.

ginkgo



**Good Design Awards
2017**

ginkgo

design:
Giulio lacchetti

Ottone
Brass

made in italy

FINE GK40



PVD-BG | forte®
Oro antico lucido
Antique bright gold



PVD-SG | forte®
Oro antico satinato
Antique satin gold



PVD-SH | forte® new
Oro champagne satinato
Champagne satin gold



PVD-BB | forte® new
Bronzo lucido
Bright bronze



PVD-SB | forte® new
Bronzo satinato
Satin bronze



PVN | forte® new
Nickel lucido
Bright nickel



PGS | forte®
Grafite satinato
Satin graphite



OC
Cromo lucido
Polished chrome



OCS
Cromo satinato
Satin chrome



ONO
Nero
Black

coordinati per finestra
window complements

VS GK22V



U GK22U



GK20C



GK27
maniglione
pull handle



ginkgo biloba

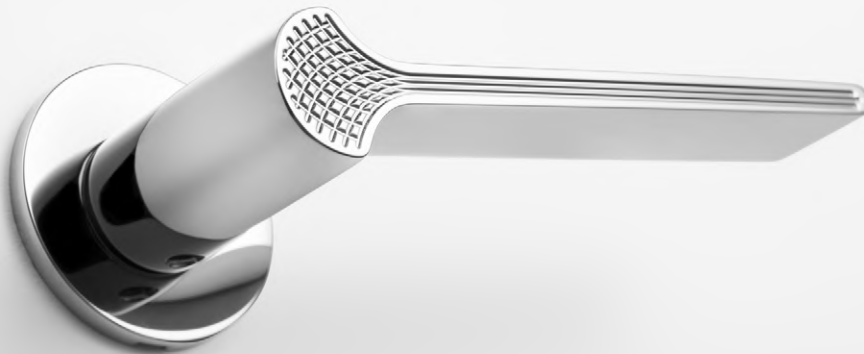

Good Design Awards
2017



Ginkgo Biloba, la versione della maniglia Ginkgo con l'incisione in superficie, è un ulteriore rimando metaforico alle venature della foglia.

Ginkgo Biloba, the version of the Ginkgo handle with the decorative surface engraving, is a further metaphorical reminder of the veins of the leaf.

ginkgo biloba

design:
Giulio lacchetti

Ottone
Brass

made in italy

FINE GB40



PVD-BG | forte®
Oro antico lucido
Antique bright gold



PVD-SG | forte®
Oro antico satinato
Antique satin gold



PVD-SH | forte® new
Oro champagne satinato
Champagne satin gold



PVD-BB | forte® new
Bronzo lucido
Bright bronze



PVD-SB | forte® new
Bronzo satinato
Satin bronze



PVN | forte® new
Nickel lucido
Bright nickel



PGS | forte®
Grafite satinato
Satin graphite



OC
Cromo lucido
Polished chrome



OCS
Cromo satinato
Satin chrome



ONO
Nero
Black

coordinati per finestra
window complements

VS GB22V



U GB22U



GB20C



GB27
maniglione
pull handle



freely



freely

design:
Giulio lacchetti

Alluminio
Aluminium

made in italy

FR01



ACS
Cromo satinato
Satin chrome



AAN
Antracite
Anthracite



ANE
Nero
Black



Odo Fioravanti



Dal 2003, con base a Milano, lavora come industrial designer sperimentando anche la grafica e l'exhibition design. I suoi oggetti sono stati esposti in molte mostre internazionali e nel 2010 il Design Museum della Triennale di Milano ha dedicato al suo lavoro la personale "Industrious Design". Nel 2011 ha vinto il Compasso d'Oro ADI con la sedia in legno Frida di Pedrali. Tra i suoi clienti, Alpi, Flou, Fontana Arte, Foscarini, Land Rover, Maison 203, Normann Copenhagen, Pedrali, Toshiba, Vibram, Victorinox.

Since 2003, based in Milan, he has been working as an industrial designer, while experimenting also with graphic and exhibition design. His objects have been shown in many international exhibitions and in 2010 the Design Museum of the Triennale di Milano dedicated to his work the solo exhibition "Industrious Design". In 2011 he won the Compasso d'Oro ADI award with the Frida wooden chair by Pedrali. Among his clients, Alpi, Flou, Fontana Arte, Foscarini, Land Rover, Maison 203, Normann Copenhagen, Pedrali, Toshiba, Vibram, Victorinox.

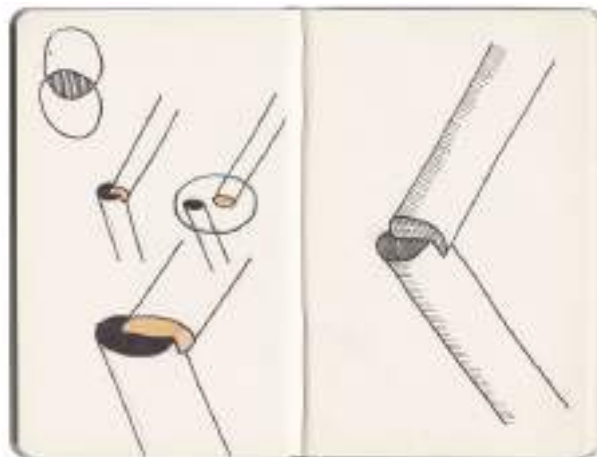

Boole
Disegni della maniglia di /
Handle sketches by
Odo Fioravanti

boole



Due cilindri si incontrano e si intersecano con il leggero slittamento di uno rispetto all'altro, nella condivisione di una piccola, comune porzione di materia.

Two cylinders meet and intersect with a slight shift, sharing a small portion of material.

boole



boole

design:
Odo Fioravanti

Ottone
Brass

made in italy

FINE BE40



PVD-SG | forte®
Oro antico satinato
Antique satin gold



PVD-SB | forte® new
Bronzo satinato
Satin bronze



PVX | forte®
Inox satinato
Satin steel



PGS | forte®
Grafite satinato
Satin graphite



OCS
Cromo satinato
Satin chrome



U **ONO**
Nero
Black

coordinati per finestra
window complements

VS BE22V



U BE22U



safety



safety

design:
Enrico Martini

Ottone
Brass

made in italy

SA40



PVD-SG | forte®
Oro antico satinato
Antique satin gold



PVD-SCB | forte®
Rame satinato
Satin copper



PVX | forte®
Inox satinato
Satin steel



PGS | forte®
Grafite satinato
Satin graphite



OCS
Cromo satinato
Satin chrome



ONO
Nero
Black

coordinati per finestra
window complements

SA22V



Maurizio Varratta



Nato a Genova, si laurea in architettura nel 1981 e dal 1983 al 1999 lavora con lo studio Renzo Piano Building Workshop. Nel 1999 apre il suo studio e comincia a partecipare a numerosi concorsi internazionali, mentre svolge l'attività di professore in diverse università (Politecnico di Torino, La Sapienza di Roma, Carleton University di Ottawa). I lavori dello studio spaziano dalla progettazione architettonica generale al design e allo space planning, con l'applicazione dei principi della sostenibilità ambientale e della qualità degli spazi.

Born in Genoa, he graduated in architecture in 1981 and worked with the Renzo Piano Building Workshop from 1983 to 1999. In 1999 he opened his own firm and began to participate in numerous international competitions, while working as a professor in various universities (Politecnico di Torino, La Sapienza di Roma, Carleton University in Ottawa). The studio's work ranges from architectural design to industrial design and space planning, applying the principles of environmental sustainability and quality of space.

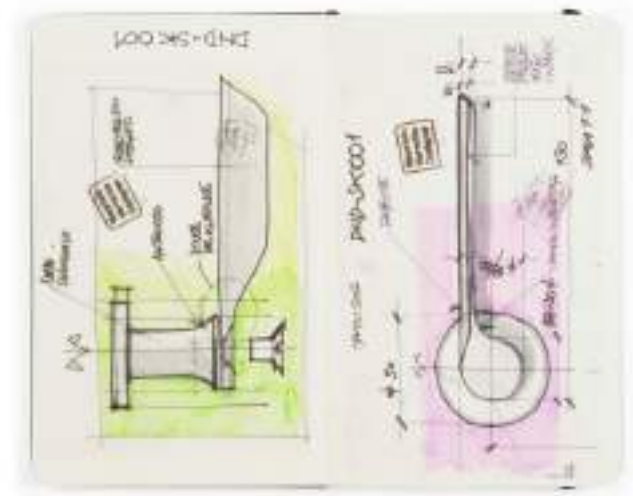

Levante
Disegni della maniglia di /
Handle sketches by
Maurizio Varratta

levante



L'essenzialità di una
forma asciutta e
semplice, caratterizza
un oggetto il cui
disegno si identifica
con la sua funzione.

*The essence of a
terse, simple form,
an object whose
design would be
identified with its
function.*

levante



levante

design:
Maurizio Varratta

Ottone
Brass

made in italy

FINE LE40



PVD-SG | forte®
Oro antico satinato
Antique satin gold



PVD-SCB | forte®
Rame satinato
Satin copper



PVX | forte®
Inox satinato
Satin steel



PGS | forte®
Grafite satinato
Satin graphite



OCS
Cromo satinato
Satin chrome



U **ONO new**
Nero
Black

coordinati per finestra
window complements

VIS LE22V



U LE22U



Stefano Boeri Architetti



Con sede a Milano e uffici a Shanghai (dal 2014) e Tirana (dal 2015), Stefano Boeri Architetti si dedica dal 1993 alla progettazione e alla ricerca, principalmente in ambito architettonico e urbanistico, ma anche culturale, del design e dell'interior design. Lo studio ha sviluppato progetti architettonici e di rigenerazione in luoghi complessi e in più continenti. Tra i progetti costruiti più noti, il Bosco Verticale di Milano, la Villa Méditerranée a Marsiglia e la Casa del Mare sull'isola de La Maddalena, in Sardegna.

Based in Milan, with offices in Shanghai (since 2014) and Tirana (since 2015), Stefano Boeri Architetti has focused since 1993 on design and research, mostly in the fields of architecture and urban planning, but also on culture and interior design. The studio has developed projects of architecture and urban regeneration in complex locations and on multiple continents. Outstanding constructed works include the Bosco Verticale in Milan, the Villa Méditerranée in Marseille and the Casa del Mare on the island of La Maddalena, Sardinia.



DUE
Disegni della maniglia di /
Handle sketches by
Stefano Boeri Architetti

DUE



Una soluzione
dalla forza plastica
essenziale:
la sua figura è resa
primigenia attraverso
la trasformazione
dei due tradizionali
elementi funzionali,
l'impugnatura e
la rosetta, in una
coppia di sottili
parallelepipedi
perfettamente
uguali tra loro.

*A solution of essential
sculptural force:
the figure becomes
primeval through
the transformation
of the two traditional
functional elements,
the grip and the
plate, into a pair
of slender
parallelepipeds,
perfectly equal.*

DUE



DUE

design:
Stefano Boeri Architetti

Ottone
Brass

made in italy

DU10



PVD-SG | forte®
Oro antico satinato
Antique satin gold



PVD-SB | forte® new
Bronzo satinato
Satin bronze



PGS | forte®
Grafite satinato
Satin graphite



OCS
Cromo satinato
Satin chrome



ONO
Nero
Black

coordinati per finestra
window complements

R DU25



DUE



DUE

design:
Stefano Boeri Architetti

Ottone
Brass

made in italy

DU11



PVD-SG | forte®
Oro antico satinato
Antique satin gold



PVD-SB | forte® new
Bronzo satinato
Satin bronze



PGS | forte®
Grafite satinato
Satin graphite



OCS
Cromo satinato
Satin chrome



ONO
Nero
Black

coordinati per finestra
window complements

R DU25



DUE

design:
Stefano Boeri Architetti

Ottone
Brass

made in italy

FINE DU40



PVD-SG | forte®
Oro antico satinato
Antique satin gold



PVD-SB | forte® new
Bronzo satinato
Satin bronze



PGS | forte®
Grafite satinato
Satin graphite



OCS
Cromo satinato
Satin chrome



U
ONO
Nero
Black

coordinati per finestra
window complements

VIS DU22V



U DU22U



DUE

design:
Stefano Boeri Architetti

Ottone
Brass

made in italy

FINE DU41



PVD-SG | forte®
Oro antico satinato
Antique satin gold



PVD-SB | forte® new
Bronzo satinato
Satin bronze



PGS | forte®
Grafite satinato
Satin graphite



OCS
Cromo satinato
Satin chrome



ONO
Nero
Black

coordinati per finestra
window complements

R DU25



Jaime Hayon



Artista-designer originario di Madrid, ha aperto il suo studio a Valencia nel 2010. Con uffici in Spagna, Italia e Giappone, progetta per Fritz Hansen, Bosa, Cassina, BD Barcelona, Wittmann, Magis, Ceccotti, &Tradition, Baccarat, Paola C, Bisazza, LLadro, Vicarbe, Arflex, Nani Marquina, Vista Alegre, Parachilna. Ha vinto numerosi premi internazionali ed è stato incluso da Wallpaper Magazine nella lista "Top 100", riconosciuto come uno dei creatori più influenti dell'ultimo decennio.

Artist-designer originally from Madrid, opened his studio in Valencia in 2010. With offices in Spain, Italy and Japan, he designs for Fritz Hansen, Bosa, Cassina, BD Barcelona, Wittmann, Magis, Ceccotti, &Tradition, Baccarat, Paola C, Bisazza, LLadro, Vicarbe, Arflex, Nani Marquina, Vista Alegre, Parachilna. He has won numerous awards and he has been included by Wallpaper Magazine in its "Top 100" list, recognised by the magazine as one of the most influential creators of the last decade.

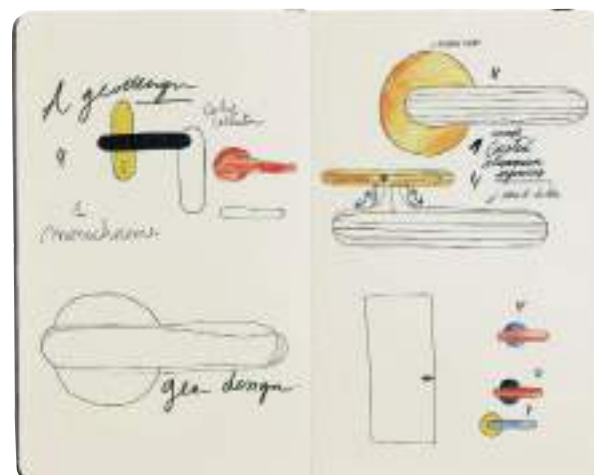

Zeppelin
Disegni della maniglia di /
Handle sketches by
Jaime Hayon

zeppelin



Volumi marcati e arrotondati come rimando formale - e decorativo - ai dirigibili Zeppelin dell'inizio del 1900, per una maniglia contemporanea, dalla sapiente realizzazione tecnica.

Pronounced rounded volumes as a formal - and decorative - reference to the Zeppelin airships of the early 1900s, for a contemporary handle made with great technical prowess.

zeppelin



zeppelin

design:
Jaime Hayon

Ottone
Brass

made in italy

vis ZP12



PVD-BG | forte®
Oro antico lucido
Antique bright gold



PVD-SG | forte®
Oro antico satinato
Antique satin gold



PVD-SCB | forte®
Rame satinato
Satin copper



PVN | forte® new
Nickel lucido
Bright nickel



PGS | forte®
Grafite satinato
Satin graphite



OC new
Cromo lucido
Polished chrome



OCS new
Cromo satinato
Satin chrome



OVE
Verde
Green

U



ONO
Nero
Black

coordinati per finestra *window complements*

vis ZP22V



U ZP22U



ZP27
maniglione
pull handle

967arch



Fondato a Milano nel 1999 da Cesare Chichi e Stefano Maestri, lo studio 967arch affianca all'attività di progettazione architettonica e di interior quella di design del prodotto in un continuo passaggio di influenze, sperimentazioni e contaminazioni. Il team ha affrontato progetti su scale differenti, con un focus particolare per le sedi e gli uffici di aziende tra cui Google, Petronas, WPP, Cisco e Ferrero. I progetti di design vedono collaborazioni con aziende come Poltrona Frau, Davide Groppi, Dieffebi, GE Giussani, MDF Italia, Zumtobel e Las Mobili.

Founded in Milan in 1999 by Cesare Chichi and Stefano Maestri, the firm 967arch combines activities of architectural and interior design with work on products, in a continuous exchange of influences, experimentation and contamination. The team has tackled projects on many different scales, with a particular focus on headquarters and offices for companies like Google, Petronas, WPP, Cisco and Ferrero. The projects of product design include collaborations with companies like Poltrona Frau, Davide Groppi, Dieffebi, GE Giussani, MDF Italia, Zumtobel and Las Mobili.

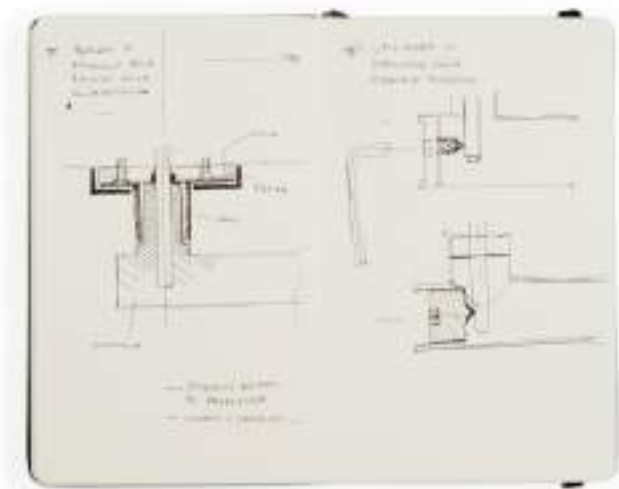

Blend
Disegni della maniglia di /
Handle sketches by
967arch

blend



Una maniglia nata dalla volontà di combinare forme elementari, cilindro e rettangolo, nella ricerca di un equilibrio complessivo ma soprattutto di una immediata e percettiva iconicità.

A handle based on the urge to combine basic forms, a cylinder and a rectangle, in pursuit of an overall balance and above all an immediate perceptive impact.

blend



blend

design:
967arch

Ottone
Brass

made in italy

BN10/R



PVD-SG | forte®
Oro antico satinato
Antique satin gold



PVD-SB | forte® new
Bronzo satinato
Satin bronze



PGS | forte®
Grafite satinato
Satin graphite



OCS
Cromo satinato
Satin chrome



BNL
Bianco lucido
Bright white



ONO
Nero
Black

coordinati per finestra
window complements

R BN25



BN10
maniglia su placca
handle on plate



blend



blend

design:
967arch

Ottone
Brass

made in italy

FINE BN40



PVD-SG | forte®
Oro antico satinato
Antique satin gold



PVD-SB | forte® new
Bronzo satinato
Satin bronze



PGS | forte®
Grafite satinato
Satin graphite



OCS
Cromo satinato
Satin chrome



BNL
Bianco lucido
Bright white



ONO
Nero
Black

coordinati per finestra
window complements

U BN22U



blend 02

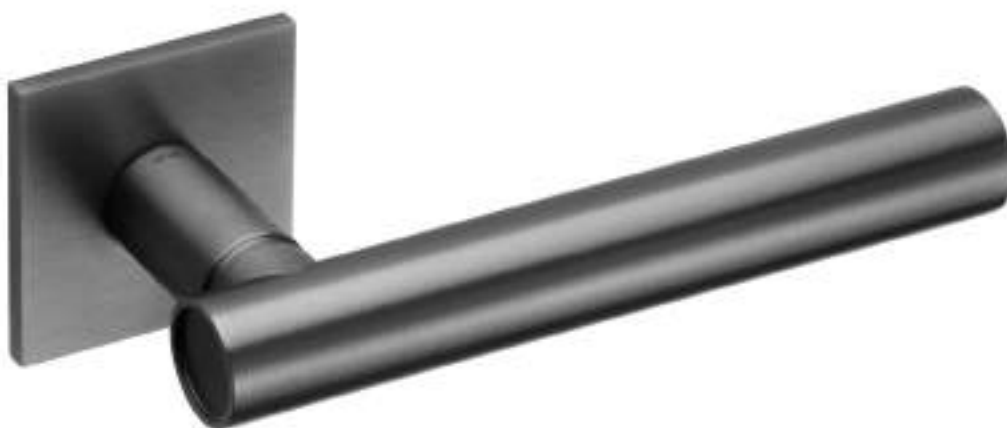

blend 02

design:
967arch

Ottone
Brass

made in italy

FINE BN41



PVD-SG | forte®
Oro antico satinato
Antique satin gold



PVD-SB | forte® new
Bronzo satinato
Satin bronze



PGS | forte®
Grafite satinato
Satin graphite



OCS
Cromo satinato
Satin chrome



BNL
Bianco lucido
Bright white



ONO
Nero
Black

coordinati per finestra
window complements

R BN25



BN10
maniglia su placca
handle on plate



Cino Zucchi



Nato a Milano, Cino Zucchi si è laureato in architettura al M.I.T. di Boston e al Politecnico di Milano. È autore di articoli e libri di teoria architettonica. Insieme allo studio OZA ha progettato e realizzato molti progetti: tra i più noti, quelli della ex Junghans a Venezia, dell'ex Alfa Romeo - Portello Nord e della Corte Verde a Milano; il master plan per Keski Pasila a Helsinki, la nuova sede Lavazza (TO), gli HQ Salewa (BZ).

Born in Milan, Cino Zucchi has earned degrees in Architectural Design at M.I.T. and at Politecnico di Milano. He is author of several articles and books on architectural and urban theory. With his studio OZA, he has designed and completed a number of projects, including the former Junghans factory site in Venice; the former Alfa Romeo-Portello Nord area and the Corte Verde in Milan; the Keski-Pasila master plan in Helsinki; the Lavazza HQ (TO); and the Salewa HQ (BZ).

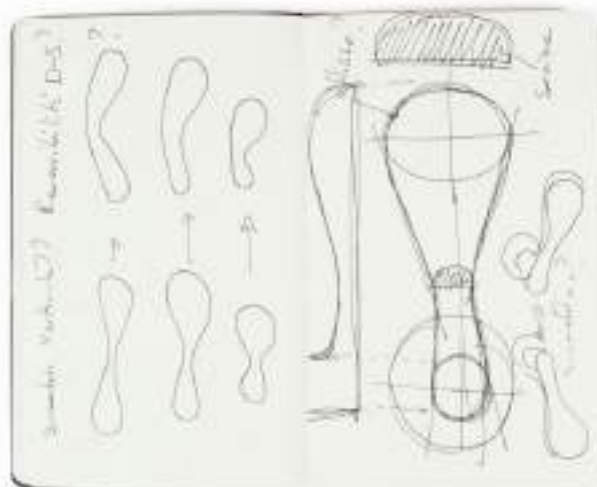

Drop
Disegni della maniglia di /
Handle sketches by
Cino Zucchi

drop



Una maniglia dalle
linee morbide e
affabili, in cui l'ottone
si lascia apprezzare
nella sua forma
migliore.

*A door handle
featuring a soft and
affable shape, in which
brass conveys its
allure thanks to the
best possible form.*

drop



drop

design:
Cino Zucchi

Ottone
Brass

made in italy

FINE DP40



PVD-SG | forte®
Oro antico satinato
Antique satin gold



PVD-SCB | forte®
Rame satinato
Satin copper



PVX | forte®
Inox satinato
Satin steel



PGS | forte®
Grafite satinato
Satin graphite

U



OCS
Cromo satinato
Satin chrome

coordinati per finestra
window complements

vis DP22V



U DP22U



luxury



Geometrie sfaccettate e tagli netti nella materia rimandano a celebri episodi dell'architettura contemporanea.

Faceted geometry and clean cuts in the material evoke famous episodes of contemporary architecture.

luxury

design:
Mauro Ronchi

Ottone
Brass

made in italy

FINE LU40



PVD-BG | forte®
Oro antico lucido
Antique bright gold



PVD-SG | forte®
Oro antico satinato
Antique satin gold



PVD-SCB | forte®
Rame satinato
Satin copper



PGS | forte®
Grafite satinato
Satin graphite



OGH
Bronzo satinato opaco
Matt satin bronze



OC
Cromo lucido
Polished chrome



OCS
Cromo satinato
Satin chrome



ONO
Nero
Black

coordinati per finestra
window complements

VIS LU22V



U LU22U



LU20C



LU27
maniglione
pull handle

luxury 02



Geometrie sfaccettate e tagli netti nella materia rimandano a celebri episodi dell'architettura contemporanea.

Faceted geometry and clean cuts in the material evoke famous episodes of contemporary architecture.

luxury 02

design:
Mauro Ronchi

Ottone
Brass

made in italy

FINE LU41



PVD-BG | forte®
Oro antico lucido
Antique bright gold



PVD-SG | forte®
Oro antico satinato
Antique satin gold



PVD-SCB | forte®
Rame satinato
Satin copper



PGS | forte®
Grafite satinato
Satin graphite



OGH
Bronzo satinato opaco
Matt satin bronze



OC
Cromo lucido
Polished chrome



OCS
Cromo satinato
Satin chrome



ONO
Nero
Black

coordinati per finestra
window complements

R LU25



LU23C



LU27
maniglione
pull handle



Inga Sempé



Nata a Parigi, nel 2000 è stata borsista a Villa Medici, presso l'Académie de France di Roma e, nello stesso anno, ha aperto il suo studio parigino. Le sue prime collaborazioni sono state con Edra e Cappellini. Oggi lavora con diverse aziende francesi, scandinave e italiane, tra le quali HAY, Ligne Roset, Wästberg, Magis, Alessi, Luceplan, Mutina, Crane, Rørros, Moustache, Svenskt Tenn, Gärsnäs.

Born in Paris, she was a fellow at Villa Medici in 2000, at the Académie de France in Rome and opened her Paris studio in the same year. Her first collaborations were with Edra and Cappellini. Today she works with several French, Scandinavian and Italian companies, including HAY, Ligne Roset, Wästberg, Magis, Alessi, Luceplan, Mutina, Crane, Rørros, Moustache, Svenskt Tenn, Gärsnäs.



Madeleine
Disegni della maniglia di /
Handle sketches by
Inga Sempé

madeleine



Un omaggio alla dolce
madeleine d'oltralpe
in una piccola maniglia
decorata che ne
riprende la forma
a conchiglia.

*A tribute to the
famous madeleine
cakes from beyond
the Alps, in a small
decorated handle
that replicates their
seashell form.*

madeleine

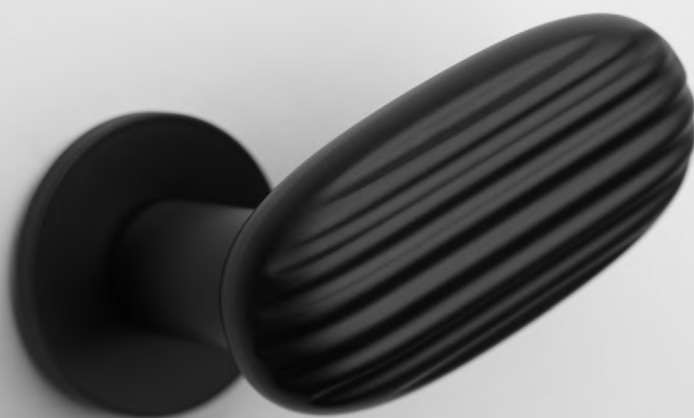

madeleine

design:
Inga Sempé

Ottone
Brass

made in italy

FINE MA40



PVD-BG | forte®
Oro antico lucido
Antique bright gold



PVD-SG | forte®
Oro antico satinato
Antique satin gold



PVD-SCB | forte®
Rame satinato
Satin copper



PVN | forte® new
Nickel lucido
Bright nickel



PGS | forte®
Grafite satinato
Satin graphite



ONO
Nero
Black



OC new
Cromo lucido
Polished chrome



OCS new
Cromo satinato
Satin chrome

coordinati per finestra
window complements

VS MA22V



U MA22U



intake



Disegnata per il Museo Casa Enzo Ferrari di Modena, solida nella materia e plastica nella forma, è un omaggio al car design più attento.

Designed for the Enzo Ferrari Museum in Modena, solid in terms of material, sculptural in terms of form, in a tribute to the finest automotive design.

intake

design:
Andrea Morgante

Ottone
Brass

made in italy

IN14



OC
Cromo lucido
Polished chrome



OBN
Bianco
White



ONO
Nero
Black

coordinati
complements



IN25
maniglione
pull handle

C-1918



Una maniglia - e una serie - d'autore caratterizzata dalla sapiente unione di acciaio e rame. Un progetto inedito, riscoperto e prodotto da Dnd con grande orgoglio.

A signature handle - and series - based on the felicitous combination of steel and copper. An original project, rediscovered and produced with great pride by Dnd.

C-1918

design:
Achille Castiglioni
Gianfranco Cavaglia

Acciaio inox AISI 316 + rame
AISI Stainless steel 316 + copper

made in italy

VIS CC12



L316 + R
AISI 316 lucido + inserto rame
PVD
*AISI 316 polished + PVD copper
insert*



S316 + R
AISI 316 satinato + inserto rame
PVD
*AISI 316 satin + PVD copper
insert*



L316 + N
AISI 316 lucido + inserto rame
nero
*AISI 316 polished + copper
black insert*



S316 + N
AISI 316 satinato + inserto rame
nero
*AISI 316 satin + copper black
insert*

coordinati per finestra
window complements

CC22



CC25
maniglione
pull handle

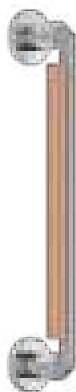

short



Linee morbide dall'appeal immediato. Una maniglia dal design compatto ed equilibrato, molto apprezzata per la sua versatilità di applicazione in termini di stile e finiture.

The immediate appeal of soft lines. A compact and balanced design defines this handle, very appreciated thanks to its versatility, both style and finishes.

short

design:
Karim Rashid

Ottone
Brass

made in italy

FINE SH40



PVD-BG | forte® new
Oro antico lucido
Antique bright gold



PVD-SG | forte®
Oro antico satinato
Antique satin gold



PVD-SCB | forte®
Rame satinato
Satin copper



PVD-BB | forte® new
Bronzo lucido
Bright bronze



PVD-SB | forte® new
Bronzo satinato
Satin bronze



PGS | forte®
Grafite satinato
Satin graphite



OC
Cromo lucido
Polished chrome



OCS
Cromo satinato
Satin chrome



AB
Bronzato
Antique bronze



OBN new
Bianco
White



ONO
Nero
Black

coordinati per finestra
window complements

VIS SH22V



U SH22U



SH22OC



edra 02

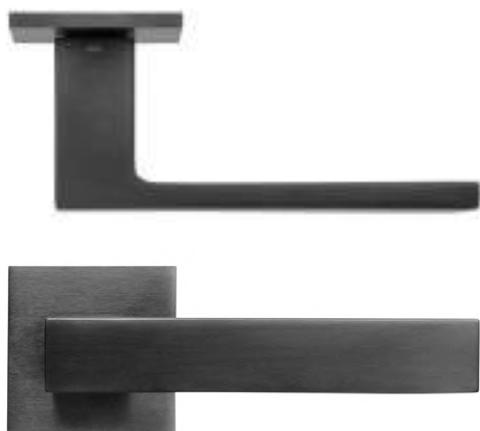

La forza di una forma
archetipica: l'idea
stessa di maniglia
si concretizza in
geometrie e volumi di
essenziale purezza.

*The force of
archetypal form: the
idea of the handle
itself embodied by
geometric lines and
volumes of essential
purity.*

edra 02

design:
Mauro Ronchi

Ottone
Brass

made in italy

FINE ED41



PVD-SG | forte®
Oro antico satinato
Antique satin gold



PVD-SCB | forte®
Rame satinato
Satin copper



PVX | forte®
Inox satinato
Satin steel



PGS | forte®
Grafite satinato
Satin graphite



OGH
Bronzo satinato opaco
Matt satin bronze



OC
Cromo lucido
Polished chrome



OCS
Cromo satinato
Satin chrome



ONS
Nickel satinato
Satin nickel



ONO
Nero
Black

coordinati per finestra *window complements*

R ED25



ED26C



ED60
maniglione per alzante
scorrevole
*pull handle for lift sliding
system*



LO25
maniglione
pull handle

ginevra



ginevra

design:
Dnd technical division

Ottone
Brass

made in italy

R G119



PVD-BG | forte®
Oro antico lucido
Antique bright gold



PVD-SG | forte®
Oro antico satinato
Antique satin gold



PVN | forte® new
Nickel lucido
Bright nickel



PGS | forte®
Grafite satinato
Satin graphite



OGH
Bronzo satinato opaco
Matt satin bronze



OC new
Cromo lucido
Polished chrome



OCS new
Cromo satinato
Satin chrome

coordinati per finestra
window complements

R G125



fluke



Una forma
dinamica che nasce
dall'incontro di due
volumi troncoconici
contrapposti: il segno
forte di un design
riconoscibile e
riconosciuto.

*A dynamic form
that arises from
the meeting of two
opposing cones:
the vivid impact of a
recognizable design.*

fluke

design:
Karim Rashid

Ottone
Brass

made in italy

® FK14



PVD-BG | forte® new
Oro antico lucido
Antique bright gold



PVD-SG | forte® new
Oro antico satinato
Antique satin gold



PVD-SB | forte® new
Bronzo satinato
Satin bronze



PGS | forte® new
Grafite satinato
Satin graphite



OC
Cromo lucido
Polished chrome



OCS
Cromo satinato
Satin chrome

coordinati per finestra
window complements

® FK22V



FK27
maniglione
pull handle



aretè 02



Geometrie sfaccettate e tagli netti nella materia rimandano a celebri episodi dell'architettura contemporanea.

A game of openness and fullness in a precise squared surface, lightened by small triangular cutouts for a decorative touch.

aretè 02

design:
Mauro Ronchi

Ottone
Brass

made in italy

FINE AT41



PVD-SG | forte®
Oro antico satinato
Antique satin gold



PVX | forte®
Inox satinato
Satin steel



PGS | forte®
Grafite satinato
Satin graphite



OGH
Bronzo satinato opaco
Matt satin bronze

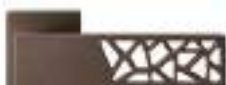

AB
Bronzato
Antique bronze



OC
Cromo lucido
Polished chrome



OCS
Cromo satinato
Satin chrome

coordinati per finestra
window complements

R AT25



AT27
maniglione
pull handle



aretè



aretè

design:
Mauro Ronchi

Ottone
Brass

made in italy

FINE AT40



PVD-SG | forte®
Oro antico satinato
Antique satin gold



PVX | forte®
Inox satinato
Satin steel



PGS | forte®
Grafite satinato
Satin graphite



OGH
Bronzo satinato opaco
Matt satin bronze



AB
Bronzato
Antique bronze



OC
Cromo lucido
Polished chrome



OCS
Cromo satinato
Satin chrome

coordinati per finestra
window complements

VIS AT22V



U AT22U



AT27
maniglione
pull handle



aretè L



Il nitore di una
geometria classica
dal sapore
contemporaneo: una
maniglia che parla di
sostanziosa semplicità.

*The clarity of classical
geometry with a
contemporary mood:
a handle that speaks
of sophisticated
simplicity.*

aretè L

design:
Mauro Ronchi

Ottone
Brass

made in italy

AL40



PVD-SG | forte®
Oro antico satinato
Antique satin gold



PVX | forte®
Inox satinato
Satin steel



PGS | forte®
Grafite satinato
Satin graphite



OGH
Bronzo satinato opaco
Matt satin bronze



AB
Bronzato
Antique bronze



OC
Cromo lucido
Polished chrome



OCS
Cromo satinato
Satin chrome

coordinati per finestra
window complements

AL22V



AL22U



AL27
maniglione
pull handle



aretè L 02



aretè L 02

design:
Mauro Ronchi

Ottone
Brass

made in italy

FINE AL41



PVD-SG | forte®
Oro antico satinato
Antique satin gold



PVX | forte®
Inox satinato
Satin steel



PGS | forte®
Grafite satinato
Satin graphite



OGH
Bronzo satinato opaco
Matt satin bronze



AB
Bronzato
Antique bronze



OC
Cromo lucido
Polished chrome



OCS
Cromo satinato
Satin chrome

coordinati per finestra
window complements

R AL25



AL27
maniglione
pull handle



change B 02



change B 02

design:
Sandro Santantonio

Ottone
Brass

made in italy

VIS CB14



OCS
Cromo satinato
Satin chrome



CCS
Cromo - Cromo satinato
Chrome - Satin chrome



OBN
Bianco
White



ONO
Nero
Black

coordinati per finestra
window complements

R CB25



cloe



cloe

design:
Dnd technical division

Ottone
Brass

made in italy

CL40



PVD-BG | forte®
Oro antico lucido
Antique bright gold



PVD-SG | forte®
Oro antico satinato
Antique satin gold



PGS | forte®
Grafite satinato
Satin graphite



OC
Cromo lucido
Polished chrome



OCS
Cromo satinato
Satin chrome



ONO new
Nero
Black

coordinati per finestra
window complements

CL22V



CL27
maniglione
pull handle



cloe 02



cloe 02

design:
Dnd technical division

Ottone
Brass

made in italy

FINE CL41



PVD-BG | forte®
Oro antico lucido
Antique bright gold



PVD-SG | forte®
Oro antico satinato
Antique satin gold



PGS | forte®
Grafite satinato
Satin graphite



OC
Cromo lucido
Polished chrome



OCS
Cromo satinato
Satin chrome



ONO new
Nero
Black

coordinati per finestra
window complements

R CL25



project



project

design:
Dnd technical division

Ottone
Brass

made in italy

vis PR12



OLV
Lucido
Polished



OS
Satinato
Satin



AB
Bronzato
Antique bronze



OC
Cromo lucido
Polished chrome



OCS
Cromo satinato
Satin chrome



ONS
Nickel satinato
Satin nickel



ONO
Nero
Black

coordinati per finestra *window complements*

vis PR22V



u PR22U



PR27
maniglione
pull handle



PR29
maniglione
pull handle

project 02



project 02

design:
Dnd technical division

Ottone
Brass

made in italy

VIS PR14



AB
Bronzato
Antique bronze



OC
Cromo lucido
Polished chrome



OCS
Cromo satinato
Satin chrome



ONS
Nickel satinato
Satin nickel



ONO
Nero
Black

coordinati per finestra
window complements

VIS PR25V



PR36
pomolo
knob



PR27
maniglione
pull handle



PR29
maniglione
pull handle



havana



havana

design:
Studio Hot Lab

made in italy

Ottone e pelle di prima
qualità "pieno fiore"
*Brass and high quality
leather*

VIS HV12



PVD-BG | forte® + VE
Oro antico lucido + Verde
Antique bright gold + Green



PVD-SG | forte® + VE
Oro antico satinato + Verde
Antique satin gold + Green



PVD-BG | forte® + PA new
Oro antico lucido + Papaya
Antique bright gold + Papaya



PVD-SG | forte® + PA new
Oro antico satinato + Papaya
Antique satin gold + Papaya



OC + NA
Cromo lucido + Navy
Polished chrome + Navy



OCS + NA
Cromo satinato + Navy
Satin chrome + Navy



OCS + PA
Cromo satinato + Papaya
Satin chrome + Papaya

coordinati per finestra
window complements

VIS HV22V



dolce



dolce

design:
Mauro Ronchi

Ottone
Brass

made in italy

vis DO12



PVD-BG | forte® new
Oro antico lucido
Antique bright gold



PVD-SG | forte® new
Oro antico satinato
Antique satin gold



OGH
Bronzo satinato opaco
Matt satin bronze



OC
Cromo lucido
Polished chrome



OCS
Cromo satinato
Satin chrome



ONS
Nickel satinato
Satin nickel

coordinati per finestra
window complements

vis DO22V



DO10
maniglia su placca
handle on plate



linear



linear

design:
Mauro Ronchi

Ottone
Brass

made in italy

LI40



PVD-BG | forte®
Oro antico lucido
Antique bright gold



PVD-SG | forte®
Oro antico satinato
Antique satin gold



OGH
Bronzo satinato opaco
Matt satin bronze



OC
Cromo lucido
Polished chrome

U



OCS
Cromo satinato
Satin chrome

coordinati per finestra
window complements

LI22V



LI22U



LI10
maniglia su placca
handle on plate



LI25
maniglione
pull handle



art



art

design:
Mauro Ronchi

Ottone
Brass

made in italy

AR40



PVD | forte®
Oro lucido
Bright gold



PVD-BB | forte® new
Bronzo lucido
Bright bronze



PVD-SB | forte® new
Bronzo satinato
Satin bronze



OGH
Bronzo satinato opaco
Matt satin bronze



OC
Cromo lucido
Polished chrome



OCS
Cromo satinato
Satin chrome



ONS
Nickel satinato
Satin nickel

coordinati per finestra
window complements

AR22V



AR22U



AR10
maniglia su placca
handle on plate



AR25
maniglione
pull handle

blip



blip

design:
Karim Rashid

Ottone
Brass

made in italy

vis **BL12**



OC
Cromo lucido
Polished chrome



OCS
Cromo satinato
Satin chrome



ONO
Nero
Black

vita



vita

design:
Mauro Ronchi

Ottone
Brass

made in italy

vis V112



PVD | forte®
Oro lucido
Bright gold



PVX | forte®
Inox satinato
Satin steel



PGS | forte®
Grafite satinato
Satin graphite



OC
Cromo lucido
Polished chrome



OCS
Cromo satinato
Satin chrome



ONS
Nickel satinato
Satin nickel

coordinati per finestra
window complements

vis V122V



V110
maniglia su placca
handle on plate



ovum



ovum

design:
Poggi Mariani

Ottone
Brass

made in italy

FINE 62/40



OLV
Lucido
Polished



BSO
Bronzo sabbiato opaco
Matt sandblasted bronze



OCS new
Cromo satinato
Satin chrome



NSV
Nickel sabbiato opaco
Matt sandblasted nickel



OBN new
Bianco
White



ONO
Nero
Black

coordinati per finestra
window complements

VIS 62V



twist

design:
Karim Rashid

Ottone
Brass

made in italy



R TW14



OC
Cromo lucido
Polished chrome



OCS
Cromo satinato
Satin chrome



ONS
Nickel satinato
Satin nickel

coordinati per finestra
window complements

VIS TW22V



twist 02

design:
Karim Rashid

made in italy

Ottone
Brass

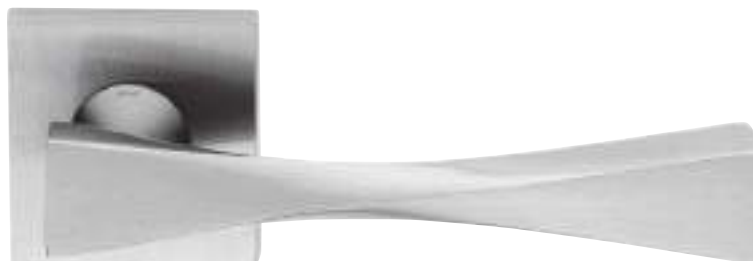

vis TW13



OC
Cromo lucido
Polished chrome



OCS
Cromo satinato
Satin chrome



ONS
Nickel satinato
Satin nickel

coordinati per finestra
window complements

R TW25



sike

design:
Karim Rashid

made in italy

Ottone
Brass



Good Design Awards
2006

R SK14



PVD-SG | forte® new
Oro antico satinato
Antique satin gold



PGS | forte® new
Grafite satinato
Satin graphite



OC
Cromo lucido
Polished chrome



OCS
Cromo satinato
Satin chrome

coordinati per finestra
window complements

vis SK22V



sike 02

design:
Karim Rashid

made in italy

Ottone
Brass



VIS SK13



PVD-SG | forte® new
Oro antico satinato
Antique satin gold

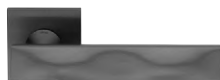

PGS | forte® new
Grafite satinato
Satin graphite



OC
Cromo lucido
Polished chrome



OCS
Cromo satinato
Satin chrome

coordinati per finestra
window complements

R SK25



project zancata

design:
Dnd technical division

made in italy

Ottone
Brass



vis PO12



PVD | forte®
Oro lucido
Bright gold



OC
Cromo lucido
Polished chrome



OCS
Cromo satinato
Satin chrome



ONS
Nickel satinato
Satin nickel

project zancata 02

design:
Dnd technical division

made in italy

Ottone
Brass



vis PO14



PVD | forte®
Oro lucido
Bright gold



OC
Cromo lucido
Polished chrome



OCS
Cromo satinato
Satin chrome



ONS
Nickel satinato
Satin nickel

fluò

design:
Mauro Ronchi

Ottone
Brass

made in italy



vis FL12



OLV
Lucido
Polished



OC
Cromo lucido
Polished chrome



OCS
Cromo satinato
Satin chrome

coordinati per finestra
window complements

vis FL22V



FL10
maniglia su placca
handle on plate



go

design:
Mauro Ronchi
made in italy

Ottone
Brass



vis GO12



OC
Cromo lucido
Polished chrome



OCS
Cromo satinato
Satin chrome

coordinati per finestra
window complements

vis GO22V

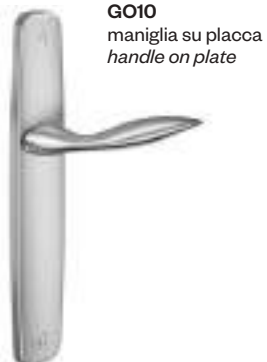

GO10
maniglia su placca
handle on plate

mix

design:
Dnd technical division

made in italy

Ottone, zama e acciaio
Brass, zamak and stainless steel



VIS MI12



OC + R
Cromo lucido + Rete
Polished chrome + Screen



OCS + R
Cromo satinato + Rete
Satin chrome + Screen



CNE
Cromo lucido - Nero
Polished chrome - Black



CSNE
Cromo satinato - Nero
Satin chrome - Black

coordinati per finestra
window complements

VIS MI22V



silvyana

design:
Poggi Mariani

made in italy

Ottone
Brass



FINE 52/41



OCS new
Cromo satinato
Satin chrome



CCS
Cromo - Cromo satinato
Chrome - Satin chrome



NSV
Nickel sabbato opaco
Matt sandblasted nickel



ONO
Nero
Black

coordinati per finestra
window complements

VIS 52QV



thelma

design:
Poggi Mariani

made in italy

Ottone
Brass



VIS 82/12



OLV
Lucido
Polished



OCS new
Cromo satinato
Satin chrome



NSV
Nickel sabbiato opaco
Matt sandblasted nickel



ONO
Nero
Black

coordinati per finestra
window complements

VIS 82V



elena

design:
Poggi Mariani

made in italy

Ottone
Brass



119/40



OLV
Lucido
Polished



OC
Cromo lucido
Polished chrome



OCS
Cromo satinato
Satin chrome



ONO
Nero
Black

coordinati per finestra
window complements

119V



denise

design:
Poggi Mariani

made in italy

Ottone
Brass



FINE 11/41



OC
Cromo lucido
Polished chrome



OCS new
Cromo satinato
Satin chrome



ONO
Nero
Black

coordinati per finestra
window complements

VIS 11V



mj

design:
Poggi Mariani

Ottone
Brass

made in italy



85/40



OC
Cromo lucido
Polished chrome



NSV
Nickel sabbato opaco
Matt sandblasted nickel



ONO
Nero
Black

coordinati per finestra
window complements

85V



– premium

maniglie
premium

door handles

pluris NEW



Una maniglia dal design nitido, pulito ed essenziale trova la forma di un volume rettangolare stonato. La rosetta è contenuta nella proiezione della leva.

A handle with a sharp, clean and essential design finds its shape in a rounded rectangular volume. The escutcheon is contained within the projection of the lever.

pluris

design:
Giulio lacchetti

Zama
Zamak

made in italy

PS48



ZRO
Oro satinato
Satin gold



ZBR
Bronzo
Bronze



ZCS
Cromo satinato
Satin chrome



ZBN
Bianco
White



ZAN
Antracite
Anthracite



ZNE
Nero
Black

Philippe Tabet



Nato e cresciuto in Francia, a Versailles, ha studiato design industriale a Lione e Parigi. Vive a Milano, dove dal 2014 ha sede il suo studio di progettazione e dove insegna presso Domus Academy e Naba.

Collabora con aziende rinomate quali Pianca, Lexon, Infiniti Design e Plust e al contempo sviluppa un suo percorso artigianale, con processi e risultati che esplorano materiali e tecniche di lavorazione – come per la serie di maschere Order.

Ha vinto il premio Infiniti Design nel 2014 e Young&Design nel 2017; ha ottenuto il Good Design Award nel 2018.

Born and raised in Versailles, France, he studied industrial design in Lyon and Paris. He now lives in Milan, where he established his design firm in 2014 and where he teaches at Domus Academy and Naba.

He collaborates with renowned companies such as Pianca, Lexon, Infiniti Design and Plust, whilst at the same time following his own path as a craftsman, with processes and results that are explorations of materials and techniques, as can be seen from Order, his series of masks.

He won the Infiniti Design award in 2014 and the Young&Design award in 2017, before garnering the Good Design Award in 2018.

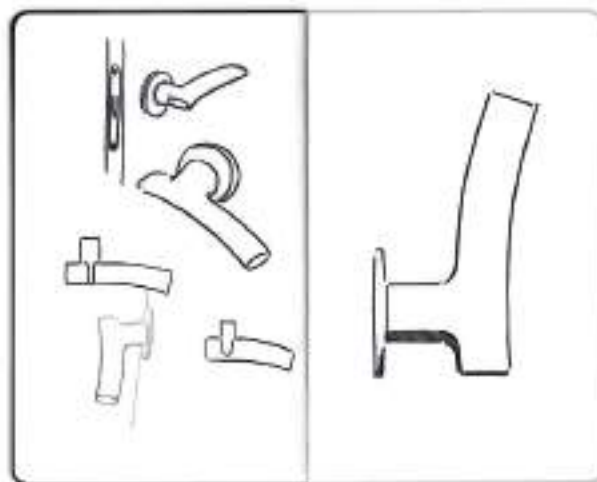

San
Disegni della maniglia di /
Handle sketches by
Philippe Tabet

san



Come a ricordare l'elegante e slanciato profilo di una katana. Curve morbide e in tangenza caratterizzano questa originale maniglia dall'estetica e dal nome, di ispirazione giapponese.

Delicately reminiscent of the elegant, slender profile of a katana. Soft, tangential curves characterise this original handle with a Japanese-inspired name and aesthetic.

san

design:
Philippe Tabet

Zama
Zamak

made in italy

VIS SN12



ZC
Cromo lucido
Polished chrome



ZCS
Cromo satinato
Satin chrome



ZAN
Antracite
Anthracite



ZNE
Nero
Black

coordinati per finestra
window complements

VIS SN22V



U SN22U



san 02

design:
Philippe Tabet

Zama
Zamak

made in italy

VIS SN14



ZC
Cromo lucido
Polished chrome



ZCS
Cromo satinato
Satin chrome



ZAN
Antracite
Anthracite



ZNE
Nero
Black

coordinati per finestra
window complements

VIS SN25V



Mario Scairato



Vive e lavora tra Milano e Paestum, la città da cui proviene. Si è laureato in Industrial Design allo IUAV / Università della Repubblica di San Marino nel 2011 e dal 2015 ha disegnato per diversi marchi, tra cui Alessi, Internoitaliano e Moleskine. Dal 2015 è art director di Paestum Experience, un progetto di branding da lui fondato che mira alla promozione e alla comunicazione della città di Capaccio Paestum.

He lives and works between Milan and Paestum, his hometown. He graduated in Industrial Design at the IUAV / Università della Repubblica di San Marino in 2011. Since 2015 he has designed for some brands including Alessi, Internoitaliano and Moleskine. He has been art director of Paestum Experience since 2015, a branding project he founded that aims to promote and communicate the city of Capaccio Paestum.

Alessandro Stabile



Originario di Milano, è uno dei dieci "Top Young Italian Industrial Designers" selezionati dall'Istituto Italiano di Cultura di New York nel 2013. Nel 2011 ha fondato il suo studio ed è specializzato in product design e direzione artistica. Nel 2016 due suoi progetti hanno vinto il primo e il secondo premio Young&Design come i due migliori prodotti presentati alla Milano Design Week da un under 35. Disegna per diversi brand tra cui Moleskine, Alessi, Ferrero Nutella.

Originally from Milan, he is one of the ten "Top Young Italian Industrial Designers" selected by the Italian Cultural Institute in New York in 2013. In 2011 he founded his design studio specialising in product design and artistic direction. In 2016 two of his ideas won the first and the second prizes of the Young&Design Award, as the best projects of Milan Design Week from an under 35. He designs for different brands such as Moleskine, Alessi, Ferrero Nutella.

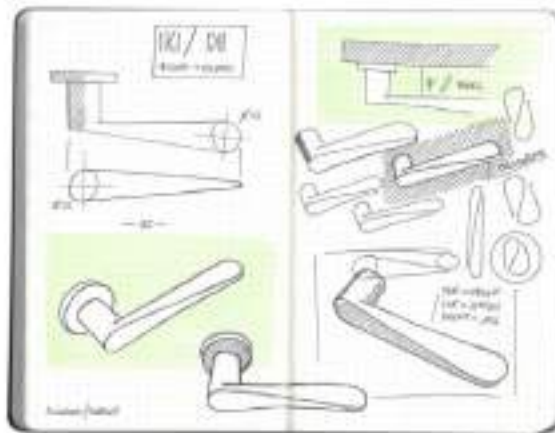

Iki
Disegni della maniglia di /
Handle sketches by
Mario Scairato +
Alessandro Stabile

iki



Una costruzione formale palindroma: il profilo della vista superiore è identico a quello della vista frontale, ribaltato di 180 gradi. Una forma elegante ed essenziale, un volume mutevole che suggerisce all'utente la presa con il suo profilo frontale.

A palindromic structural form: the profile in the view from above is identical to that of the frontal view, but reversed by 180 degrees. An elegant and essential form, a mutable volume that suggests the proper grip with its frontal profile.

iki



iki

design:
Mario Sciarato
Alessandro Stabile

Zama
Zamak

made in italy

vis IK12



ZCS
Cromo satinato
Satin chrome



ZAN
Antracite
Anthracite



ZNE
Nero
Black

coordinati per finestra
window complements

vis IK22V



u IK22U



luce



La maniglia come fatto scultoreo, dove la luce evidenzia morbidezze e taglia i volumi in modo netto per restituirci l'idea stessa di un concetto plastico fuori dal tempo.

The handle as sculpture, where light brings out softness and volumes with clarity, conveying the idea of a timelessly shaped object.

luce

design:
Dnd technical division

Zama
Zamak

made in italy

VIS LC12



ZC
Cromo lucido
Polished chrome



ZCS
Cromo satinato
Satin chrome



ZNS
Nickel satinato
Satin nickel



ZOS
Ottonato satinato
Satin brass colour



ZGH
Bronzo satinato opaco
Matt satin bronze



ZAN
Antracite
Anthracite



ZBN
Bianco
White



ZNE
Nero
Black

coordinati per finestra
window complements

VIS LC30V



U LC30U



LC50
maniglione per alzante
scorrevole
*pull handle for lift sliding
system*



LC26
maniglione
pull handle

luce 02



luce 02

design:
Dnd technical division

Zama
Zamak

made in italy

VIS LC14



ZC
Cromo lucido
Polished chrome



ZCS
Cromo satinato
Satin chrome



ZNS
Nickel satinato
Satin nickel



ZOS
Ottonato satinato
Satin brass colour



ZGH
Bronzo satinato opaco
Matt satin bronze



ZAN
Antracite
Anthracite



ZBN
Bianco
White



ZNE
Nero
Black

coordinati per finestra
window complements

VIS LC31V



LC60
maniglione per alzante scorrevole
pull handle for lift sliding system



luce p

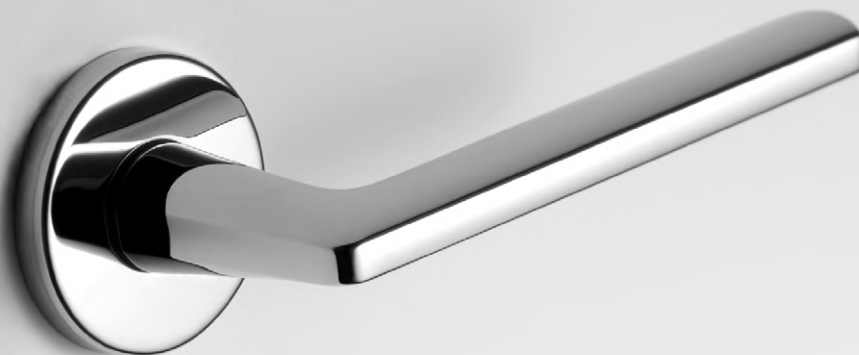

Una leva dalle geometrie solide e pulite, disegnate e costruite con attenzione intorno a un angolo di 90 gradi. Presa ergonomica e appeal contemporaneo, con la luce che enfatizza i profili.

A lever with solid, clean geometries, carefully designed and constructed around a 90-degree angle. Ergonomic grip and contemporary appeal, with light emphasising the profiles.

luce p

design:
Dnd technical division

Zama
Zamak

made in italy

VIS LP12



ZC
Cromo lucido
Polished chrome



ZCS
Cromo satinato
Satin chrome



ZNS
Nickel satinato
Satin nickel



ZOS
Ottonato satinato
Satin brass colour



ZGH
Bronzo satinato opaco
Matt satin bronze



ZAN
Antracite
Anthracite



ZBN
Bianco
White



ZNE
Nero
Black

coordinati per finestra
window complements

VIS LP22V



U LP22U



LP50
maniglione per alzante scorrevole
pull handle for lift sliding system

luce p 02



luce p 02

design:
Dnd technical division

Zama
Zamak

made in italy

VIS LP14



ZC
Cromo lucido
Polished chrome



ZCS
Cromo satinato
Satin chrome



ZNS
Nickel satinato
Satin nickel



ZOS
Ottonato satinato
Satin brass colour



ZGH
Bronzo satinato opaco
Matt satin bronze



ZAN
Antracite
Anthracite



ZBN
Bianco
White



ZNE
Nero
Black

coordinati per finestra
window complements

VIS LP25V



LP60
maniglione per alzante scorrevole
pull handle for lift sliding system



chop



chop

design:
Didier Schweizer

Zama
Zamak

made in italy

vis CP12



ZC
Cromo lucido
Polished chrome



ZCS
Cromo satinato
Satin chrome



ZOS
Ottonato satinato
Satin brass colour



ZGH
Bronzo satinato opaco
Matt satin bronze



ZAN
Antracite
Anthracite



ZNE
Nero
Black

coordinati per finestra
window complements

vis CP22V



u CP22U



esa



esa

design:
Mauro Ronchi

Alluminio e zama
Aluminium and zamak

made in italy

VIS ES14



CCS
Cromo - Cromo satinato
Chrome - Satin chrome



CBI
Cromo - Bianco
Chrome - White



SBI
Cromo satinato - Bianco
Satin chrome - White



CNE
Cromo - Nero
Chrome - Black



SNE
Cromo satinato - Nero
Satin chrome - Black



ZNE
Nero
Black

coordinati per finestra
window complements

VIS ES25V



sochic



sohic

design:
Dnd technical division

Zama
Zamak

made in italy

vis SC12



ZOR
Placcato oro 24K
Gold plated 24K



ZC
Cromo lucido
Polished chrome



ZNE
Nero
Black

sohic 02

vis SC14



ZOR
Placcato oro 24K
Gold plated 24K



ZC
Cromo lucido
Polished chrome



ZNE
Nero
Black

coordinati per finestra
window complements

vis SC22V



U SC22U



vis SC25V



sochic L



sochic L

design:
Dnd technical division

Zama + legno
Zamak + wood

made in italy

VIS SL12



SPB
Cromo satinato + inserto
palissandro bianco
*Satin chrome + white Rosewood
insert*



SLS
Cromo satinato + inserto larice
sabbia
*Satin chrome + sand Larchwood
insert*



SRT
Cromo satinato + inserto rovere
tanchè
*Satin chrome + tanchè Oakwood
insert*



SPL
Cromo satinato + inserto
palissandro scuro
*Satin chrome + dark Rosewood
insert*

sochic L 02

FINE SL41



NPB
Nero + inserto palissandro bianco
Black + white Rosewood insert



NLS
Nero + inserto larice sabbia
Black + sand Larchwood insert



NRT
Nero + inserto rovere tanchè
Black + tanchè Oakwood insert



NPL
Nero + inserto palissandro
scuro
Black + dark Rosewood insert

coordinati per finestra
window complements

VIS SL22V



VIS SL25V



fold

design:
Mario Padiglione

made in italy

Zama
Zamak



VIS FO12



ZC
Cromo lucido
Polished chrome



ZCS
Cromo satinato
Satin chrome



ZAN
Antracite
Anthracite



ZNE
Nero
Black

coordinati per finestra
window complements

VIS FO22V



fold 02

design:
Mario Padiglione

made in italy

Zama
Zamak



vis FO14



ZC
Cromo lucido
Polished chrome



ZCS
Cromo satinato
Satin chrome



ZAN
Antracite
Anthracite



ZNE
Nero
Black

coordinati per finestra
window complements

vis FO25V



joy

design:
Nicola Novelletto

Zama
Zamak

made in italy



vis JO12



ZCS
Cromo satinato
Satin chrome



ZNS
Nickel satinato
Satin nickel



ZAN
Antracite
Anthracite



ZNE
Nero
Black

coordinati per finestra
window complements

vis JO22V



joy 02

design:
Nicola Novelletto

made in italy

Zama
Zamak



vis JO14



ZCS
Cromo satinato
Satin chrome



ZNS
Nickel satinato
Satin nickel



ZAN
Antracite
Anthracite



ZNE
Nero
Black

coordinati per finestra
window complements

vis JO25V



holly

design:
Dnd technical division

Zama
Zamak

made in italy



vis HO14



ZCS
Cromo satinato
Satin chrome



ZBN
Bianco
White



ZNE
Nero
Black

coordinati per finestra
window complements

vis HO25V



minima

design:
Dnd technical division

Zama
Zamak

made in italy



vis MN12



ZCCS
Cromo lucido + Cromo satinato
Polished chrome + Satin chrome



ZCBI
Cromo lucido + Bianco
Polished chrome + White



ZCNE
Cromo lucido + Nero
Polished chrome + Black

coordinati per finestra
window complements

vis MN22V



stick 02

design:
Novelletto - Greco

made in italy

Zama
Zamak



vis 861/14



ZCS
Cromo satinato
Satin chrome



ZNE new
Nero
Black

coordinati per finestra
window complements

vis 866V



nova

design:
Mauro Ronchi

Ottone
Brass

made in italy



vis 663/12



OC
Cromo lucido
Polished chrome



OCS
Cromo satinato
Satin chrome



ONS
Nickel satinato
Satin nickel

coordinati per finestra
window complements

vis 666V



660
maniglia su placca
handle on plate



link

design:
Mauro Ronchi

made in italy

Ottone
Brass



vis 653/12



OC
Cromo lucido
Polished chrome



OCS
Cromo satinato
Satin chrome



ONS
Nickel satinato
Satin nickel

coordinati per finestra
window complements

vis 656V



650
maniglia su placca
handle on plate

quattro 02

design:
Dnd technical division
made in italy

Zama
Zamak



vis 264/14-Z



ZOS
Ottonato satinato
Satin brass colour



ZGH
Bronzo satinato opaco
Matt satin bronze



ZCS
Cromo satinato
Satin chrome



ZNS
Nickel satinato
Satin nickel

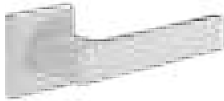

ZBN
Bianco
White



ZAN
Antracite
Anthracite



ZNE
Nero
Black

coordinati per finestra
window complements

vis 266-ZV





VIS 411/12-Z



ZCS
Cromo satinato
Satin chrome



ZAN
Antracite
Anthracite



ZNE
Nero
Black

coordinati per finestra
window complements

VIS 414-ZV



artik

Zama / Zamak

design: Dnd
technical division
made in italy



vis 893/14



ZCS
Cromo satinato
Satin chrome



ZAN
Antracite
Anthracite



ZNE
Nero
Black

tipo-z

Zama / Zamak

design: Pietro Silva
made in italy

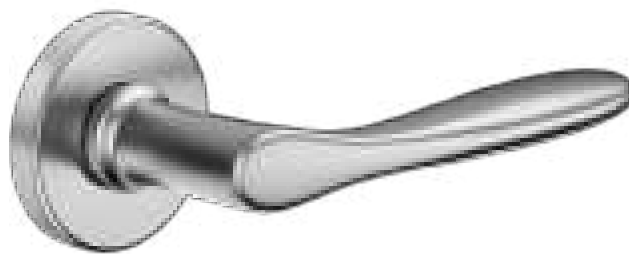

vis 172/12-Z



ZC
Cromo lucido
Polished chrome



ZCS
Cromo satinato
Satin chrome



ZNS
Nickel satinato
Satin nickel

S40

made in italy

Acciaio inox AISI 316
Stainless steel AISI 316



vis S40/12



S316
Acciaio AISI 316 satinato
AISI 316 satin steel

S50

made in italy

Acciaio inox AISI 316
Stainless steel AISI 316



vis S50/12



S316
Acciaio AISI 316 satinato
AISI 316 satin steel

S60

made in italy

Acciaio inox AISI 316
Stainless steel AISI 316



MS S60/12



PVD-SG | forte® new
Oro antico satinato
Antique satin gold



PVD-SB | forte® new
Bronzo satinato
Satin bronze



PGS | forte® new
Grafite satinato
Satin graphite



S316
Acciaio AISI 316 satinato
AISI 316 satin steel



S316/N
Nero
Black

– classic

maniglie
classic

door handles

latina

design:
Mauro Ronchi

Ottone
Brass

made in italy



VIS 823/12



OLV
Lucido
Polished

R 824



OGH
Bronzo satinato opaco
Matt satin bronze



BSS
Bronzo scuro sfumato
Shaded dark bronze

coordinati per finestra
window complements

VIS 829V



820
maniglia su placca
handle on plate



110
maniglione
pull handle



appia

design:
Mauro Ronchi
made in italy

Ottone
Brass



R 834



OLV
Lucido
Polished

vis 833/12



BSS
Bronzo scuro sfumato
Shaded dark bronze



OGH
Bronzo satinato opaco
Matt satin bronze

coordinati per finestra
window complements

vis 839V



830
maniglia su placca
handle on plate



lady

design:
Dnd technical division

Ottone
Brass

made in italy



B 568/B



OLV
Lucido
Polished



OGH
Bronzo satinato opaco
Matt satin bronze



BSS
Bronzo scuro sfumato
Shaded dark bronze

coordinati per finestra
window complements

VIS 565V



567
maniglia su placca
handle on plate

lirica

design:
Dnd technical division

Ottone
Brass

made in italy



vis 806/12



OLV
Lucido
Polished



OCS
Cromo satinato
Satin chrome



ONV
Nickel lucido
Polished nickel

B 801/B



AF
Anticato
Antique finish



BSS
Bronzo scuro sfumato
Shaded dark bronze

coordinati per finestra
window complements

vis 805V



394



800
maniglia su placca
handle on plate



classic

design:
Dnd technical division

made in italy

Ottone
Brass



vis 571/12



OLV
Lucido
Polished



OS
Satinato
Satin



OGH
Bronzo satinato opaco
Matt satin bronze



AB
Bronzato
Antique bronze

coordinati per finestra
window complements

vis 574V



570
maniglia su placca
handle on plate

fedora

design:
Dnd technical division

Ottone
Brass

made in italy



vis 530/12



PVD-BG | forte®
Oro antico lucido
Antique bright gold



PVD-SG | forte®
Oro antico satinato
Antique satin gold



OGH
Bronzo satinato opaco
Matt satin bronze



AB
Bronzato
Antique bronze

coordinati per finestra
window complements

vis 529V



fiore

design:
Dnd technical division

Ottone
Brass

made in italy



R 522



ORO
Placcato oro 24K
Gold plated 24K



OGH
Bronzo satinato opaco
Matt satin bronze



ONV
Nickel lucido
Polished nickel

coordinati per finestra
window complements

VIS 526V



525
maniglia su placca
handle on plate



fiorenza

design:
Dnd technical division
made in italy

Ottone
Brass



R 523



ORO
Placcato oro 24K
Gold plated 24K



OGH
Bronzo satinato opaco
Matt satin bronze



ONV
Nickel lucido
Polished nickel

coordinati per finestra
window complements

VS 521V



519
maniglia su placca
handle on plate

airone

Ottone / Brass



vis 603/12

design:
Mauro Ronchi

made in italy

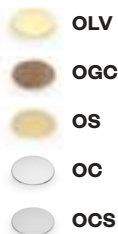

beauty

Ottone / Brass



B 775/B

design: **Dnd**
technical division

made in italy

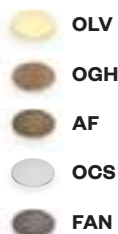

bruxelles

Ottone / Brass



vis 362/12

design: **Dnd**
technical division

made in italy

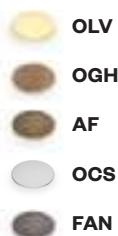

daniela

Ottone / Brass



VB 391/12

**design: Dnd
technical division**

made in italy



lorena

Ottone / Brass

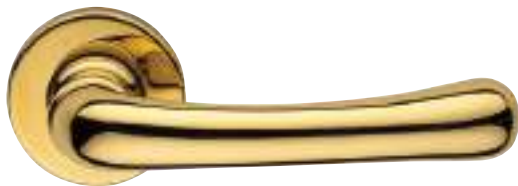

VB 251/12

**design: Dnd
technical division**

made in italy

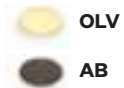

combinazioni particolari

—

combinations

Kit hotel maniglia-pomolo / *Knob-handle hotel kit*



**Principali soluzioni /
Main solutions**

Maniglia / handle **ARETÈ L 02**
Pomolo / knob **RING**

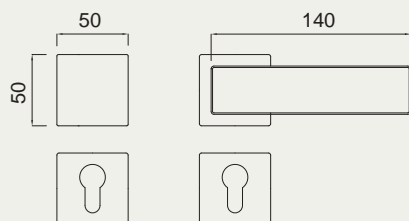

Maniglia / handle **CHANGE B 02**
Pomolo / knob **RING**

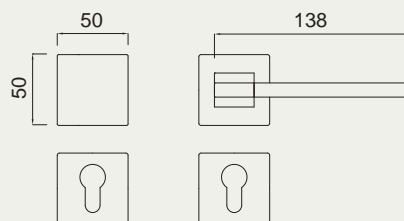

Maniglia / handle **EDRA 02**
Pomolo / knob **RING**

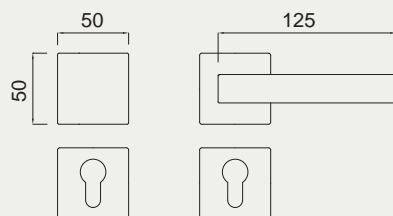

Maniglia / handle **LUXURY 02**
Pomolo / knob **RING**

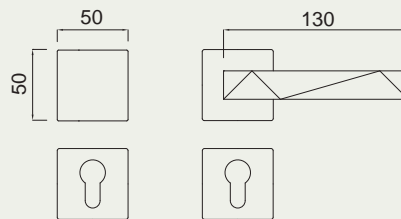

Maniglia / handle **QUATTRO 02**
Pomolo / knob **QUADRO**

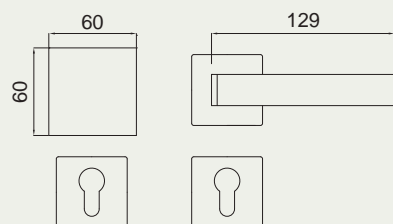

Kit hotel maniglia-pomolo / *Knob-handle hotel kit*



**Principali soluzioni /
Main solutions**

Maniglia / handle **TIMELESS**
Pomolo / knob **TIMELESS**

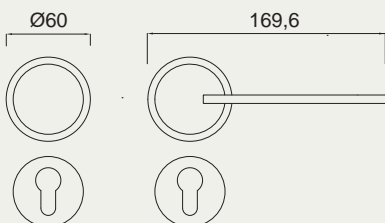

Maniglia / handle **LUCE**
Pomolo / knob **RONDÒ**

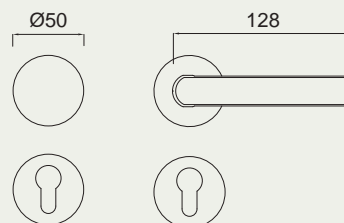

Maniglia / handle **CHOP**
Pomolo / knob **RONDÒ**

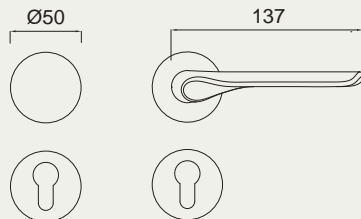

Maniglia / handle **SAFETY**
Pomolo / knob **RONDÒ**

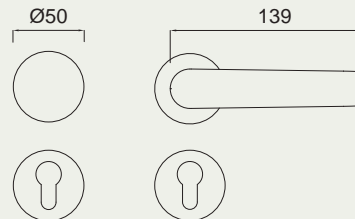

Maniglia / handle **SHORT**
Pomolo / knob **RONDÒ**

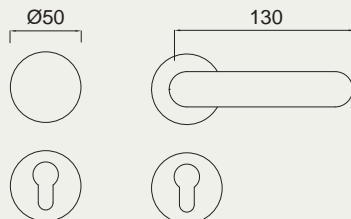

Maniglia / handle **ART**
Pomolo / knob **RONDÒ**

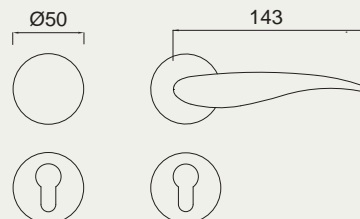

– pull

maniglioni

handles

pod

design:
Holscher Design

Ottone
Brass

made in italy



PVD-BG | forte®
Oro antico lucido
Antique bright gold



PVD-SG | forte®
Oro antico satinato
Antique satin gold



PVD-BB | forte® new
Bronzo lucido
Bright bronze



PVD-SB | forte® new
Bronzo satinato
Satin bronze



PGS | forte®
Grafite satinato
Satin graphite



OC
Cromo lucido
Polished chrome



OCS
Cromo satinato
Satin chrome



ONO
Nero
Black

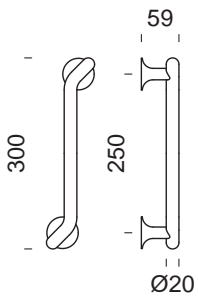

PD27 - singolo
PD28 - set



zeppelin

design:
Jaime Hayon

Ottone
Brass

made in italy

 **PVD-BG | forte®**
Oro antico lucido
Antique bright gold

 **PVD-SG | forte®**
Oro antico satinato
Antique satin gold

 **PVD-SCB | forte®**
Rame satinato
Satin copper

 **PVN | forte® new**
Nickel lucido
Bright nickel

 **PGS | forte®**
Grafite satinato
Satin graphite

 **OC new**
Cromo lucido
Polished chrome

 **OCS new**
Cromo satinato
Satin chrome

 **OVE**
Verde
Green

 **ONO**
Nero
Black

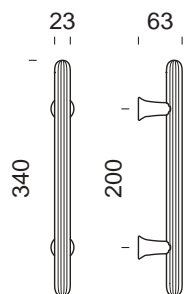

ZP27 - singolo
ZP28 - set

maniglione personalizzabile
customizable pull handle



(IN)finito

design:
Alfonso Femia

Ottone
Brass

made in italy



PVD-BB | forte® new
Bronzo lucido
Bright bronze



PVD-SB | forte® new
Bronzo satinato
Satin bronze



PGS | forte® new
Grafite satinato
Satin graphite



OLV
Lucido
Polished



SO
Sabbato opaco
Matt sandblasted



AB
Bronzato
Antique bronze



OC new
Cromo lucido
Polished chrome



OCS
Cromo satinato
Satin chrome



ONO
Nero
Black

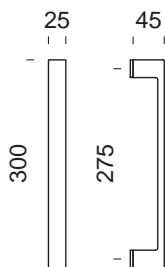

IF27 - singolo
IF28 - set



(IN)finito

design:
Alfonso Femia

Ottone
Brass

made in italy



PVD-BB | forte® new *
Bronzo lucido
Bright bronze



PVD-SB | forte® new *
Bronzo satinato
Satin bronze



PGS | forte® new *
Grafite satinato
Satin graphite



OLV
Lucido
Polished



SO
Sabbiato opaco
Matt sandblasted



AB
Bronzato
Antique bronze



OC new
Cromo lucido
Polished chrome



OCS
Cromo satinato
Satin chrome



ONO
Nero
Black

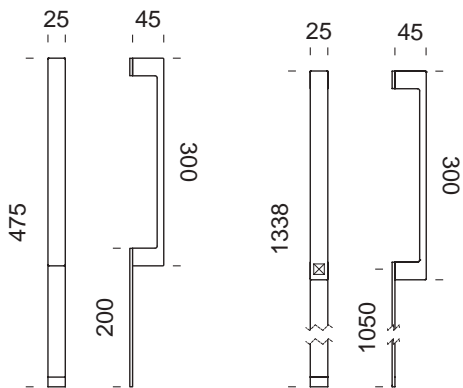

IF29 - singolo
IF30 - set

IF31 - singolo
IF32 - set

* finiture disponibili solo su placca corta
finishes available only on short plate



maniglione personalizzabile
customizable pull handle

eleonora

design:
Marco Pisati

Ottone
Brass

made in italy



PVD-BG | forte®
Oro antico lucido
Antique bright gold



PVD-SG | forte®
Oro antico satinato
Antique satin gold



PVN | forte® new
Nickel lucido
Bright nickel



PGS | forte®
Grafite satinato
Satin graphite



OGH
Bronzo satinato opaco
Matt satin bronze



OC new
Cromo lucido
Polished chrome



OCS new
Cromo satinato
Satin chrome

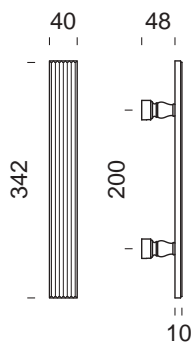

EL27 - singolo
EL28 - set

maniglione personalizzabile
customizable pull handle

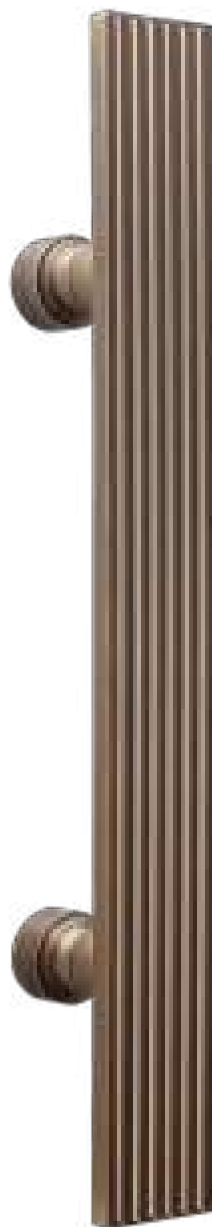

eleonora

design:
Marco Pisati

Ottone
Brass

made in italy



PVD-BG | forte®
Oro antico lucido
Antique bright gold



PVD-SG | forte®
Oro antico satinato
Antique satin gold



PVN | forte® new
Nickel lucido
Bright nickel



PGS | forte®
Grafite satinato
Satin graphite



OGH
Bronzo satinato opaco
Matt satin bronze



OC new
Cromo lucido
Polished chrome



OCS new
Cromo satinato
Satin chrome

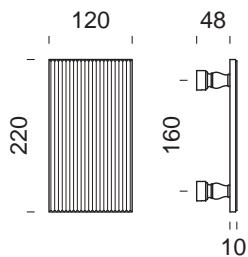

EL29 - singolo
EL30 - set

maniglione personalizzabile
customizable pull handle

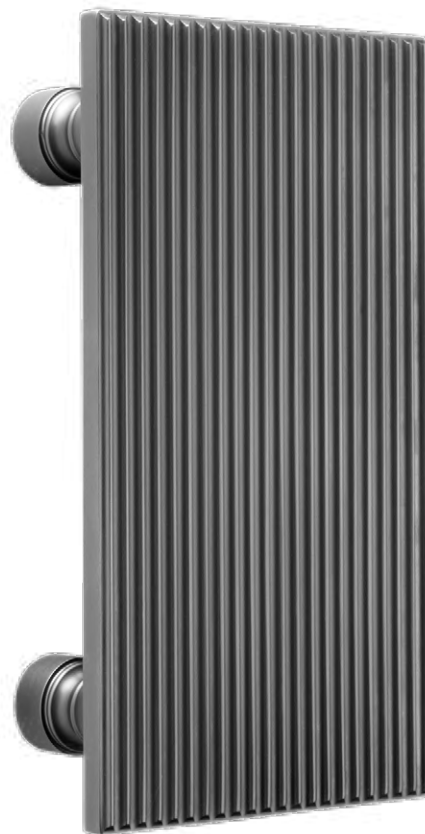

eleonora NEW

design:
Marco Pisati

Ottone
Brass

made in italy



PVD-BG | forte®
Oro antico lucido
Antique bright gold



PVD-SG | forte®
Oro antico satinato
Antique satin gold



PVN | forte® new
Nickel lucido
Bright nickel



PGS | forte®
Grafite satinato
Satin graphite



OGH
Bronzo satinato opaco
Matt satin bronze



OC new
Cromo lucido
Polished chrome



OCS new
Cromo satinato
Satin chrome

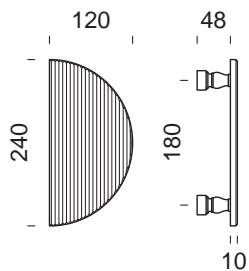
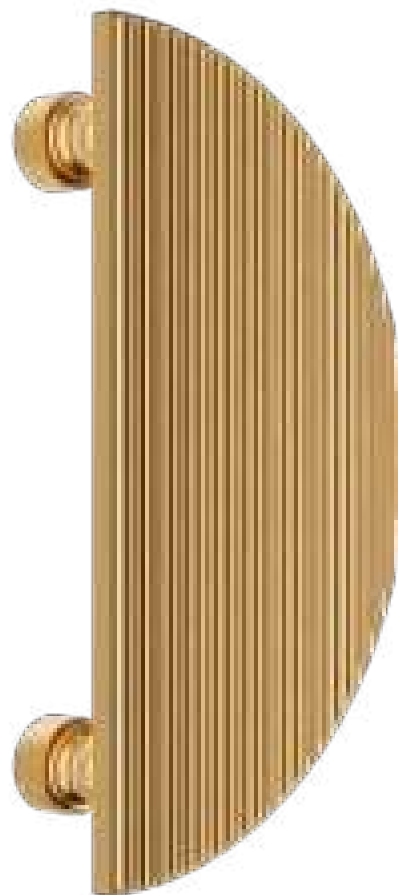

EL31 - singolo
EL32 - set

lucrezia

design:
Marco Pisati

Ottone
Brass

made in italy



PVD-BG | forte®
Oro antico lucido
Antique bright gold



PVD-SG | forte®
Oro antico satinato
Antique satin gold



PVN | forte® new
Nickel lucido
Bright nickel



PGS | forte®
Grafite satinato
Satin graphite



OGH
Bronzo satinato opaco
Matt satin bronze



OC new
Cromo lucido
Polished chrome



OCS new
Cromo satinato
Satin chrome

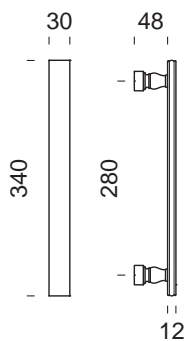

LT27 - singolo
LT28 - set

maniglione personalizzabile
customizable pull handle

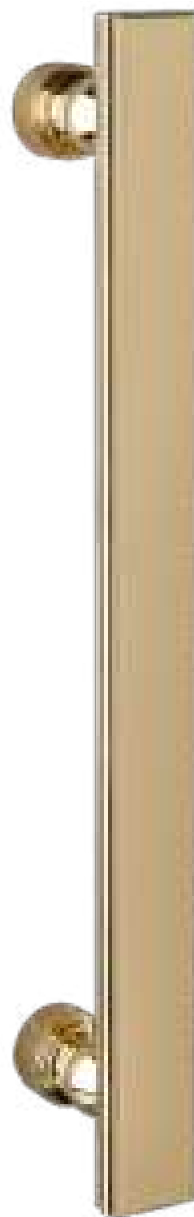

ginkgo

design:
Giulio Iacchetti

Ottone
Brass

made in italy



PVD-BG | forte®
Oro antico lucido
Antique bright gold



ONO
Nero
Black



PVD-SG | forte®
Oro antico satinato
Antique satin gold



PVD-SH | forte® new
Oro champagne satinato
Champagne satin gold



PVD-BB | forte® new
Bronzo lucido
Bright bronze



PVD-SB | forte® new
Bronzo satinato
Satin bronze



PVN | forte® new
Nickel lucido
Bright nickel



PGS | forte®
Grafite satinato
Satin graphite



OC
Cromo lucido
Polished chrome



OCS
Cromo satinato
Satin chrome

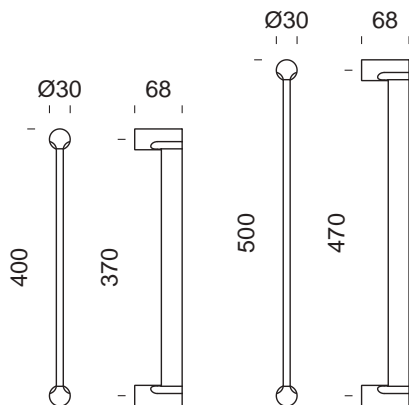

GK27 - singolo (400 mm)

GK28 - set (400 mm)

GK29 - singolo (500 mm)

GK30 - set (500 mm)

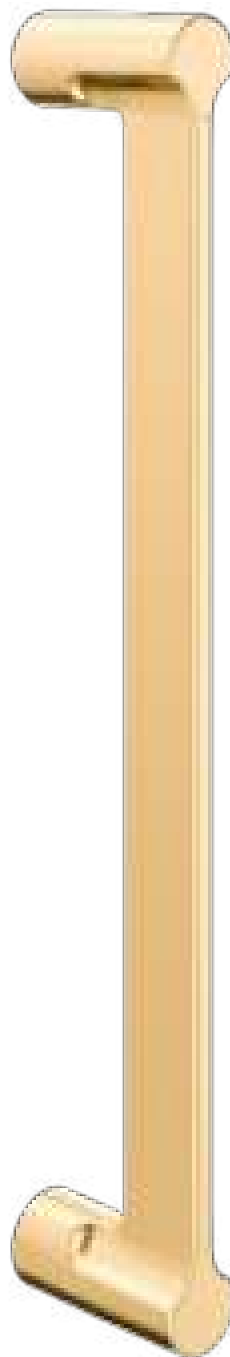

maniglione personalizzabile
customizable pull handle

ginkgo biloba

design:
Giulio lacchetti

Ottone
Brass

made in italy



PVD-BG | forte®
Oro antico lucido
Antique bright gold



ONO
Nero
Black



PVD-SG | forte®
Oro antico satinato
Antique satin gold



PVD-SH | forte® new
Oro champagne satinato
Champagne satin gold



PVD-BB | forte® new
Bronzo lucido
Bright bronze



PVD-SB | forte® new
Bronzo satinato
Satin bronze



PVN | forte® new
Nickel lucido
Bright nickel



PGS | forte®
Grafite satinato
Satin graphite



OC
Cromo lucido
Polished chrome



OCS
Cromo satinato
Satin chrome

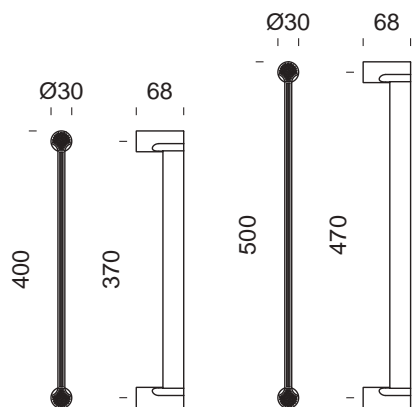

GB27 - singolo (400 mm)

GB28 - set (400 mm)

GB29 - singolo (500 mm)

GB30 - set (500 mm)

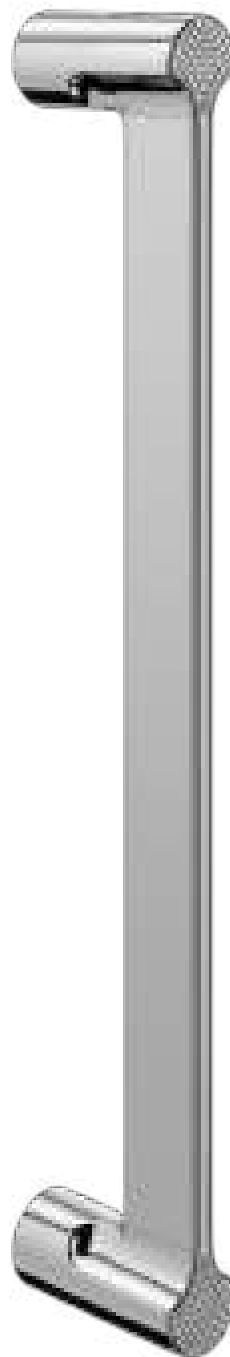

maniglione personalizzabile
customizable pull handle

aretè

design:
Mauro Ronchi

Ottone
Brass

made in italy



PVD-SG | forte®
Oro antico satinato
Antique satin gold



PVX | forte®
Inox satinato
Satin steel



PGS | forte®
Grafite satinato
Satin graphite



OGH
Bronzo satinato opaco
Matt satin bronze



AB
Bronzato
Antique bronze



OC
Cromo lucido
Polished chrome



OCS
Cromo satinato
Satin chrome

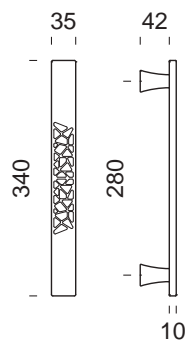

AT27 - singolo
AT28 - set

maniglione personalizzabile
customizable pull handle



aretè L

design:
Mauro Ronchi

Ottone
Brass

made in italy



PVD-SG | forte®
Oro antico satinato
Antique satin gold



PVX | forte®
Inox satinato
Satin steel



PGS | forte®
Grafite satinato
Satin graphite



OGH
Bronzo satinato opaco
Matt satin bronze



AB
Bronzato
Antique bronze



OC
Cromo lucido
Polished chrome



OCS
Cromo satinato
Satin chrome

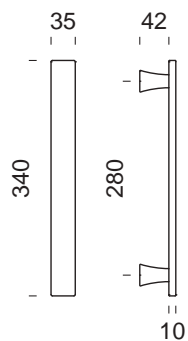

AL27 - singolo
AL28 - set

maniglione personalizzabile
customizable pull handle



cloe

design:
Dnd technical division

Ottone
Brass

made in italy



PGS | forte®
Grafite satinato
Satin graphite



OC
Cromo lucido
Polished chrome



OCS
Cromo satinato
Satin chrome

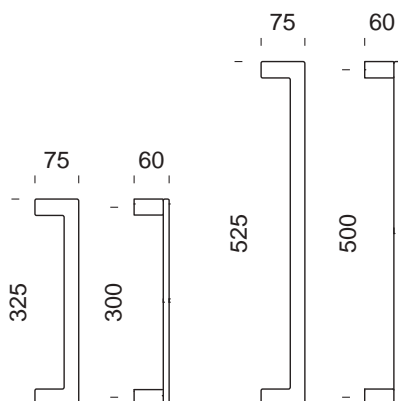

CL27 - singolo (300 mm)

CL28 - set (300 mm)

CL29 - singolo (500 mm)

CL30 - set (500 mm)

maniglione personalizzabile
customizable pull handle

domus

design:
Dnd technical division

Ottone
Brass

made in italy



OLV
Lucido
Polished



OCS
Cromo satinato
Satin chrome



OGH
Bronzo satinato opaco
Matt satin bronze

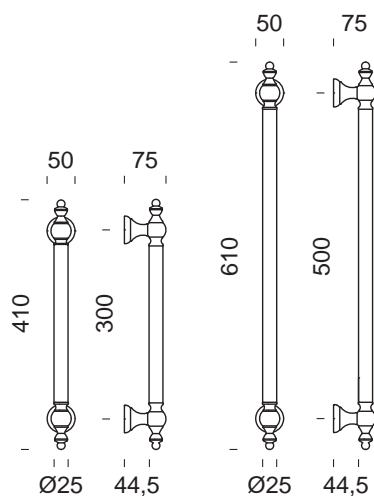

DO27/300 - singolo
DO26/300 - set

DO27/500 - singolo
DO26/500 - set



maniglione personalizzabile
customizable pull handle

solid square

design:
Dnd technical division

Ottone
Brass

made in italy



PGS | forte®
Grafite satinato
Satin graphite



OC
Cromo lucido
Polished chrome



OCS
Cromo satinato
Satin chrome



ONO
Nero
Black

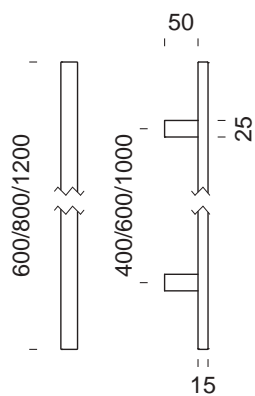

singolo

SQ400
SQ600
SQ1000

set

SQ401
SQ601
SQ1001



maniglione personalizzabile
customizable pull handle

tube round

design:
Dnd technical division

Ottone
Brass

made in italy



PVD-SG | forte®
Oro antico satinato
Antique satin gold



PGS | forte®
Grafite satinato
Satin graphite



OCS
Cromo satinato
Satin chrome



ONO
Nero
Black

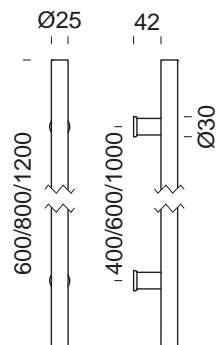

singolo

TR400

TR600

TR1000

set

TR401

TR601

TR1001



maniglione personalizzabile
customizable pull handle

tube round zancato NEW

design:
Dnd technical division

Ottone
Brass

made in italy

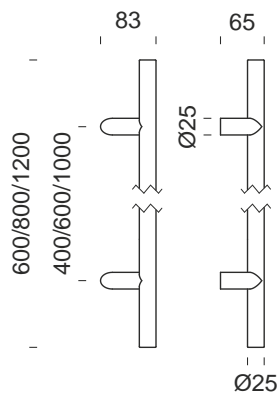

singolo
TZ400
TZ600
TZ1000

set
TZ401
TZ601
TZ1001



maniglione personalizzabile
customizable pull handle

luxury

design:
Mauro Ronchi

Ottone
Brass

made in italy



PVD-BG | forte®
Oro antico lucido
Antique bright gold



PVD-SG | forte®
Oro antico satinato
Antique satin gold



PVD-SCB | forte®
Rame satinato
Satin copper



PGS | forte®
Grafite satinato
Satin graphite



OGH
Bronzo satinato opaco
Matt satin bronze



OC
Cromo lucido
Polished chrome



OCS
Cromo satinato
Satin chrome



ONO
Nero
Black

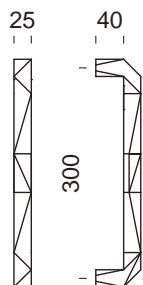

LU27 - singolo
LU28 - set



C-1918

design:
Achille Castiglioni
Gianfranco Cavaglia

Acciaio inox AISI 316 + rame
AISI Stainless steel 316 + copper

made in italy



L316 + R

AISI 316 lucido + inserto rame PVD
AISI 316 polished + PVD copper insert



S316 + R

AISI 316 satinato + inserto rame PVD
AISI 316 satin + PVD copper insert



L316 + N

AISI 316 lucido + inserto rame nero
AISI 316 polished + black copper insert



S316 + N

AISI 316 satinato + inserto rame nero
AISI 316 satin + black copper insert

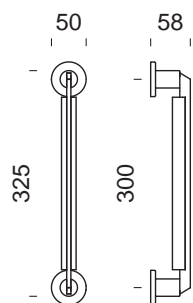

C-1918

CC25 - singolo
CC26 - set

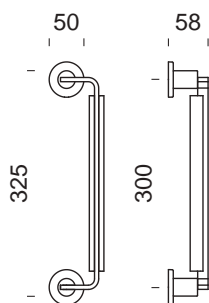

C-1918 zancato

CC27 - singolo
CC28 - set



logo

design:
Mauro Ronchi

Ottone
Brass

made in italy



PVX | forte®
Inox satinato
Satin steel



OC
Cromo lucido
Polished chrome



OCS
Cromo satinato
Satin chrome



ONS
Nickel satinato
Satin nickel

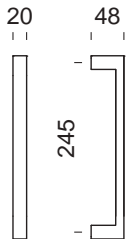

LO25 - singolo
LO26 - set

linear

design:
Mauro Ronchi

Ottone
Brass

made in italy



PVD-BG | forte®
Oro antico lucido
Antique bright gold



PVD-SG | forte®
Oro antico satinato
Antique satin gold



OGH
Bronzo satinato opaco
Matt satin bronze



OC
Cromo lucido
Polished chrome



OCS
Cromo satinato
Satin chrome

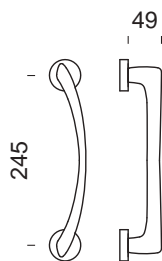

LI25 - singolo
LI26 - set

project

design:
Dnd technical division

Ottone
Brass

made in italy



OC
Cromo lucido
Polished chrome



OCS
Cromo satinato
Satin chrome



ONS
Nickel satinato
Satin nickel

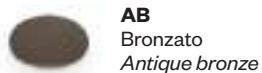

AB
Bronzato
Antique bronze



ONO
Nero
Black

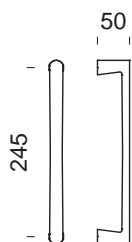

project

PR29 - singolo
PR26 - set

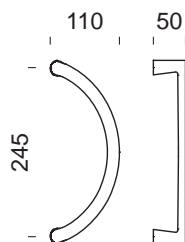

project spostato

PR27 - singolo
PR28 - set



art

design:
Mauro Ronchi

Ottone
Brass

made in italy



OC
Cromo lucido
Polished chrome



OCS
Cromo satinato
Satin chrome



OGH
Bronzo satinato opaco
Matt satin bronze

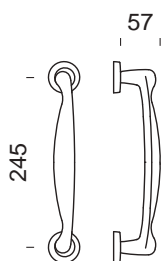

AR25 - singolo
AR26 - set

intake

design:
Andrea Morgante

Ottone
Brass

made in italy



OC
Cromo lucido
Polished chrome



**Altre finiture disponibili
su richiesta.**

*Other finishes available
on demand.*

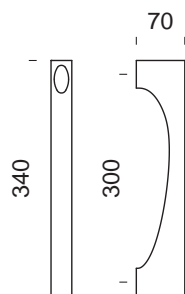

IN25 - singolo
IN26 - set

fluke

design:
Karim Rashid

Ottone
Brass

made in italy



PVD-BG | forte® new
Oro antico lucido
Antique bright gold



PVD-SG | forte® new
Oro antico satinato
Antique satin gold



PVD-SB | forte® new
Bronzo satinato
Satin bronze



PGS | forte® new
Grafite satinato
Satin graphite



OC
Cromo lucido
Polished chrome



OCS
Cromo satinato
Satin chrome

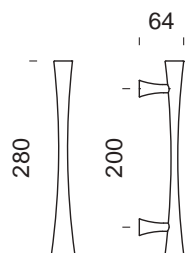

FK27 - singolo
FK28 - set



luce

design:
Dnd technical division

Zama
Zamak

made in italy



ZC
Cromo lucido
Polished chrome



ZCS
Cromo satinato
Satin chrome



ZNE
Nero
Black

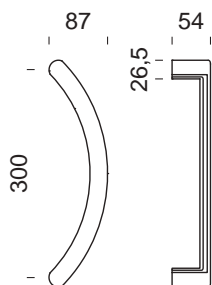

LC26 - singolo
LC28 - set

latina

design:
Mauro Ronchi

Ottone
Brass

made in italy



PVD | forte®
Oro lucido
Bright gold



OGH
Bronzo satinato opaco
Matt satin bronze



BSS
Bronzo scuro sfumato
Shaded dark bronze

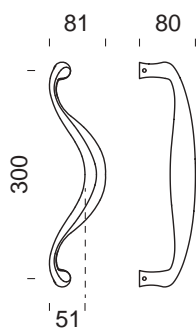

1110 - singolo
1111 - set

only

design:
Dnd technical division

Ottone
Brass

made in italy



OLV
Lucido
Polished



OCS
Cromo satinato
Satin chrome



OGH
Bronzo satinato opaco
Matt satin bronze



AF
Anticato
Antique finish

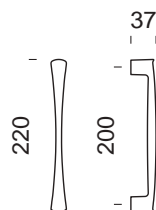

1165 - singolo
1166 - set

daniela

design:
Dnd technical division

Ottone
Brass

made in italy



ONV
Nickel lucido
Polished nickel



OLV
Lucido
Polished



FAN
Ferro anticato
Antique iron



AF
Anticato
Antique finish



AB
Bronzato
Antique bronze

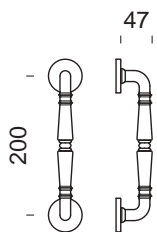

daniela
1150 - singolo

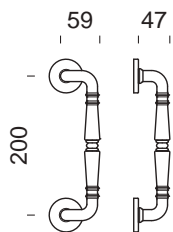

daniela spostato
1170 - singolo spostato

maniglioni

- pull handles
for lift

per alzante
scorrevole

sliding
system

edra 02

design:
Mauro Ronchi

Ottone
Brass

made in italy



PVD-SG | forte®
Oro antico satinato
Antique satin gold



ONO
Nero
Black



PVD-SCB | forte®
Rame satinato
Satin copper



PGS | forte®
Grafite satinato
Satin graphite



PVX | forte®
Inox satinato
Satin steel



OC
Cromo lucido
Polished chrome



OCS
Cromo satinato
Satin chrome



ONS
Nickel satinato
Satin nickel



OGH
Bronzo satinato opaco
Matt satin bronze

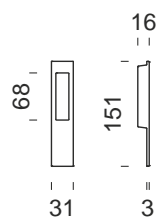
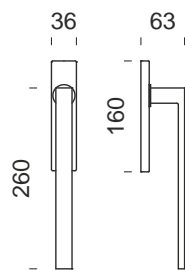

ED60 - singolo
ED61 - set



edra 02 corto

design:
Mauro Ronchi

Ottone
Brass

made in italy

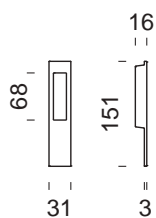
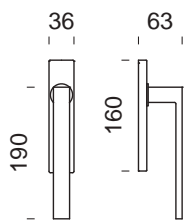
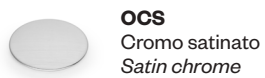

ED63A - singolo
ED64 - set

edra

design:
Mauro Ronchi

Ottone
Brass

made in italy



PVD-SG | forte®
Oro antico satinato
Antique satin gold



ONO
Nero
Black



PVD-SCB | forte®
Rame satinato
Satin copper



PGS | forte®
Grafite satinato
Satin graphite



PVX | forte®
Inox satinato
Satin steel



OC
Cromo lucido
Polished chrome



OCS
Cromo satinato
Satin chrome



ONS
Nickel satinato
Satin nickel



OGH
Bronzo satinato opaco
Matt satin bronze

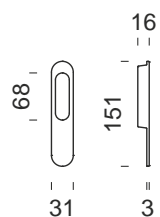
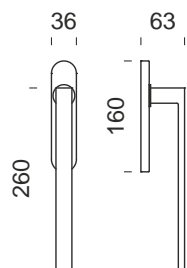

ED50 - singolo
ED51 - set



edra corto

design:
Mauro Ronchi

Ottone
Brass

made in italy



OC
Cromo lucido
Polished chrome



OCS
Cromo satinato
Satin chrome

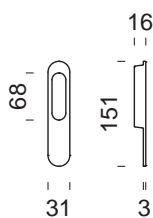
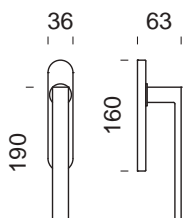

ED53 - singolo
ED54 - set

slide

design:
Mauro Ronchi

Ottone
Brass

made in italy



PVD-BG | forte®
Oro antico lucido
Antique bright gold



PVD-SG | forte®
Oro antico satinato
Antique satin gold



PVD-SH | forte® new
Oro champagne satinato
Champagne satin gold



PVD-BB | forte® new
Bronzo lucido
Bright bronze



PVD-SB | forte® new
Bronzo satinato
Satin bronze



PVN | forte® new
Nickel lucido
Bright nickel



PGS | forte®
Grafite satinato
Satin graphite



OC
Cromo lucido
Polished chrome



OCS
Cromo satinato
Satin chrome



ONS
Nickel satinato
Satin nickel



OLV
Lucido
Polished

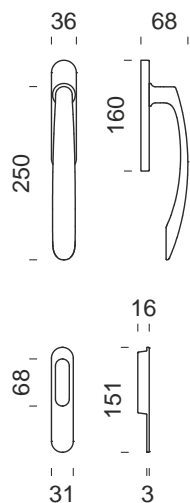

1120 - singolo
1121 - set

slide corto

design:
Mauro Ronchi

Ottone
Brass

made in italy



OC
Cromo lucido
Polished chrome



OCS
Cromo satinato
Satin chrome



OLV
Lucido
Polished

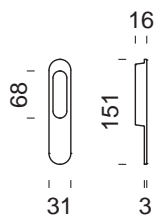
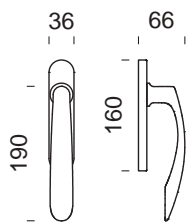

1125 - singolo
1126 - set
1127 - DK

luce p NEW

design:
Dnd technical division

Zama
Zamak

made in italy



ZC
Cromo lucido
Polished chrome



ZCS
Cromo satinato
Satin chrome



ZNS
Nickel satinato
Satin nickel



ZGH
Bronzo satinato opaco
Matt satin bronze



ZAN
Antracite
Anthracite



ZNE
Nero
Black

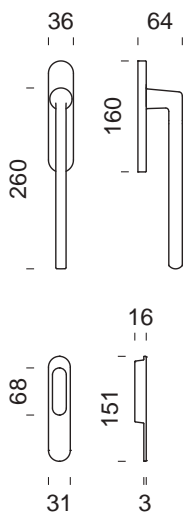

LP50 - singolo
LP51 - set

luce p 02 NEW

design:
Dnd technical division

Zama
Zamak

made in italy



ZC
Cromo lucido
Polished chrome



ZCS
Cromo satinato
Satin chrome



ZNS
Nickel satinato
Satin nickel



ZGH
Bronzo satinato opaco
Matt satin bronze



ZAN
Antracite
Anthracite



ZNE
Nero
Black

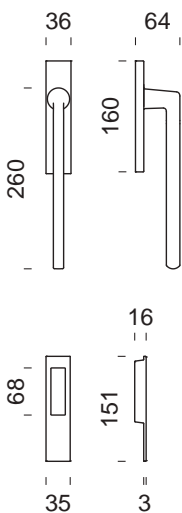

LP60 - singolo
LP61 - set



luce

design:
Dnd technical division

Zama
Zamak

made in italy



ZC
Cromo lucido
Polished chrome



ZCS
Cromo satinato
Satin chrome



ZNS
Nickel satinato
Satin nickel



ZGH
Bronzo satinato opaco
Matt satin bronze



ZAN
Antracite
Anthracite



ZNE
Nero
Black

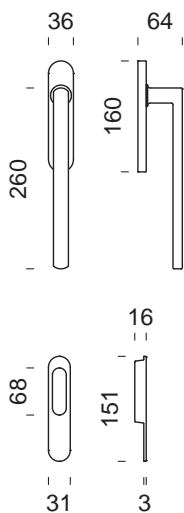

LC50 - singolo
LC51 - set



luce 02

design:
Dnd technical division

Zama
Zamak

made in italy



ZC
Cromo lucido
Polished chrome



ZCS
Cromo satinato
Satin chrome



ZNS
Nickel satinato
Satin nickel



ZGH
Bronzo satinato opaco
Matt satin bronze



ZAN
Antracite
Anthracite



ZNE
Nero
Black

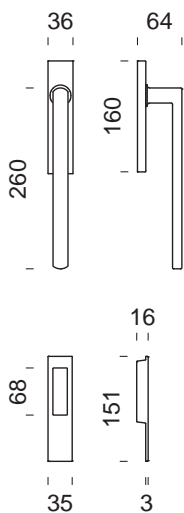

LC60 - singolo
LC61 - set



liter

design:
Dnd technical division

Ottone
Brass

made in italy



OCS
Cromo satinato
Satin chrome



ONO new
Nero
Black

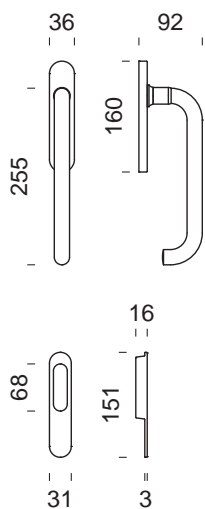

1130 - singolo
1131 - set



placche incasso

Ottone
Brass



PGF | forte®
Grafite satinato
Satin graphite



OC
Cromo lucido
Polished chrome



OCS
Cromo satinato
Satin chrome



ONS
Nickel satinato
Satin nickel



OLV
Lucido
Polished



OGH
Bronzo satinato opaco
Matt satin bronze



TAN
Antracite
Anthracite



ONO
Nero
Black

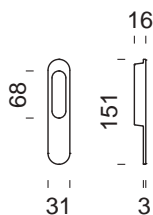

1122

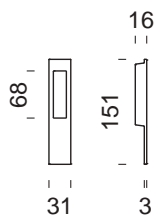

ED66

– knobs

pomoli

ring

design:
Dnd technical division

made in italy

Ottone
Brass

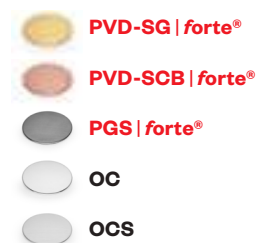

VIS RI39 - singolo
RI35 - set

rondò

design:
Dnd technical division

made in italy

Ottone
Brass

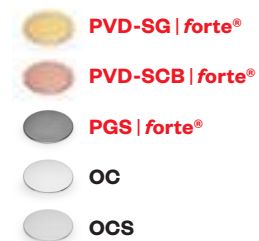
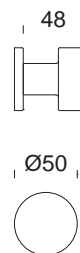

VIS RO43 - singolo
RO44 - set



RO39 - singolo
RO36 - set

quadro

design:
Dnd technical division

made in italy

Ottone
Brass

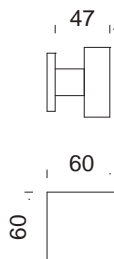
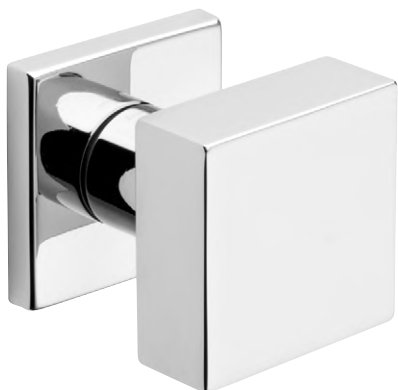

VIS 1575 - singolo

timeless

design:
Marco Pisati

made in italy

Alluminio
Aluminium

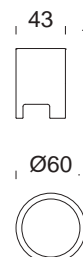

FINE TL39 - singolo
TL40 - set

sfera

design:
Dnd technical division

made in italy

Ottone
Brass



1570/1 - singolo

lucrezia

design:
Marco Pisati

made in italy

Ottone
Brass

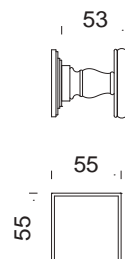

R LT39 - singolo
LT35 - set

FINE LT48 - singolo
LT44 - set

lucrezia 02

design:
Marco Pisati

made in italy

Ottone
Brass



R LT42 - singolo
LT36 - set



FINE LT49 - singolo
LT45 - set

lucrezia 03

design:
Marco Pisati

made in italy

Ottone
Brass



R LT38 - singolo
LT34 - set



FINE LT47 - singolo
LT43 - set

fiorenza

design:
Dnd technical division

made in italy

Ottone
Brass

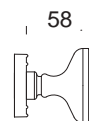

1520 - singolo

1521 - set

easy

design:
Dnd technical division

made in italy

Ottone
Brass

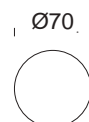

1560 - singolo

project

design:
Dnd technical division
made in italy

Ottone
Brass

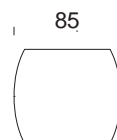

VIS PR35 - singolo

VIS PR36 - singolo

pomolini per mobili *furniture knobs*

crisalide NEW

design:
Elena Salmistraro

made in italy

Alluminio + porcellana
Aluminium + porcelain

appendino
hanger



CS70

ANE + PSW

Nero + porcellana lucida bianca
Black + white glossy porcelain

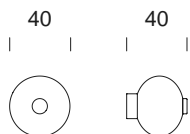

CS71

ANE + PSD

Nero + porcellana lucida decorata
Black + decorated glossy porcelain

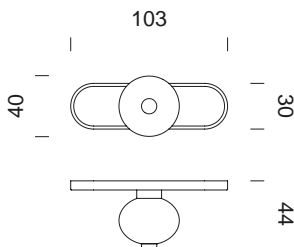

CS72

ANE + PSD

Nero + porcellana lucida decorata
Black + decorated glossy porcelain

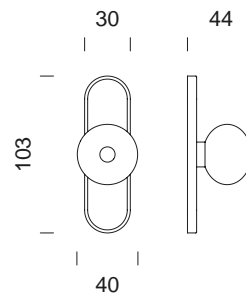

dune NEW



DN70

PVD-SG | forte® + PSB

39



37



design:
Elena Salmistraro

made in italy

Ottone + porcellana
Brass + porcelain



PVD-BG | forte® + PSB

Oro antico lucido + porcellana
lucida bianco sabbia
*Antique bright gold + sand-white
glossy porcelain*



PVD-BG | forte® + PSR

Oro antico lucido + porcellana
lucida rosa nuvola
*Antique bright gold + cloud-pink
glossy porcelain*



PVD-BG | forte® + PSV

Oro antico lucido + porcellana
lucida verde menta
*Antique bright gold + mint-green
glossy porcelain*



PVD-SG | forte® + PSB

Oro antico satinato + porcellana
lucida bianco sabbia
*Antique satin gold + sand-white
glossy porcelain*



PVD-SG | forte® + PSR

Oro antico satinato + porcellana
lucida rosa nuvola
*Antique satin gold + cloud-pink
glossy porcelain*



PVD-SG | forte® + PSV

Oro antico satinato + porcellana
lucida verde menta
*Antique satin gold + mint-green
glossy porcelain*



PVD-SCB | forte® + PSB

Rame satinato + porcellana
lucida bianco sabbia
*Satin copper + sand-white
glossy porcelain*



PVD-SCB | forte® + PSR

Rame satinato + porcellana
lucida rosa nuvola
*Satin copper + cloud-pink
glossy porcelain*



PVD-SCB | forte® + PSV

Rame satinato + porcellana
lucida verde menta
*Satin copper + mint-green
glossy porcelain*



OBN + PSB new

Bianco + porcellana lucida
bianco sabbia
*White + sand-white glossy
porcelain*



OBN + PSR new

Bianco + porcellana lucida
rosa nuvola
*White + cloud-pink glossy
porcelain*



OBN + PSV new

Bianco + porcellana lucida
verde menta
*White + mint-green glossy
porcelain*



ONO + PSB

Nero + porcellana lucida
bianco sabbia
*Black + sand-white glossy
porcelain*



ONO + PSR

Nero + porcellana lucida
rosa nuvola
*Black + cloud-pink glossy
porcelain*



ONO + PSV

Nero + porcellana lucida
verde menta
*Black + mint-green glossy
porcelain*

pomolini per mobili

furniture knobs



Alluminio
Aluminium

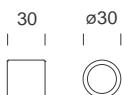

timeless
design: **Marco Pisati**

TL70
mm. 30



Ottone
Brass

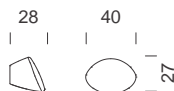

art
ART40



Ottone
Brass



fluò
FL40



Ottone
Brass



go
GO40

accessori per mobili

furniture accessories

Ottone
Brass

design:
Marco Pisati

made in italy



lucrezia
LT80

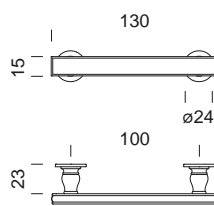

lucrezia
LT70



maniglie

– sliding
door

per porte
scorrevoli

handles

master tonda NEW

design:
Dnd technical division

made in italy

Ottone
Brass

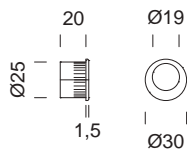

2191
frontale per scorrevole
*sliding door flush
pull hole*

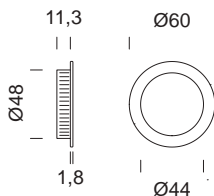

SD500
maniglia incasso
sliding door handle

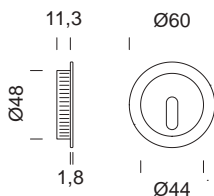

SD500P
maniglia incasso
foro chiave
*sliding door handle
key hole*

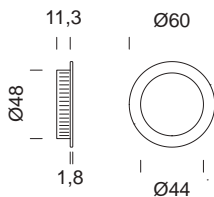
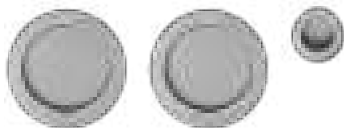

SD501
set maniglie incasso
con frontale
*sliding door handle set
with flush pull hole*

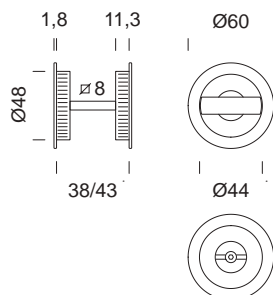
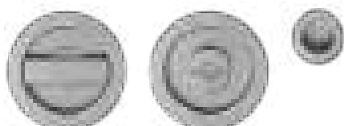

SD503M
set maniglie incasso con
nottolino q. 8 mm con
frontale
*sliding door handle set with
turn and release 8 mm
square spindle and flush
pull hole*



Su richiesta disponibile in tutte le finiture elencate a catalogo
On demand available in all finishes of Dnd catalogue

master tonda NEW

design:
Dnd technical division

made in italy

Ottone
Brass

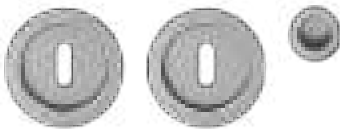

SD505

set maniglie incasso foro chiave con frontale + serratura

sliding door handle set key hole with flush pull hole + lock

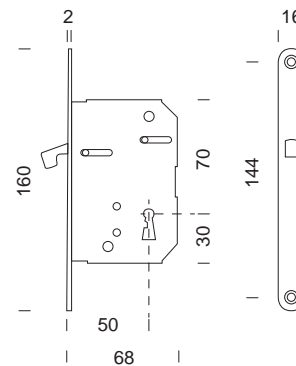
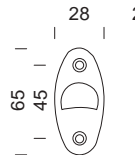
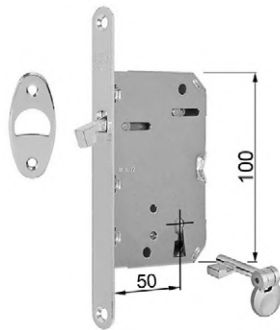

SE107

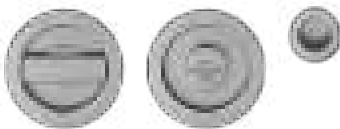

SD506M

set maniglie incasso con nottolino q.8 mm con frontale + serratura

sliding door handle set with turn and release 8 mm square spindle with flush pull hole + lock

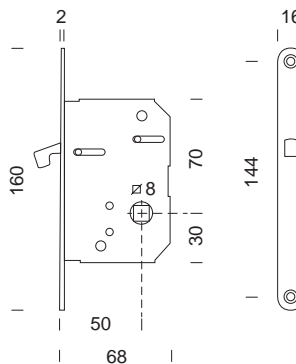
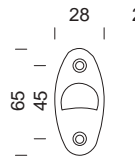

SE108

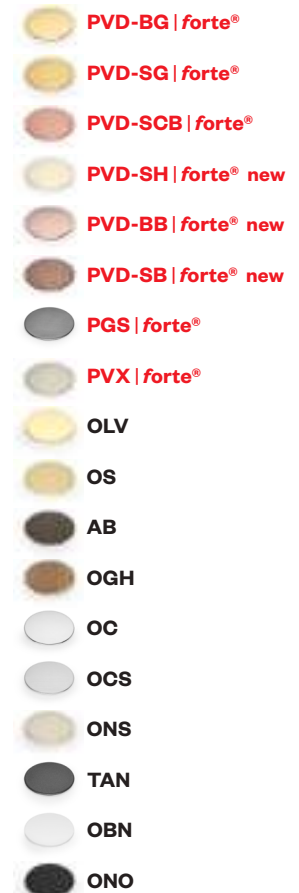

Su richiesta disponibile in tutte le finiture elencate a catalogo
On demand available in all finishes of Dnd catalogue

master quadra NEW

design:
Dnd technical division

made in italy

Ottone
Brass

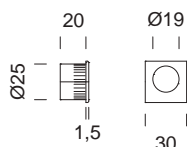

2189
frontale per scorrevole
*sliding door flush
pull hole*

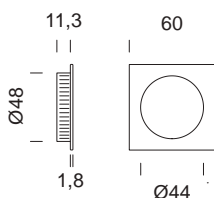

SD520
maniglia incasso
sliding door handle

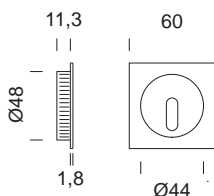

SD520P
maniglia incasso
foro chiave
*sliding door handle
key hole*

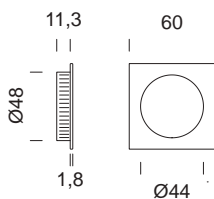

SD521
set maniglie incasso
con frontale
*sliding door handle set with flush
pull hole*

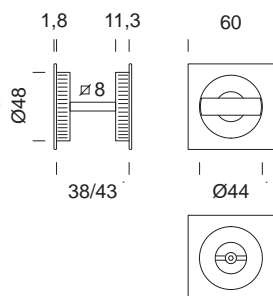

SD523M
set maniglie incasso con
nottolino q. 8 mm con
frontale
*sliding door handle set with turn
and release
8 mm square
spindle and flush
pull hole*

- PVD-BG | forte®**
- PVD-SG | forte®**
- PVD-SCB | forte®**
- PVD-SH | forte® new**
- PVD-BB | forte® new**
- PVD-SB | forte® new**
- PGS | forte®**
- PVX | forte®**
- OS**
- AB**
- OGH**
- OC**
- OCS**
- ONS**
- TAN**
- OBN**
- ONO**

Su richiesta disponibile in tutte le finiture elencate a catalogo
On demand available in all finishes of Dnd catalogue

master quadra NEW

design:
Dnd technical division

made in italy

Ottone
Brass

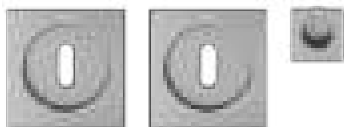

SD525

set maniglie incasso foro chiave con frontale + serratura

sliding door handle set key hole with flush pull hole + lock

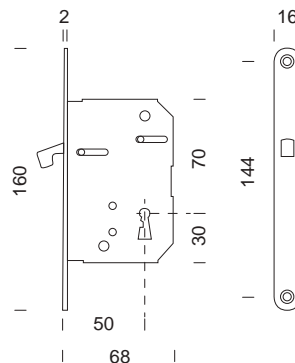
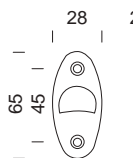
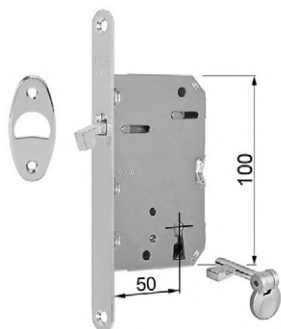

SE107

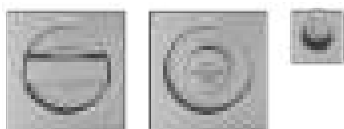

SD526M

set maniglie incasso con nottolino q.8 mm con frontale + serratura

sliding door handle set with turn and release 8 mm square spindle with flush pull hole + lock

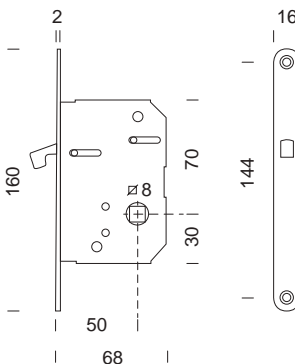
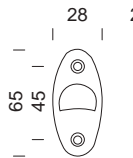

SE108



Su richiesta disponibile in tutte le finiture elencate a catalogo
On demand available in all finishes of Dnd catalogue

ginkgo tonda

Ottone e zama
Brass and zamak

design:
Giulio lacchetti

made in italy

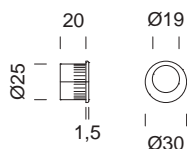

2191
frontale per scorrevole
*sliding door flush
pull hole*

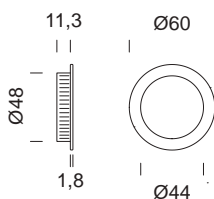

SD500
maniglia incasso
sliding door handle

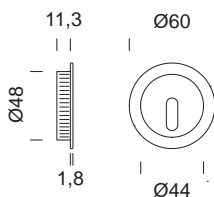

SD500P
maniglia incasso
foro chiave
*sliding door handle
key hole*

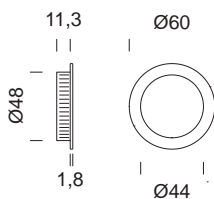

SD501
set maniglie incasso
con frontale
*sliding door handle set
with flush pull hole*

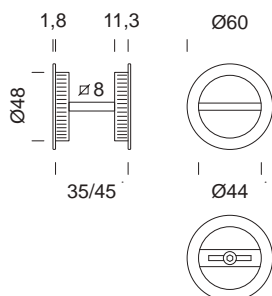

SD503
set maniglie incasso con
nottolino q. 8 mm. con
frontale
*sliding door handle set with
turn and release 8 mm
square spindle and flush
pull hole*

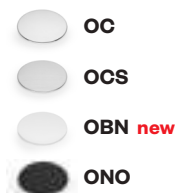

ginkgo tonda

Ottone e zama
Brass and zamak

design:
Giulio lacchetti

made in italy



SD505

set maniglie incasso foro chiave con frontale + serratura

sliding door handle set key hole with flush pull hole + lock

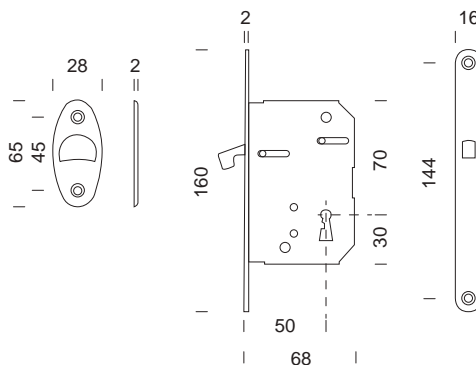

SE107



SD506

set maniglie incasso con nottolino q. 8 mm con frontale + serratura

sliding door handle set with turn and release 8 mm square spindle with flush pull hole + lock

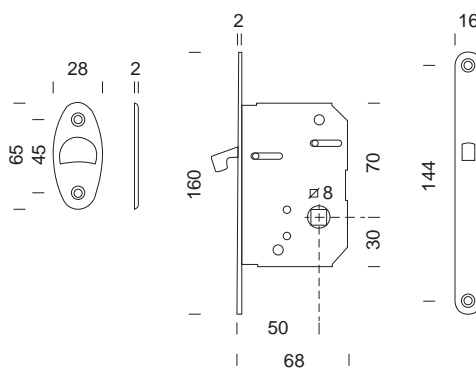

SE108

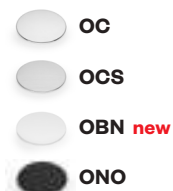

ginkgo quadra

Ottone e zama
Brass and zamak

design:
Giulio lacchetti

made in italy

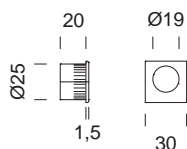

2189
frontale per scorrevole
*sliding door flush
pull hole*

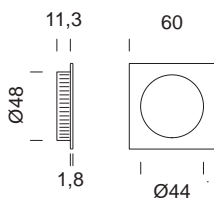

SD520
maniglia incasso
sliding door handle

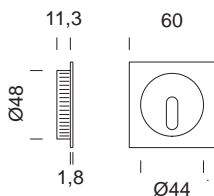

SD520P
maniglia incasso
foro chiave
*sliding door handle
key hole*

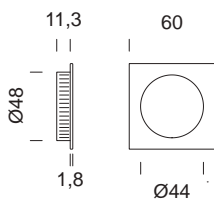

SD521
set maniglie incasso
con frontale
*sliding door handle set
with flush pull hole*

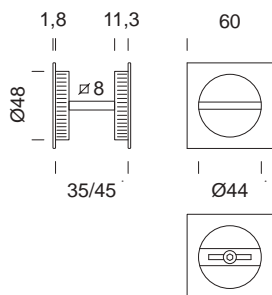

SD523
set maniglie incasso con
nottolino q.8 mm. con
frontale
*sliding door handle set with
turn and release 8 mm
square spindle and flush
pull hole*



ginkgo quadra

Ottone e zama
Brass and zamak

design:
Giulio lacchetti

made in italy



SD525

set maniglie incasso foro chiave con frontale + serratura

sliding door handle set key hole with flush pull hole + lock

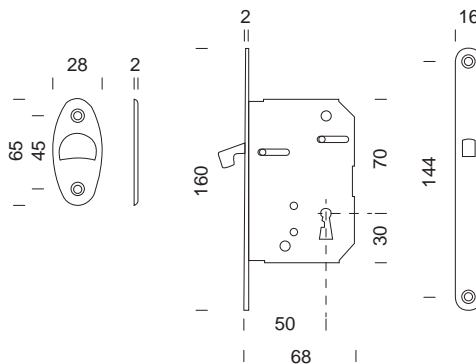
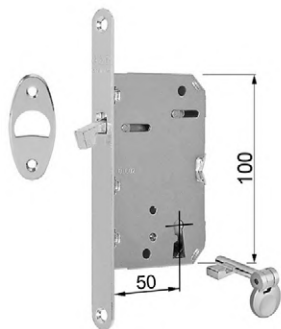

SE107



SD526

set maniglie incasso con nottolino q.8 mm con frontale +serratura

sliding door handle set with turn and release 8 mm square spindle with flush pull hole + lock

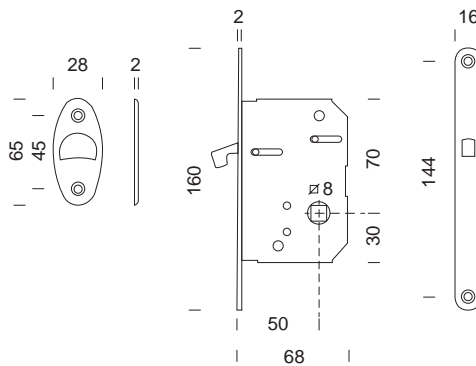

SE108

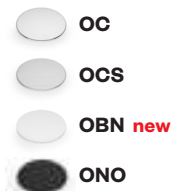

rondò

Ottone
Brass

design:
Dnd technical division

made in italy

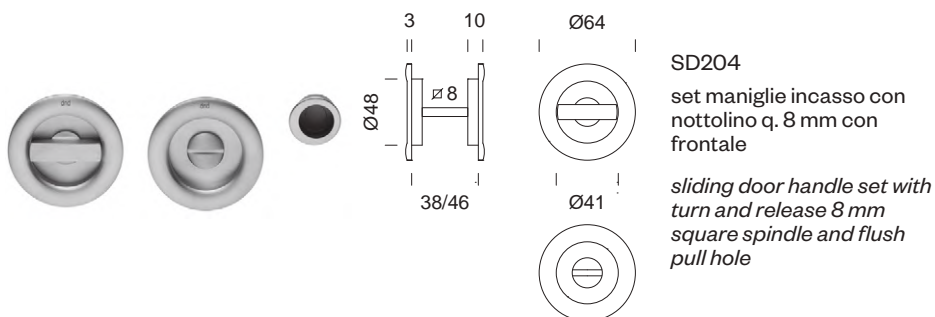
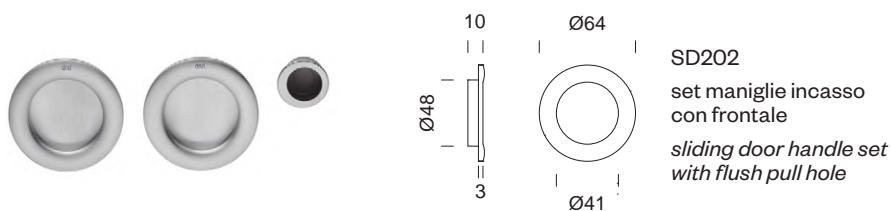
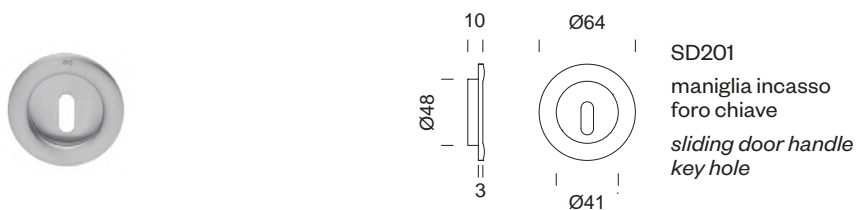
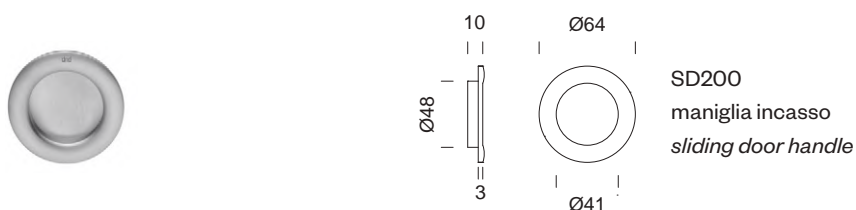
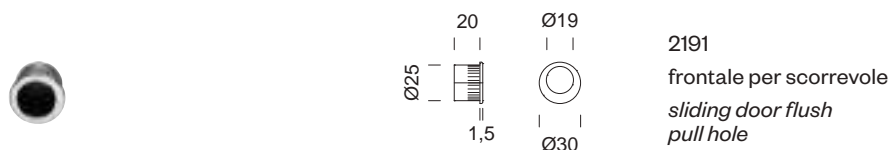

Su richiesta disponibile in tutte le finiture elencate a catalogo
On demand available in all finishes of Dnd catalogue

rondò

Ottone
Brass

design:
Dnd technical division

made in italy





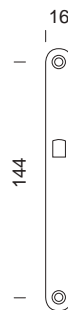
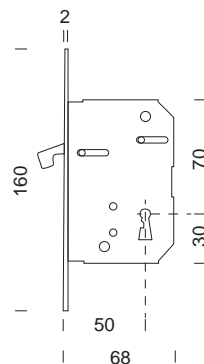
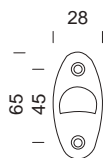

SD205

set maniglie incasso foro chiave con frontale + serratura

sliding door handle set key hole with flush pull hole + lock



SE107

-  **PVD-BG | forte®**
-  **PVD-SG | forte®**
-  **PVD-SCB | forte®**
-  **PVD-SH | forte® new**
-  **PVD-BB | forte® new**
-  **PVD-SB | forte® new**
-  **PVD | forte®**
-  **PGS | forte®**
-  **PVX | forte®**
-  **OLV**
-  **AB**
-  **OGH**
-  **OC**
-  **OCS**
-  **ONS**
-  **OBN**
-  **ONO**



SD206

set maniglie incasso con nottolino q.8 mm con frontale + serratura

sliding door handle set with turn and release 8 mm square spindle with flush pull hole + lock

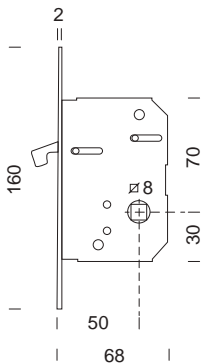
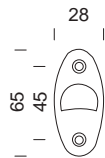
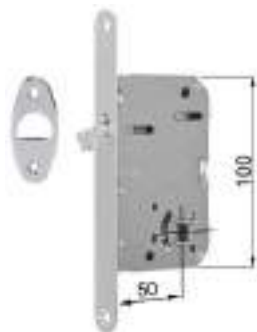

SE108

Su richiesta disponibile in tutte le finiture elencate a catalogo
On demand available in all finishes of Dnd catalogue

ring

Ottone
Brass

design:
Dnd technical division

made in italy

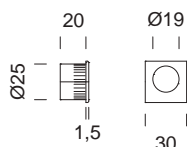

2189
frontale per scorrevole
*sliding door flush
pull hole*

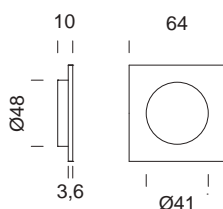

SD220
maniglia incasso
sliding door handle

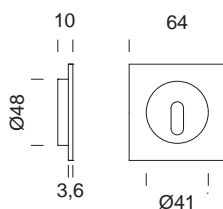

SD221
maniglia incasso
foro chiave
*sliding door handle
key hole*

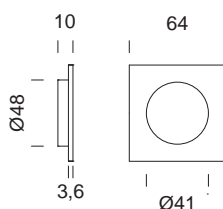

SD222
set maniglie incasso
con frontale
*sliding door handle set
with flush pull hole*

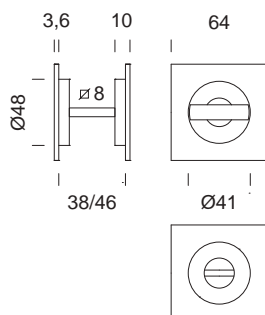

SD224
set maniglie incasso con
nottolino q. 8 mm con
frontale
*sliding door handle set with
turn and release 8 mm
square spindle and flush
pull hole*



Su richiesta disponibile in tutte le finiture elencate a catalogo
On demand available in all finishes of Dnd catalogue

ring

Ottone
Brass

design:
Dnd technical division

made in italy



SD225

set maniglie incasso foro chiave con frontale + serratura

sliding door handle set key hole with flush pull hole + lock

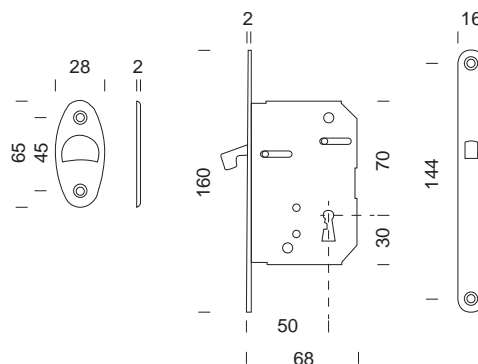
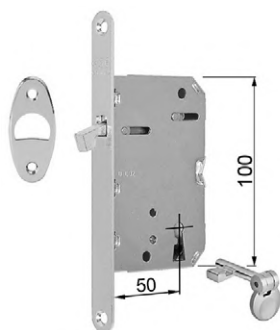

SE107



SD226

set maniglie incasso con nottolino q.8 mm con frontale + serratura

sliding door handle set with turn and release 8 mm square spindle with flush pull hole + lock

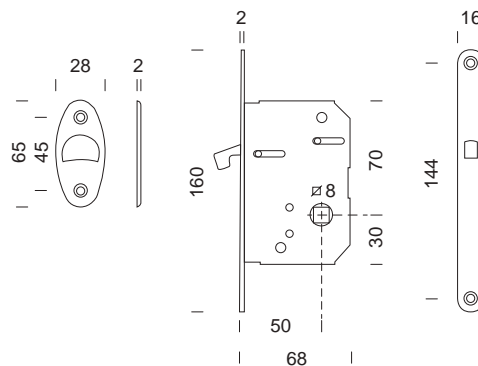
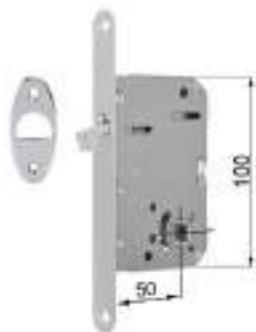

SE108



Su richiesta disponibile in tutte le finiture elencate a catalogo
On demand available in all finishes of Dnd catalogue

tonda

Ottone e zama
Brass and zamak

design:
Dnd technical division

made in italy

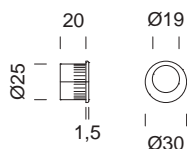

2191
frontale per scorrevole
*sliding door flush
pull hole*

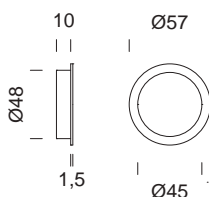

2193
maniglia incasso
sliding door handle

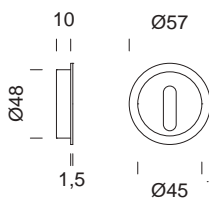

2193/F
maniglia incasso
foro chiave
*sliding door handle
key hole*

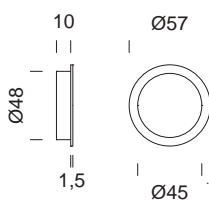

2193/S1
set maniglie incasso
con frontale
*sliding door handle set
with flush pull hole*

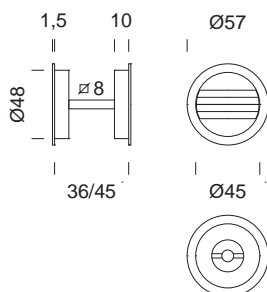
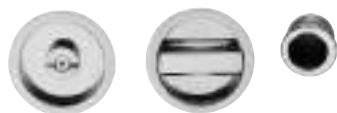

2194/S
set maniglie incasso con
nottolino q. 8 mm con
frontale
*sliding door handle set with
turn and release 8 mm
square spindle and flush
pull hole*

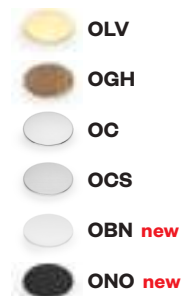

tonda

Ottone e zama
Brass and zamak

design:
Dnd technical division

made in italy



2193/SE107

set maniglie incasso foro chiave
con frontale + serratura

*sliding door handle set key hole with
flush pull hole + lock*



SE107

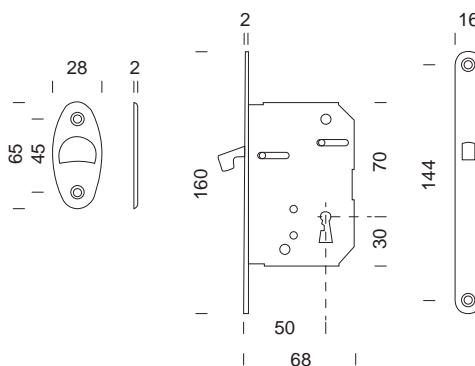

2194/SE108

set maniglie incasso con nottolino q.8 mm con
frontale + serratura

*sliding door handle set with turn and
release 8 mm square spindle with flush pull hole +
lock*



SE108

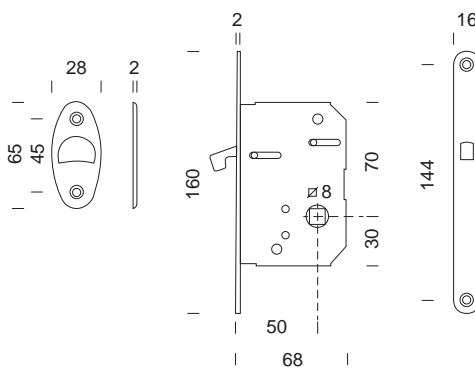

quadra

Ottone e zama
Brass and zamak

design:
Dnd technical division

made in italy

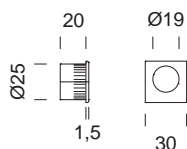

2189
frontale per scorrevole
*sliding door flush
pull hole*

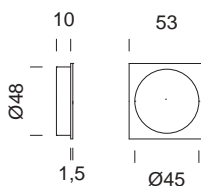

2185
maniglia incasso
sliding door handle

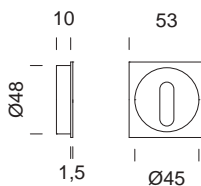

2185/F
maniglia incasso
foro chiave
*sliding door handle
key hole*

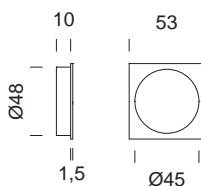
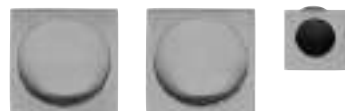

2185/S1
set maniglie incasso
con frontale
*sliding door handle set
with flush pull hole*

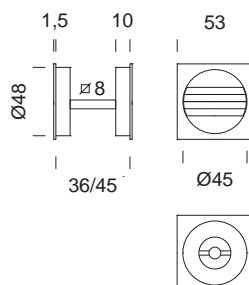

2186/S
set maniglie incasso con
nottolino q. 8 mm con
frontale
*sliding door handle set with
turn and release 8 mm
square spindle and flush
pull hole*

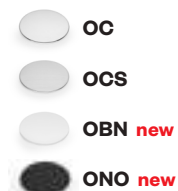

quadra

Ottone e zama
Brass and zamak

design:
Dnd technical division

made in italy



2185/SE107

set maniglie incasso foro chiave
con frontale + serratura

*sliding door handle set key hole with
flush pull hole + lock*

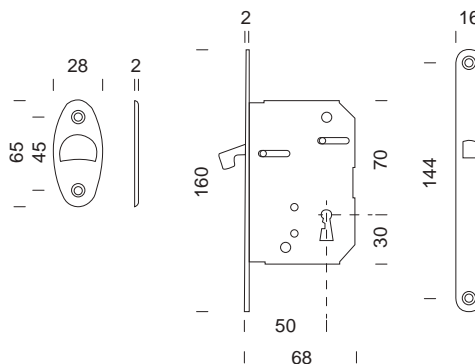

SE107

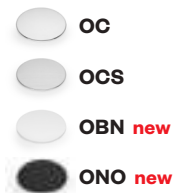

2186/SE108

set maniglie incasso con nottolino q.8 mm con
frontale + serratura

*sliding door handle set with turn and
release 8 mm square spindle with flush pull hole +
lock*

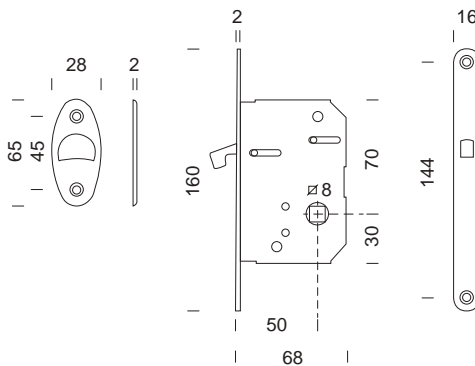
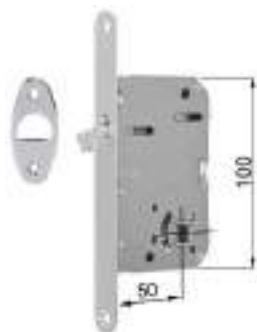

SE108

noxia

design:
Dnd technical division

made in italy

Ottone
Brass

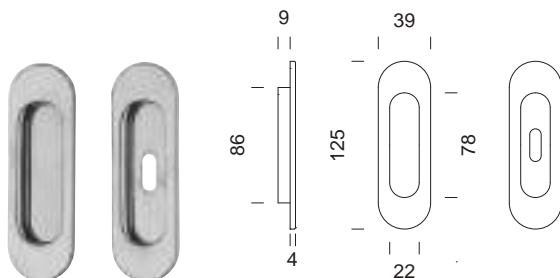

2197
maniglia incasso coprivite
sliding door handle
concealed fixing

2197/F
maniglia incasso coprivite
con foro chiave
sliding door handle key hole
concealed fixing



2197/S1
set maniglie incasso con
frontale
sliding door handle set with
flush pull hole



2197/SE107
set maniglie incasso foro chiave
con frontale + serratura
sliding door handle set key hole
with flush pull hole + lock

SE107



2197/S
set maniglie incasso con nottolino
q. 8 mm e frontale
sliding door handle set with turn and
release 8 mm square spindle and
flush pull hole

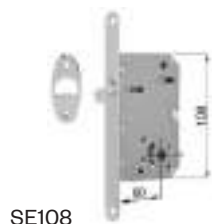

2197/SE108
set maniglie incasso con nottolino
q. 8 mm con frontale e serratura
sliding door handle set with turn and
release 8 mm sq. spindle with flush
pull hole + lock

SE108

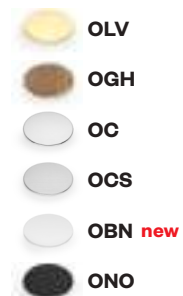

rettangolare

design:
Dnd technical division

made in italy

Ottone
Brass

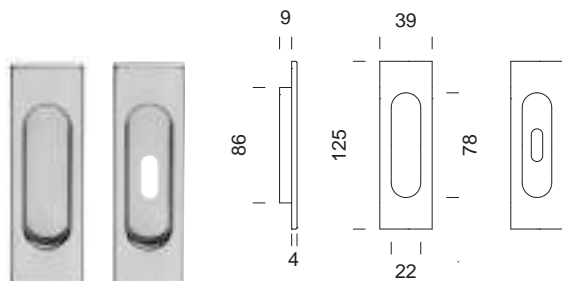

2187
maniglia incasso coprivite
sliding door handle
concealed fixing

2187/F
maniglia incasso coprivite
con foro chiave
sliding door handle key hole
concealed fixing



2187/S1
set maniglie incasso con
frontale
sliding door handle set with
flush pull hole



2187/SE107
set maniglie incasso foro chiave
con frontale + serratura
sliding door handle set key hole
with flush pull hole + lock

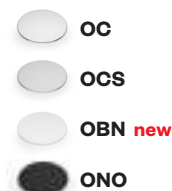

2187/S
set maniglie incasso con nottolino
q. 8 mm e frontale
sliding door handle set with turn and
release 8 mm square spindle and
flush pull hole



2187/SE108
set maniglie incasso con nottolino
q.8 mm con frontale e serratura
sliding door handle set with turn and
release 8 mm sq. spindle with flush
pull hole + lock

articoli

– other

vari

complements

nottolino blend

blend turn & release

Ottone
Brass

design:
Dnd technical division

made in italy

finiture / finishes:

OLV, OS, AB, BSO, OGH, OC, OCS, ONS, NSV,
ONO, OBN, BNL, OVE, TAN, ORA, OBC, OVP, ORO

forte®

PVD-SH, PVD-BB, PVD-SB, PVN, PVD-BG,
PVD-SG, PVD-SCB, PVX, PGS, PVD



2281
nottolino Blend
Blend turn & release

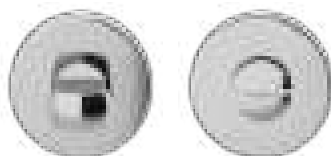

VIS **2403+A**
set nottolino su rosetta
turn & release set on rose
50x7mm - VIS

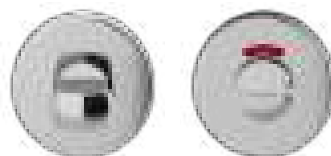

VIS **2403+L new**
set nottolino su rosetta
turn & release set on rose
50x7mm - VIS

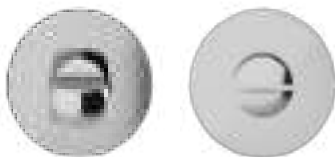

FINE **2406+A**
set nottolino su rosetta
turn & release set on rose
50x4mm - FINE

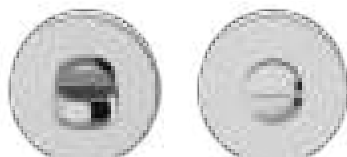

52 **2409+A**
set nottolino su rosetta
turn & release set on rose
52x10mm - 52

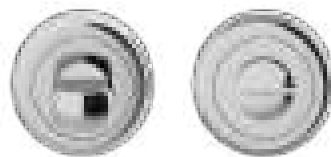

B **2284+A**
set nottolino su rosetta
turn & release set on rose
50mm - B



R **2408+A**
set nottolino su rosetta
turn & release set on rose
53x8mm - LUCREZIA



U **2413+A**
set nottolino Blend su rosetta Unico
Blend turn & release set on Unico rose
30x2mm - UNICO

Consultare il listino prezzi per le finiture disponibili di ogni singolo prodotto
See the price list for the available finishes of each individual product

nottolino blend

blend turn & release

Ottone
Brass

design:
Dnd technical division

made in italy

finiture / finishes:

OLV, OS, AB, BSO, OGH, OC, OCS, ONS, NSV,
ONO, OBN, BNL, OVE, TAN, ORA, OBC, OVP, ORO

forte®

PVD-SH, PVD-BB, PVD-SB, PVN, PVD-BG,
PVD-SG, PVD-SCB, PVX, PGS, PVD



VIS

2405+A
set nottolino su rosetta quadra
turn & release set on square rose
50x7mm - VIS

VIS

2405+L new
set nottolino su rosetta quadra
turn & release set on square rose
50x7mm - VIS

FINE

2407+A
set nottolino su rosetta quadra
turn & release set on square rose
50x4mm - FINE



52

2412+A
set nottolino su rosetta quadra
turn & release set on square rose
52x10mm - 52

Consultare il listino prezzi per le finiture disponibili di ogni singolo prodotto
See the price list for the available finishes of each individual product

nottolino dnd

dnd turn & release

Ottone
Brass

design:
Mauro Ronchi

made in italy

finiture / finishes:

OLV, BSO, OGH, OC, OCS, ONS, NSV, ONO, OBN

forte®

PVD-BB, PVD-SB, PVN, PVD-BG, PVD-SG,
PVD-SCB, PVX, PGS, PVD



NODN1
nottolino Dnd
Dnd turn & release

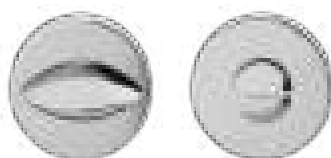

VIS **RDN08+A**
set nottolino su rosetta
turn & release set on rose
50x7mm - VIS

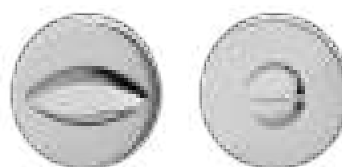

52 **RDN03+A**
set nottolino su rosetta
turn & release set on rose
52x10mm - 52

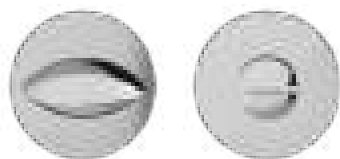

FINE **RDN44+A**
set nottolino su rosetta
turn & release set on rose
50x4mm - FINE



FINE **RDN45+A**
set nottolino su rosetta quadra
turn & release set on square rose
50x4mm - FINE



VIS **RDN09+A**
set nottolino su rosetta quadra
turn & release set on square rose
50x7mm - VIS

Consultare il listino prezzi per le finiture disponibili di ogni singolo prodotto
See the price list for the available finishes of each individual product

nottolino DUE

DUE turn & release

Ottone
Brass

design:
Stefano Boeri Architetti

made in italy

finiture / finishes:

BSO, OGH, OC, OCS, ONO

forte®

PVD-SH, PVD-BB, PVD-SB, PVN, PVD-BG,
PVD-SG, PGS



NODN65
nottolino DUE
DUE turn & release



FINE **RDN68+A**
set nottolino su rosetta
turn & release set on rose
50x4mm - FINE

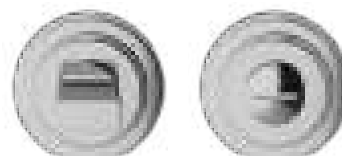

R **RDN80+A**
set nottolino su rosetta
turn & release set on rose
53x8mm - LUCREZIA

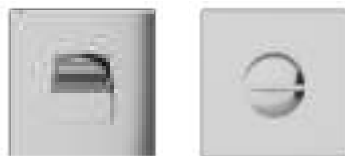

FINE **RDN69+A**
set nottolino su rosetta quadra
turn & release set on square rose
50x4mm - FINE

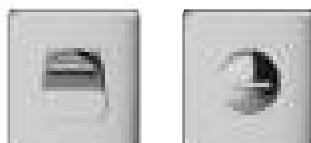

45 **RDN74+A**
set nottolino su rosetta quadra
turn & release set on square rose
45mm

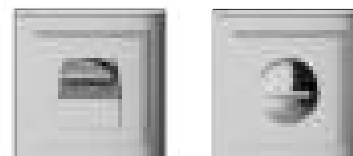

R **RDN81+A**
set nottolino su rosetta quadra
turn & release set on square rose
53x8mm - LUCREZIA

Consultare il listino prezzi per le finiture disponibili di ogni singolo prodotto
See the price list for the available finishes of each individual product

nottolino (IN)finito (IN)finito turn & release

Ottone
Brass

design:
Alfonso Femia

made in italy

finiture / finishes:
OLV, SO, AB, OC, OCS, ONO
forte®
PVD-BB, PVD-SB, PGS



NODN66
nottolino (IN)finito
(IN)finito turn & release

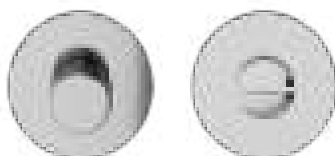

FINE **RDN75+A**
set nottolino su rosetta
turn & release set on rose
50x4mm - FINE

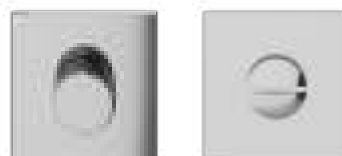

FINE **RDN76+A**
set nottolino su rosetta quadra
turn & release set on square rose
50x4mm - FINE

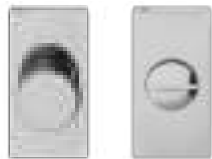

R **RDN66+A**
set nottolino su rosetta
minimale (IN)finito
turn & release set on minimal
(IN)finito rose
25x50mm - (IN)finito

Consultare il listino prezzi per le finiture disponibili di ogni singolo prodotto
See the price list for the available finishes of each individual product

nottolino joy

joy turn & release

Zama
Zamak

design:
Dnd technical division

made in italy

finiture / finishes:
ZC, ZCS, ZOS, ZGH, ZAN, ZBN, ZNE, ZRO, ZBR,
ZNS, ZOR



JYDN10
nottolino Joy
Joy turn & release



VIS **RDN22+A**
set nottolino su rosetta
turn & release set on rose
50x7mm - VIS

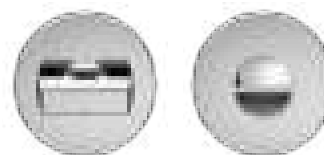

FINE **RDN47+A**
set nottolino su rosetta
turn & release set on rose
50x4mm - FINE



S **2305+A**
set nottolino su rosetta stretta
RO16
turn & release set on RO16
narrow rose
30x60mm

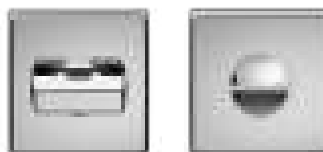

VIS **RDN24+A**
set nottolino su rosetta quadra
turn & release set on square rose
50x7mm - VIS

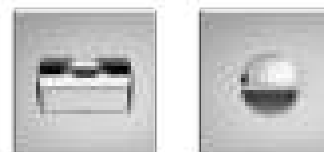

FINE **RDN48+A**
set nottolino su rosetta quadra
turn & release set on square
rose
50x4mm - FINE



45 **RDN49+A new**
set nottolino su rosetta Pluris
turn & release set on Pluris rose
45x45mm



S **2303+A**
set nottolino su rosetta stretta RO23
turn & release set on RO23 narrow rose
30x60mm

Consultare il listino prezzi per le finiture disponibili di ogni singolo prodotto
See the price list for the available finishes of each individual product

nottolino logo logo turn & release

Ottone
Brass

design:
Mauro Ronchi

made in italy

finiture / finishes:
OGH, AB, OC, OCS, ONS, OBN, ONO, INOX
forte®
PVD-BG, PVD-SG, PVD-SCB, PGS, PVX



NODN10
nottolino Logo
Logo turn & release

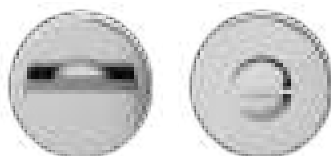

VIS **RDN12+A / RDN12X+A (Inox)**
set nottolino su rosetta
turn & release set on rose
50x7mm - VIS

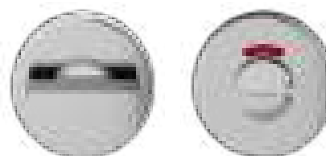

VIS **RDN12+L new**
set nottolino su rosetta
turn & release set on rose
50x7mm - VIS

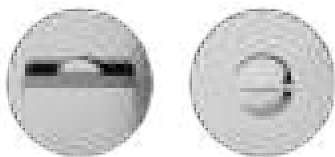

FINE **RDN40+A**
set nottolino su rosetta
turn & release set on rose
50x4mm - FINE

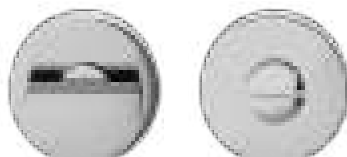

52 **RDN13+A**
set nottolino su rosetta
turn & release set on rose
52x10mm - 52

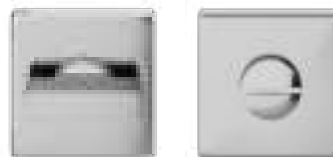

VIS **RDN14+A**
set nottolino su rosetta quadra
turn & release set on square rose
50x7mm - VIS

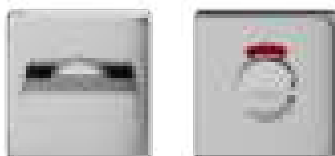

VIS **RDN14+L new**
set nottolino su rosetta quadra
turn & release set on square rose
50x7mm - VIS

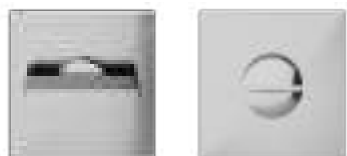

FINE **RDN41+A**
set nottolino su rosetta quadra
turn & release set on square rose
50x4mm - FINE



52 **RDN15+A**
set nottolino su rosetta quadra
turn & release set on square rose
52x10mm - 52

Consultare il listino prezzi per le finiture disponibili di ogni singolo prodotto
See the price list for the available finishes of each individual product

nottolino lucrezia

lucrezia turn & release

Ottone
Brass

design:
Marco Pisati

made in italy

finiture / finishes:

OGH, OC, OCS

forte®

PVN, PVD-BG, PVD-SG, PGS

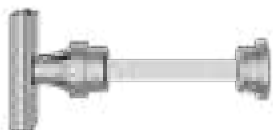

NODN30

nottolino Lucrezia
Lucrezia turn & release

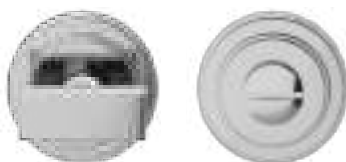

R

RDN30+A

set nottolino su rosetta
turn & release set on rose
53x8mm - LUCREZIA

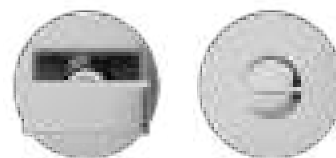

FINE

RDN31+A

set nottolino su rosetta
turn & release set on rose
50x4mm - FINE



R

RDN33+A

set nottolino su rosetta quadra
turn & release set on square rose
53x8mm - LUCREZIA

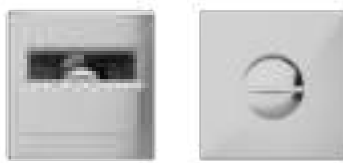

FINE

RDN32+A

set nottolino su rosetta quadra
turn & release set on square rose
50x4mm - FINE

Consultare il listino prezzi per le finiture disponibili di ogni singolo prodotto
See the price list for the available finishes of each individual product

nottolino pod *pod turn & release*

Ottone
Brass

design:
Holscher Design

made in italy

finiture / finishes:
OC, OCS, ONO

forte®
PVD-BB, PVD-SB, PVD-BG, PVD-SG, PGS



NODN77
nottolino Pod
Pod turn & release

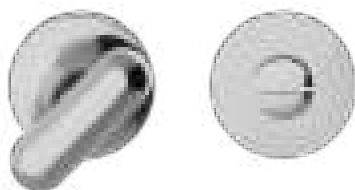

FINE **RDN77+A**
set nottolino Pod su rosetta
Pod turn & release set on rose
50x4mm - FINE

nottolino timeless *timeless turn & release*

Alluminio
Aluminium

design:
Marco Pisati

made in italy

finiture / finishes:
ASV, ARO, ABR, ABN, ANE, ABT, AGO, AVP,
ABC



NODN50
nottolino Timeless
Timeless turn & release

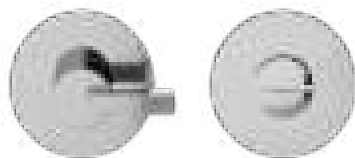

FINE **RDN50+A**
set nottolino su rosetta
turn & release set on rose
50x4mm - FINE

Consultare il listino prezzi per le finiture disponibili di ogni singolo prodotto
See the price list for the available finishes of each individual product

nottolino short short turn & release

Ottone
Brass

design:
Dnd technical division

made in italy

finiture / finishes:

OLV, OS, AB, OC, OCS, NSV, ONS, OBN, ONO,
ORA, OBC, OVP

forte®

PVD-SH, PVD-BB, PVD-SB, PVN, PVD-BG,
PVD-SG, PVD-SCB, PGS, PVX, PVD



NODN20
nottolino Short
Short turn & release



VIS **RDN25+A**
set nottolino su rosetta
turn & release set on rose
50x7mm - VIS



52 **RDN27+A**
set nottolino su rosetta
turn & release set on rose
52x10mm - 52



FINE **RDN20+A**
set nottolino su rosetta
turn & release set on rose
50x4mm - FINE



VIS **RDN26+A**
set nottolino su rosetta quadra
turn & release set on square rose
50x7mm - VIS



52 **RDN28+A**
set nottolino su rosetta quadra
turn & release set on square rose
52x10mm - 52



FINE **RDN21+A**
set nottolino su rosetta quadra
turn & release set on square rose
50x4mm - FINE



NODN89 new
nottolino Short ADA
Short ADA turn & release

VIS **RDN92+A new**
set nottolino Short ADA su rosetta
Short ADA turn & release set on rose
50x7mm - VIS

Consultare il listino prezzi per le finiture disponibili di ogni singolo prodotto
See the price list for the available finishes of each individual product

nottolino tedesco *tedesco turn & release*

Ottone
Brass

design:
Dnd technical division

made in italy

finiture / finishes:
OLV, OS, AB, AF, OGC, OGH, OC, OCS, ONV,
ONS, FAN, BSS, ORO

forte®
PVD-BG, PVD-SG



2279
nottolino Tedesco
Tedesco turn & release



VIS **2402+A**
set nottolino su rosetta
turn & release set on rose
50x7mm - VIS



FINE **2291+A**
set nottolino su rosetta
turn & release set on rose
50x4mm - FINE



B **2286+A**
set nottolino su rosetta
turn & release set on rose
50mm - B



52 **2452+A**
set nottolino su rosetta
turn & release set on rose
52x10mm - 52



R **2315+A**
set nottolino su rosetta
turn & release set on rose
55mm - FIORENZA



R **2300+A**
set nottolino su rosetta
turn & release set on rose
52x63mm - LATINA

Consultare il listino prezzi per le finiture disponibili di ogni singolo prodotto
See the price list for the available finishes of each individual product

nottolini su rosette strette

turn & releases on narrow roses

Ottone
Brass

design:
Dnd technical division

made in italy

finiture / finishes:

OLV, OS, AB, OGC, OGH, OC, OCS, ONV, ONS, OBN, ONO

forte®

PVD-SH, PVD-BB, PVD-SB, PVN, PGS, PVX, PVD

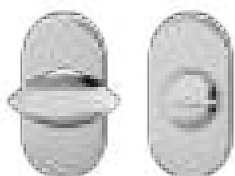

S **RDN60+A**
set nottolino Dnd su rosetta stretta RO16
Dnd turn & release set on RO16 narrow rose
30x60mm

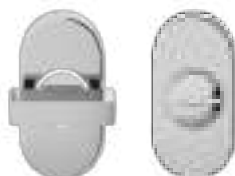

S **RDN62+A**
set nottolino Logo su rosetta stretta RO16
Logo turn & release set on RO16 narrow rose
30x60mm

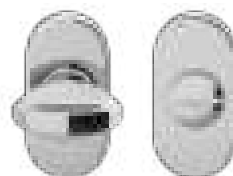

S **2290+A**
set nottolino Tedesco su rosetta stretta RO16
Tedesco turn & release set on RO16 narrow rose
30x60mm

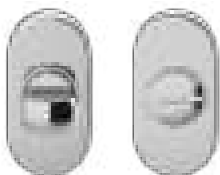

S **2301+A**
set nottolino Blend su rosetta stretta RO16
Blend turn & release set on RO16 narrow rose
30x60mm

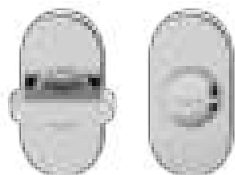

S **RDN34+A**
set nottolino Short su rosetta stretta
Short turn & release set on narrow rose
30x60mm

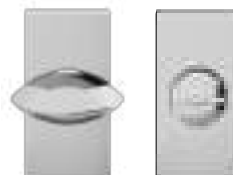

S **RDN61+A**
set nottolino Dnd su rosetta stretta Dnd
Dnd turn & release set on Dnd narrow rose
30x60mm

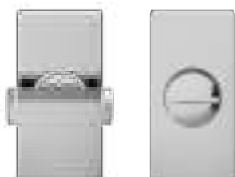

S **RDN63+A**
set nottolino Logo su rosetta stretta Dnd
Logo turn & release set on RO16 narrow Dnd rose
30x60mm

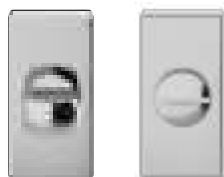

S **2304+A**
set nottolino Blend su rosetta stretta RO23
Blend turn & release set on RO23 narrow rose
30x60mm

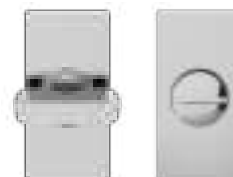

S **RDN35+A**
set nottolino Short su rosetta stretta
Short turn & release set on narrow rose
30x60mm

Consultare il listino prezzi per le finiture disponibili di ogni singolo prodotto
See the price list for the available finishes of each individual product

bocchette tonde *round escutcheons*

Ottone
Brass

design:
Dnd technical division

made in italy

finiture / finishes:

OLV, OS, AB, AF, OGC, OGH, OC, OCS, ONV,
ONS, FAN, OBN, ONO, ORO, INOX LUC., INOX SAT.

forte®

PVD-SH, PVD-BB, PVD-SB, PVN, PVD-BG,
PVD-SG, PVD-SCB, PGS, PVX, PVD

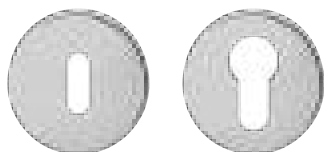

VIS **BD12P / BD12Y**
bocchetta
escutcheon
50x7mm - VIS

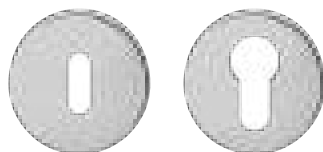

VIS **BD12XP / BD12XY (Inox)**
bocchetta
escutcheon
50x7mm - VIS

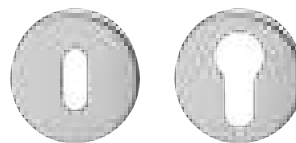

45 **BD01P / BD01Y**
bocchetta
escutcheon
45mm

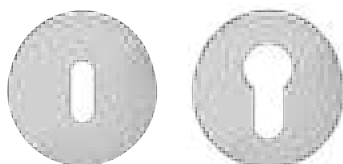

52 **BD03P / BD03Y**
bocchetta
escutcheon
52x10mm - 52

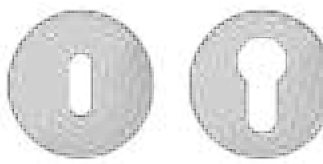

FINE **BD40P / BD40Y**
bocchetta 4mm
escutcheon 4mm
50x4mm - FINE

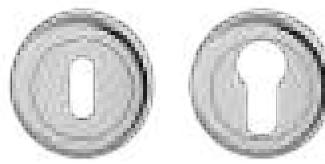

B **BO20P / BO20Y**
bocchetta bombata
rounded escutcheon
50mm - B



VIS **BD35**
bocchetta cieca
blind escutcheon
50x7mm - VIS



VIS **BD36**
bocchetta doppia mappa
escutcheon special key hole
50x7mm - VIS

Consultare il listino prezzi per le finiture disponibili di ogni singolo prodotto
See the price list for the available finishes of each individual product

bocchette quadre square escutcheons

Ottone
Brass

design:
Dnd technical division

made in italy

finiture / finishes:

OLV, OS, AB, AF, OGC, OGH, OC, OCS, ONV,
ONS, FAN, OBN, ONO, ORO

forte®

PVD-SH, PVD-BB, PVD-SB, PVN, PVD-BG,
PVD-SG, PVD-SCB, PGS, PVX, PVD



VIS

BD14P / BD14Y
bocchetta quadra
square escutcheon
50x7mm - VIS



45

BD06P / BD06Y
bocchetta quadra
square escutcheon
45mm



52

BD04P / BD04Y
bocchetta quadra
square escutcheon
52x10mm - 52



FINE

BD41P / BD41Y
bocchetta quadra 4mm
square escutcheon 4mm
50x4mm - FINE



VIS

BD37
bocchetta quadra cieca
blind square escutcheon
50x7mm - VIS



VIS

BD38
bocchetta quadra doppia mappa
square escutcheon special key hole
50x7mm - VIS

Consultare il listino prezzi per le finiture disponibili di ogni singolo prodotto
See the price list for the available finishes of each individual product

bocchette speciali *special escutcheons*

Ottone
Brass

design:
Dnd technical division

made in italy

finiture / finishes:

OLV, OS, SO, AB, AF, OGC, OGH, OC, OCS, ONV,
ONS, FAN, BSS, OBN, ONO, ORO

forte®

PVD-SH, PVD-BB, PVD-SB, PVN, PVD-BG,
PVD-SG, PVD-SCB, PGS, PVX, PVD

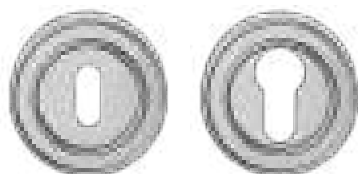

R **BF10P / BF10Y**
bocchetta Fiorenza
Fiorenza escutcheon
55mm - R



R **BD32P / BD32Y**
bocchetta Lucrezia
Lucrezia escutcheon
53x8mm - R

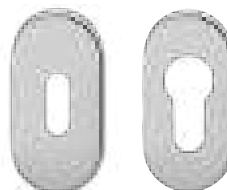

S **BO16P / BO16Y**
bocchetta
escutcheon
30x60mm

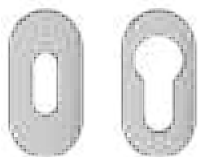

U **BD80P / BD80Y**
bocchetta UNICO
UNICO escutcheon
25x50mm



R **BD33P / BD33Y**
bocchetta Lucrezia
Lucrezia escutcheon
53x8mm - R

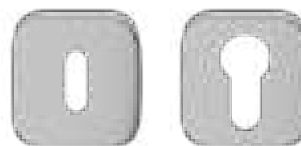

45 **BD48P / BD48Y** **new**
bocchetta Pluris
Pluris escutcheon
45x45mm

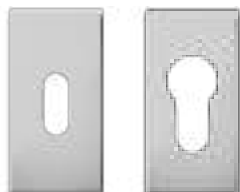

S **BD61P / BD61Y**
bocchetta rettangolare Dnd
Dnd rectangular escutcheon
30x60mm

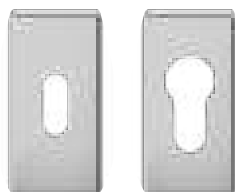

S **BO23P / BO23Y**
bocchetta
escutcheon
30x60mm



R **BO42P / BO42Y**
bocchetta Latina
Latina escutcheon
52x63mm - R

Consultare il listino prezzi per le finiture disponibili di ogni singolo prodotto
See the price list for the available finishes of each individual product

fermaporta door stop

Ottone
Brass



2268/1
fermaporta classic a
parete
classic on wall door stop
35x87mm

OLV
OGH
OC
OCS
ORO



2268
fermaporta classic a
pavimento
classic on floor door stop
42x96mm

design:
Dnd technical division

made in italy



2264
fermaporta chiocciola
door stop
45mm

OLV
OGH
OC
OCS
ONS
ONO



R1200
fermaporta ring
ring door stop
30x30mm

OLV
OGH
OC
OCS
ONS
ONO

forte®

PVD-SH
PVD-BB
PVD-SB
PVD
PVD-BG
PVD-SG
PVD-SCB
PVN
PGS
PVX



2265 leggero/light
2265/P pesante/heavy
fermaporta cilindro
door stop
29x45mm

OLV
OGH
OC
OCS
ONS
ONO

chiavi keys

Ottone
Brass



DO1C
chiave dolce
dolce key



VI1C
chiave vita
vita key

finiture / finishes:

OLV, OS, AB, OC, OCS, ONS, OBN, ONO

forte®

PVD-SH, PVD-BB, PVD-SB, PVN, PVD-BG, PVD-SG,
PVD-SCB, PGS

cerniere - copricerniere hinges - cover hinges

design:
Dnd technical division

made in italy

Ottone
Brass

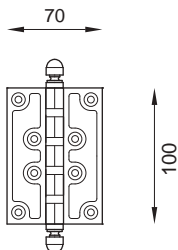

2307
cerniera classic
classic hinge

OLV	AB	FAN
OS	OGC	
AF	OGH	

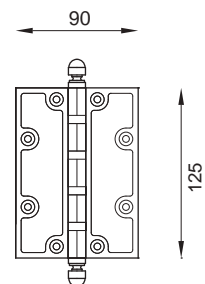

2307/1
cerniera classic
classic hinge

OLV	AB	FAN
OS	OGC	
AF	OGH	

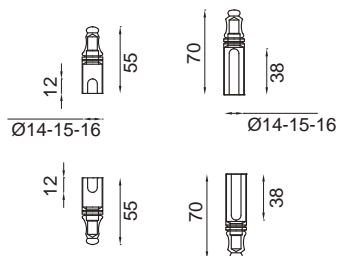

2313
set copricerniere corto con piramide
short cover hinges set with pyramid

2313/2
set copricerniere lungo con piramide asole lunghe
long cover hinges set with pyramid long holes

OLV	AB	FAN
OS	OGC	
AF	OGH	

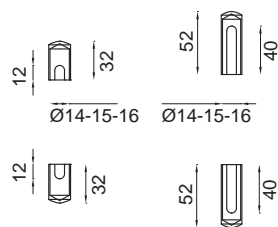

2314
set copricerniere corto piatto
flat short cover hinges set

2314/2
set copricerniere lungo con asole lunghe e corte
cover hinges set with long or short holes

OLV	ONS
OC	
OCS	

placche plates

Ottone
Brass



PL829 latina
57x265mm



PL570 classic
46x252mm



PL310 noxia
40x251mm



PL169 quadra
42x245mm



PL520 fiorenza
65x320mm



PL550 lucrezia
53x300mm



PLD01 dnd
245mm



PL279 sabina
38x236mm



PL390 daniela
40x247mm



PL400 slide
35x160mm



PL283 sabina
35x175mm



PL394 daniela
37x170mm



PL401 slide quadra
35x160mm

disegni

– technical

tecnici

drawings

airone

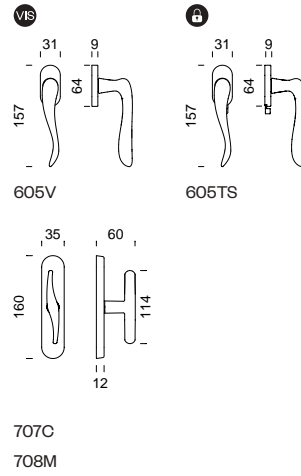
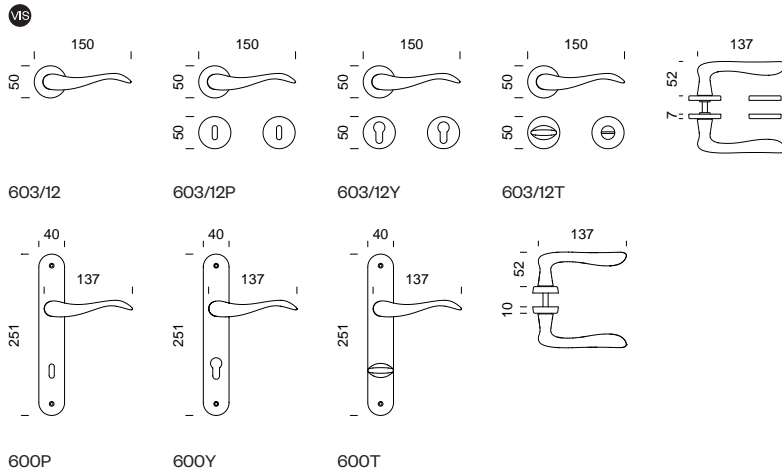

anik

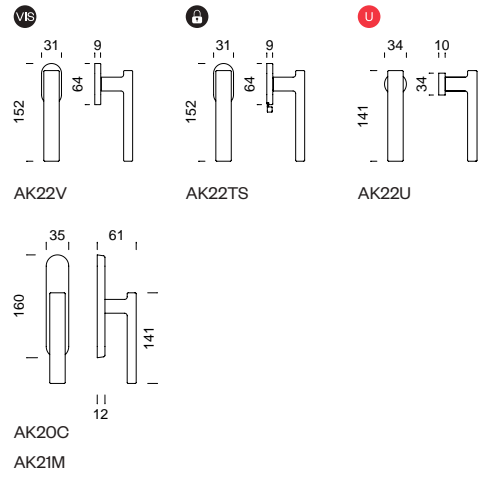
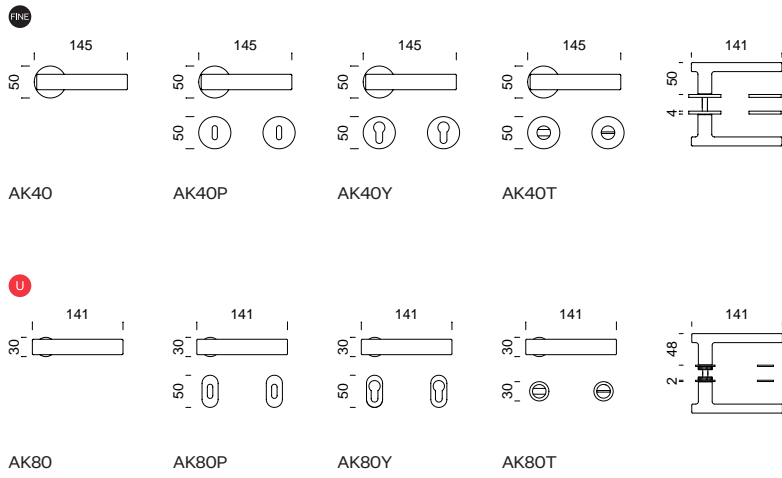

anik 02

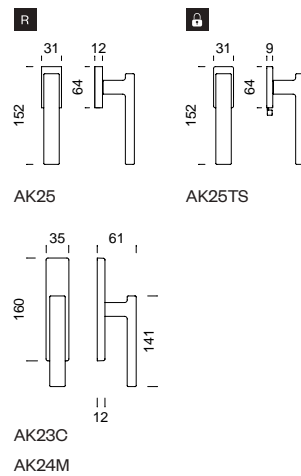
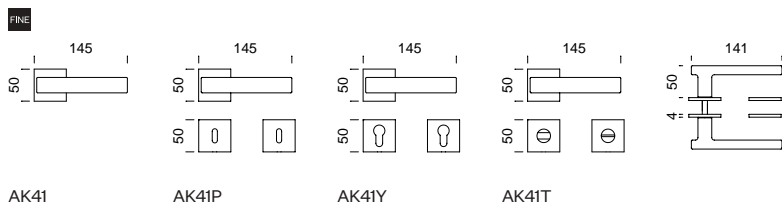

anik brilliant NEW

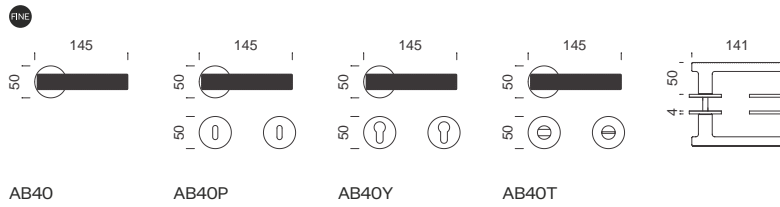

AB40 AB40P AB40Y AB40T

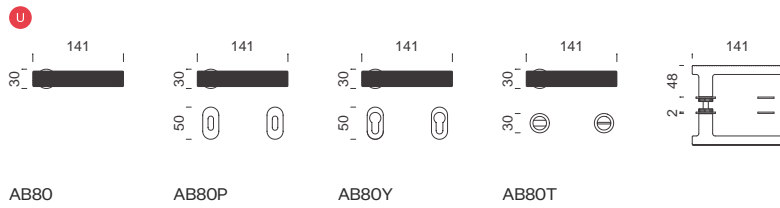

AB80 AB80P AB80Y AB80T

anik brilliant 02 NEW

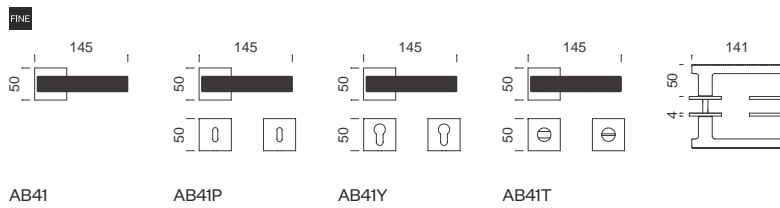

AB41 AB41P AB41Y AB41T

anik line NEW

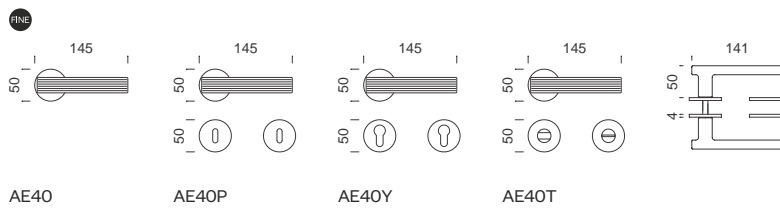

AE40 AE40P AE40Y AE40T

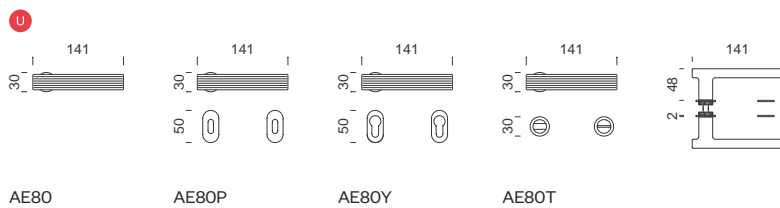

AE80 AE80P AE80Y AE80T

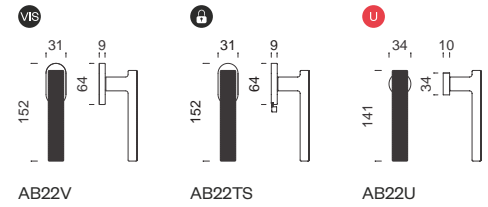

AB22V AB22TS AB22U

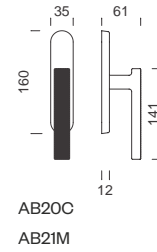

AB20C
AB21M

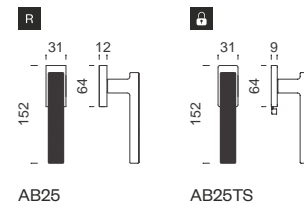

AB25 AB25TS

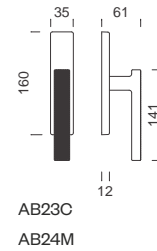

AB23C
AB24M

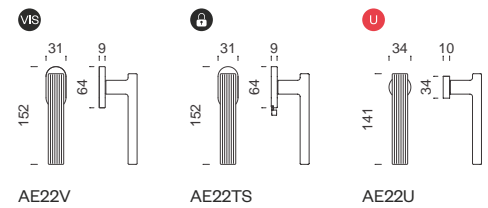

AE22V AE22TS AE22U

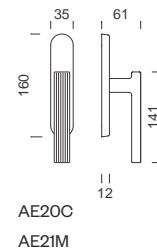

AE20C
AE21M

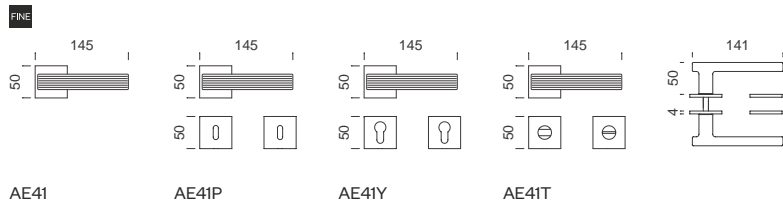

AE41 AE41P AE41Y AE41T

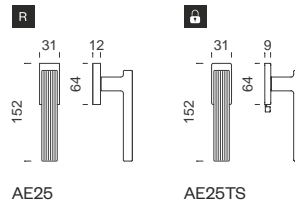

AE25 AE25TS

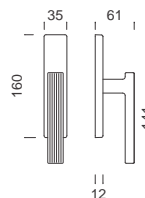

AE23C
AE24M

appia

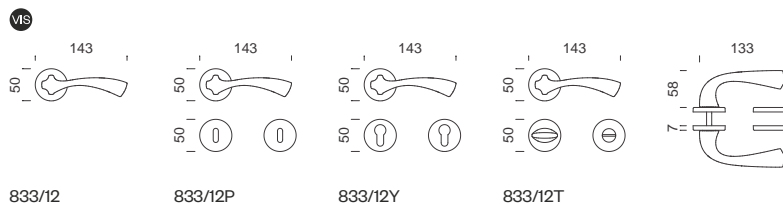

833/12 833/12P 833/12Y 833/12T

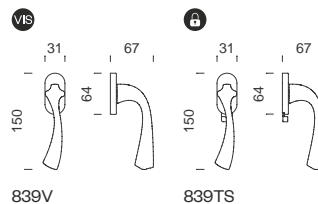

839V 839TS

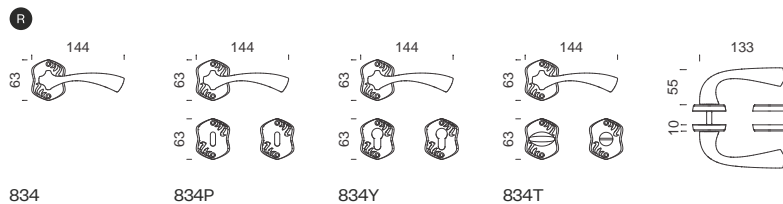

834 834P 834Y 834T

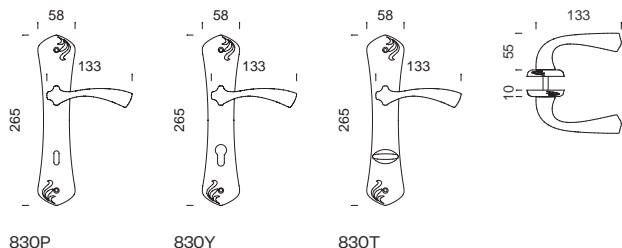

830P 830Y 830T

aretè

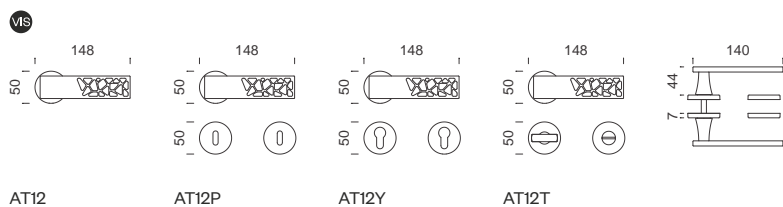

AT12 AT12P AT12Y AT12T

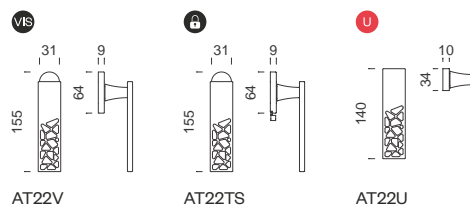

AT22V AT22TS AT22U

aretè

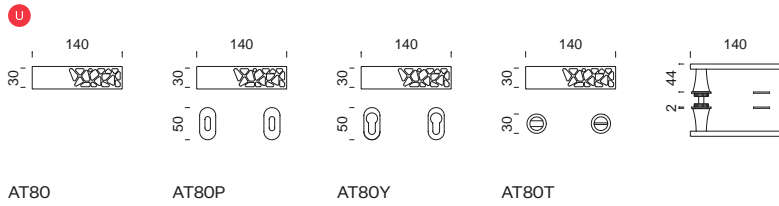
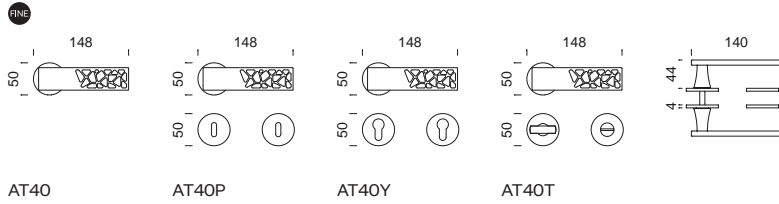

aretè 02

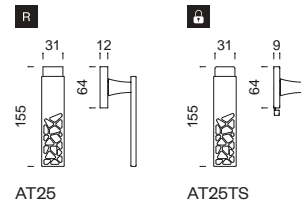
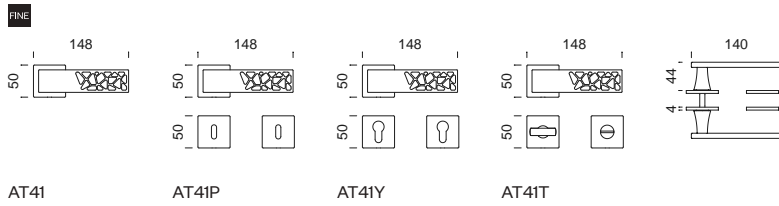
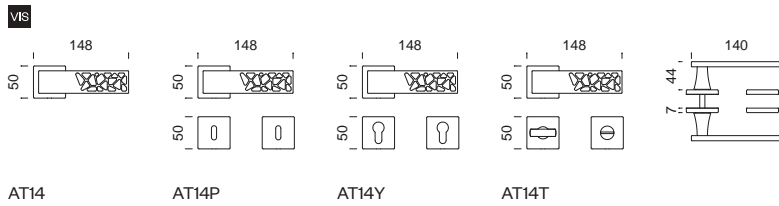

aretè L

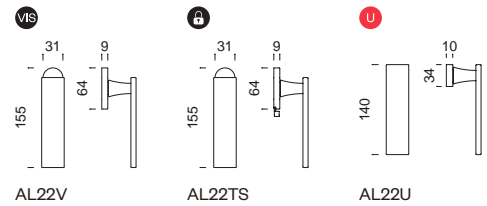
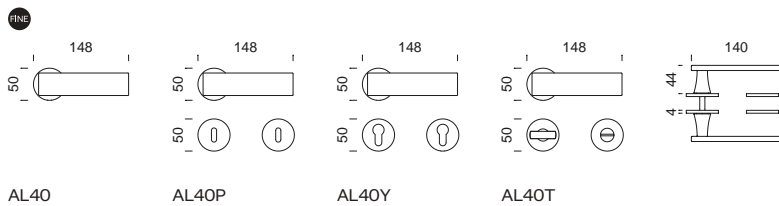
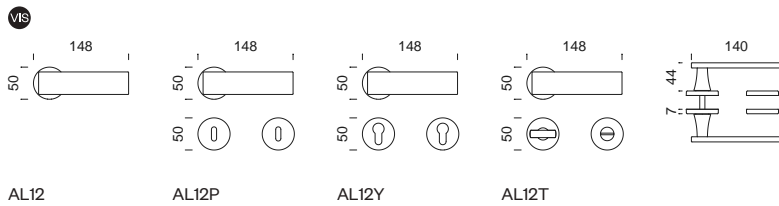

aretè L

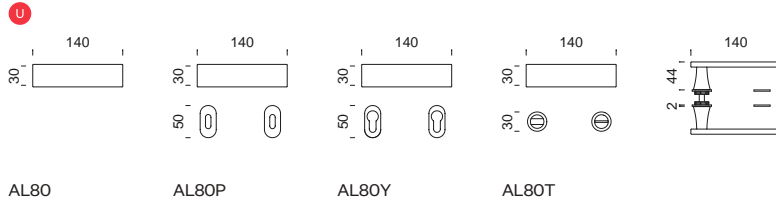

aretè L 02

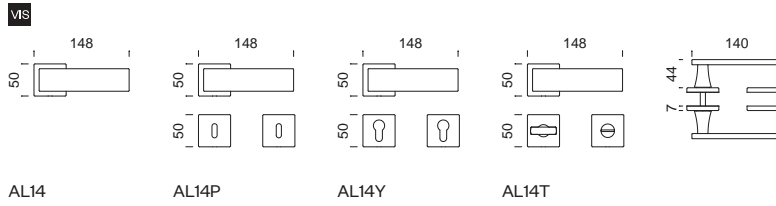

AL14

AL14P

AL14Y

AL14T

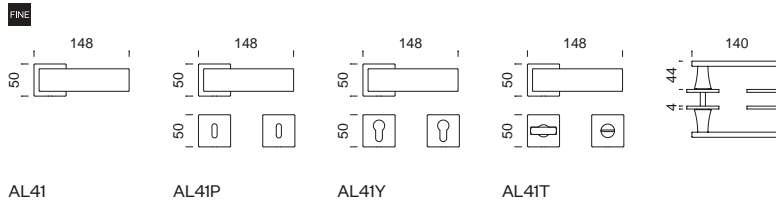

AL41

AL41P

AL41Y

AL41T

art

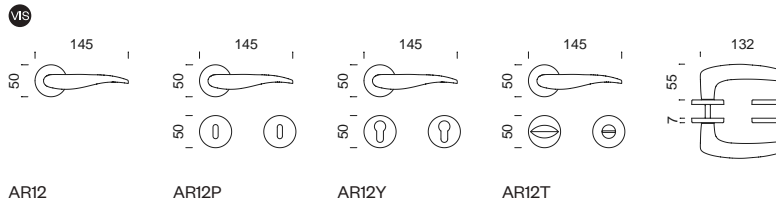

AR12

AR12P

AR12Y

AR12T

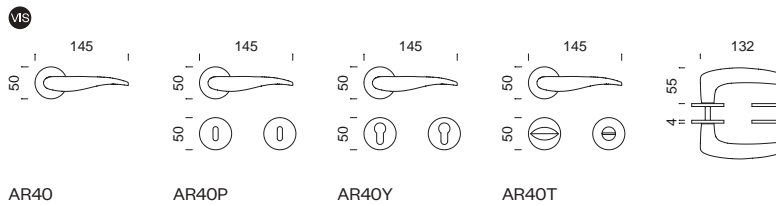

AR40

AR40P

AR40Y

AR40T

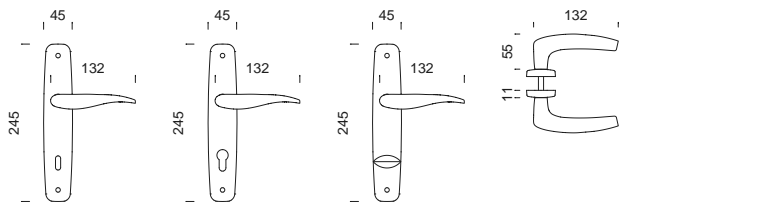

AR10P

AR10Y

AR10T

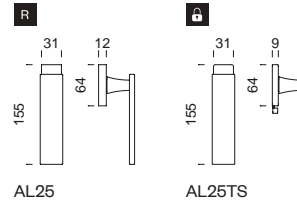

AL25

AL25TS

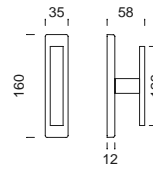

ED26C

ED26M

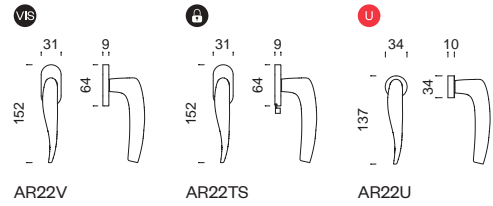

AR22V

AR22TS

AR22U

art

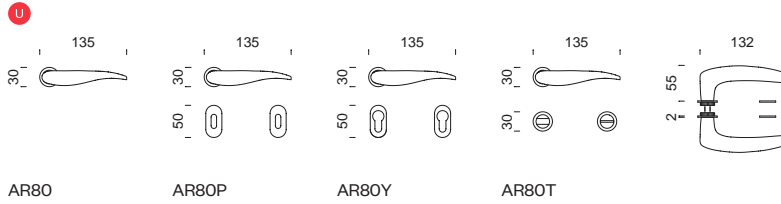

AR80 AR80P AR80Y AR80T

artik

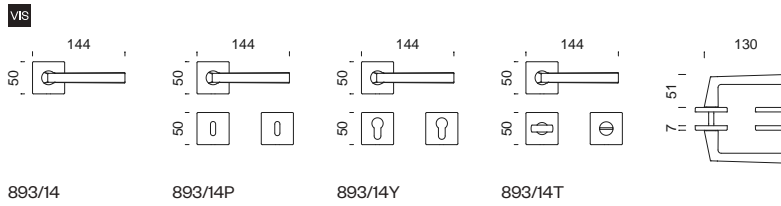

893/14 893/14P 893/14Y 893/14T

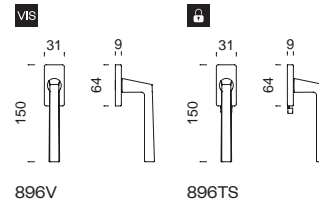

896V 896TS

beauty

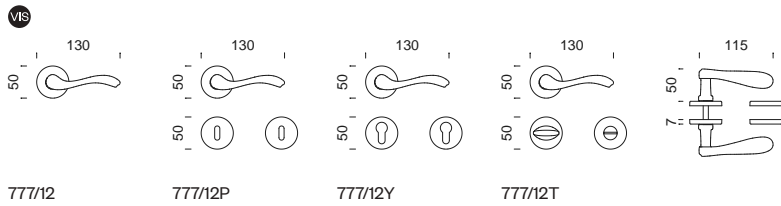

777/12 777/12P 777/12Y 777/12T

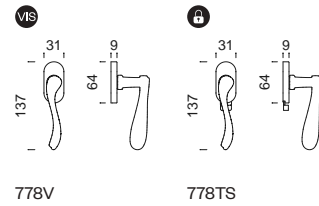

778V 778TS

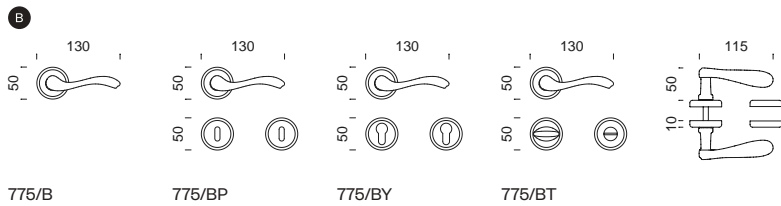

775/B 775/BP 775/BY 775/BT

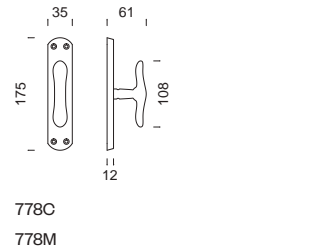

778C 778M

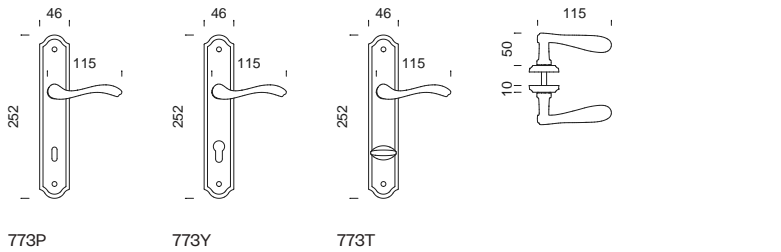

773P 773Y 773T

blend

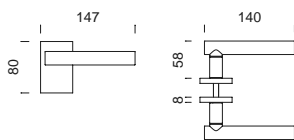

BN10/R

blend

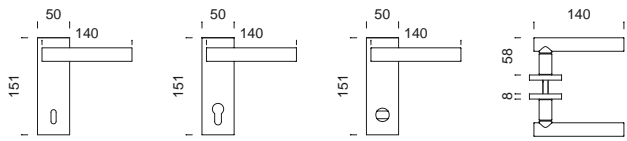

BN10P

BN10Y

BN10T

U

BN22U

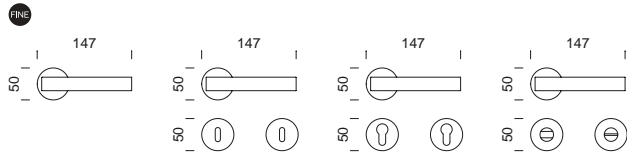

BN40

BN40P

BN40Y

BN40T

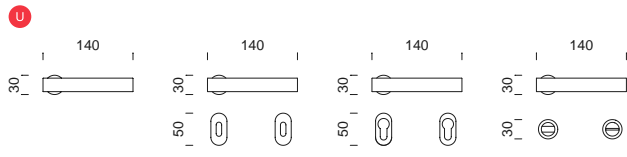

BN80

BN80P

BN80Y

BN80T

blend O2

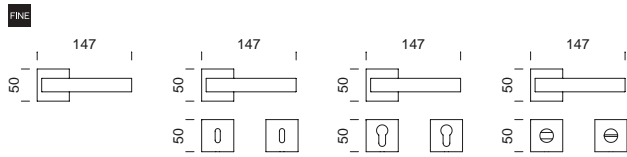

BN41

BN41P

BN41Y

BN41T

R

BN25

B

BN25TS

blip

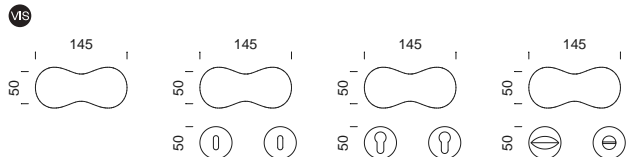

BL12

BL12P

BL12Y

BL12T

boole

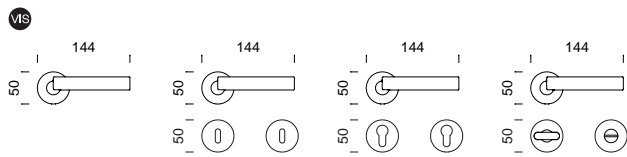

BE12

BE12P

BE12Y

BE12T

vis

BE22V

B

BE22TS

boole

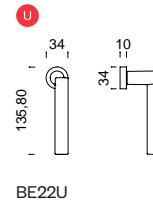
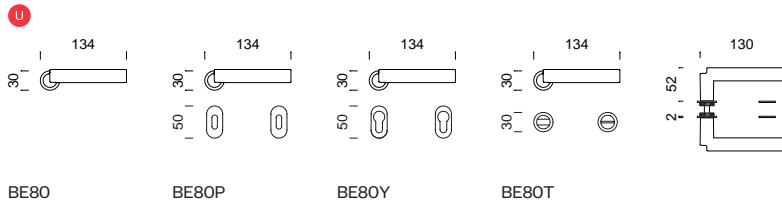
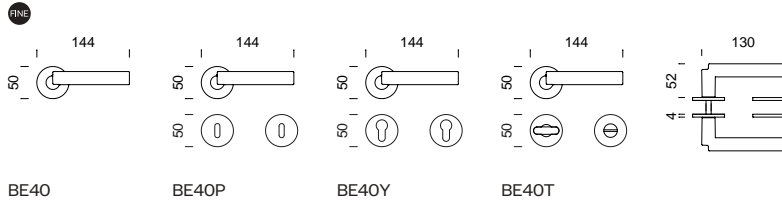

bruxelles

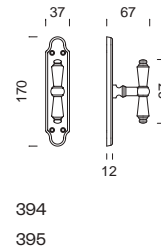
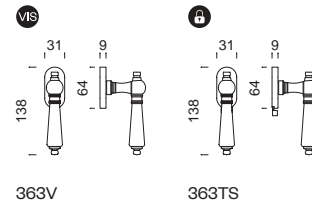
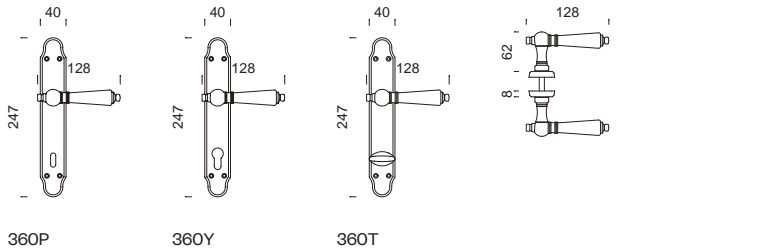
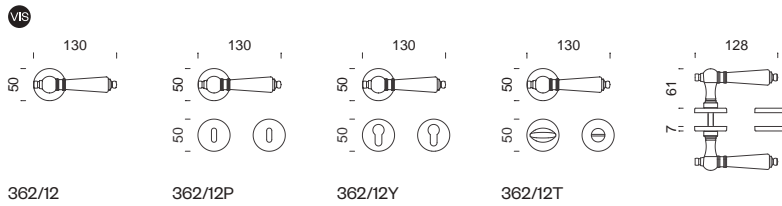

C-1918

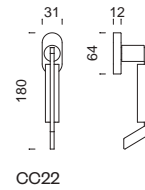
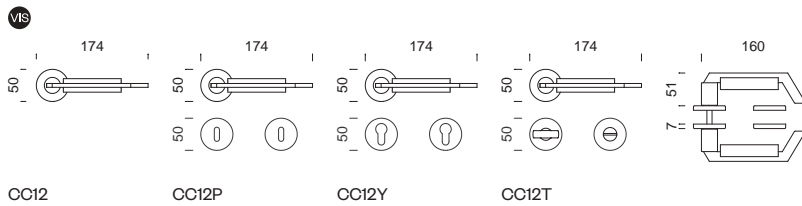

change B 02

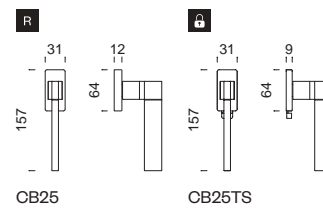
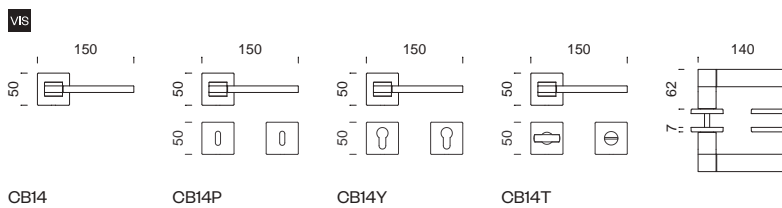

chop

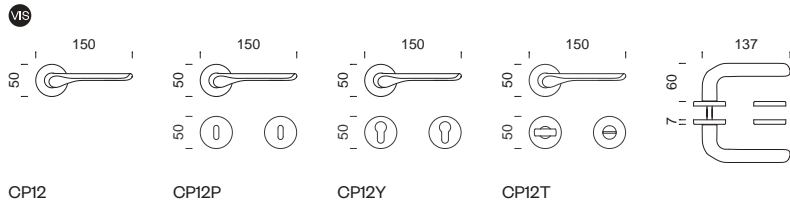

CP12

CP12P

CP12Y

CP12T

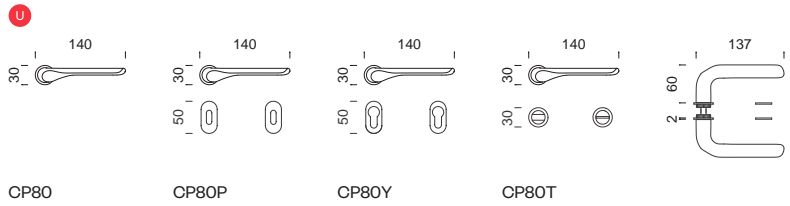

CP80

CP80P

CP80Y

CP80T

classic

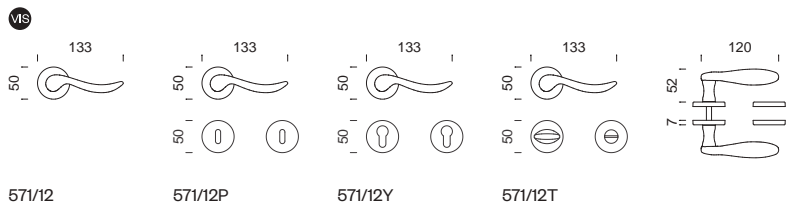

571/12

571/12P

571/12Y

571/12T

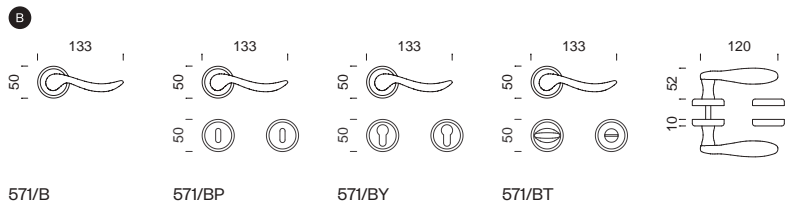

571/B

571/BP

571/BY

571/BT

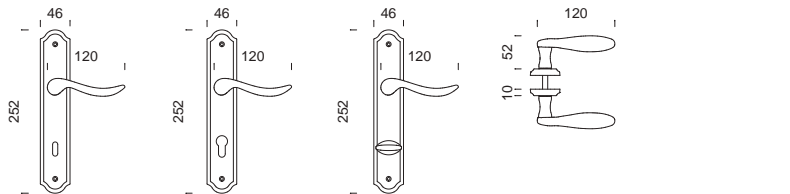

570P

570Y

570T

cloe

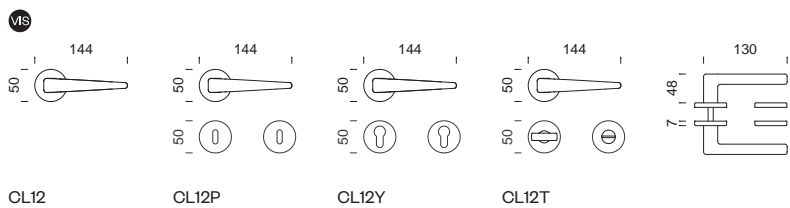

CL12

CL12P

CL12Y

CL12T

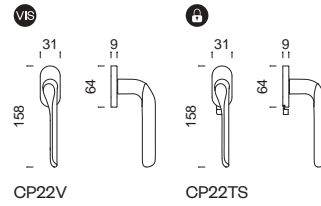

CP22V

CP22TS

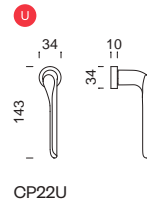

CP22U

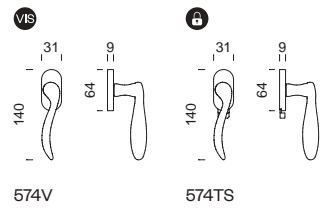

574V

574TS

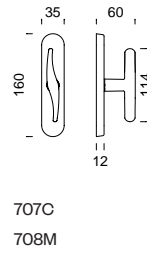

707C

708M

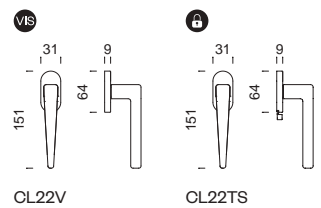

CL22V

CL22TS

cloe

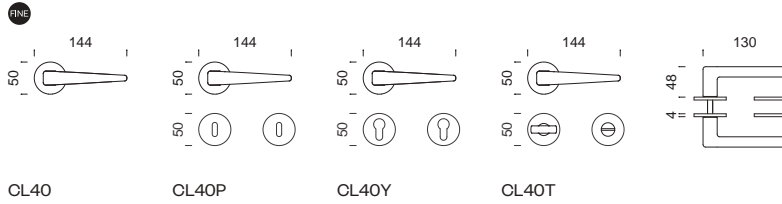

cloe 02

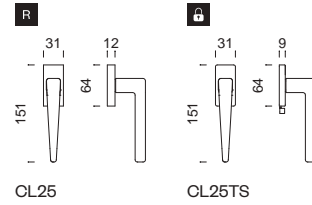
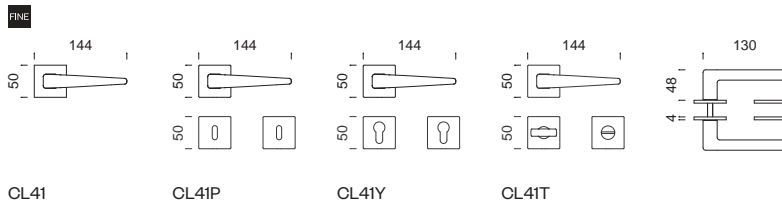
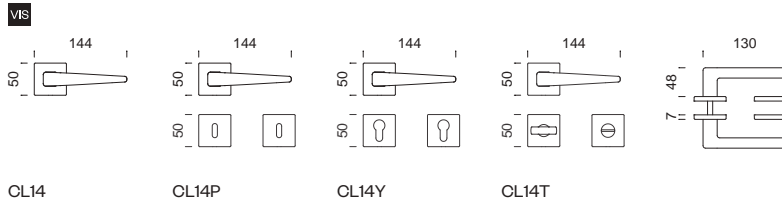

crisalide NEW

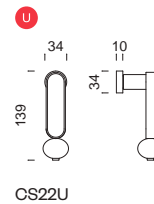
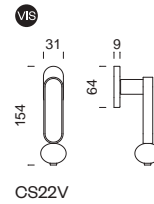
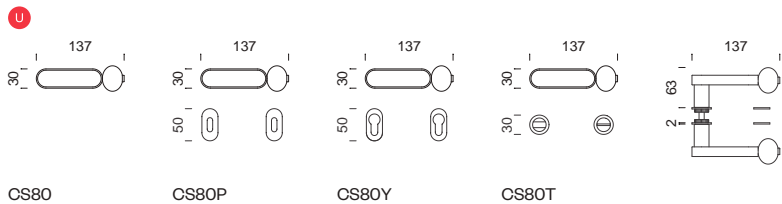
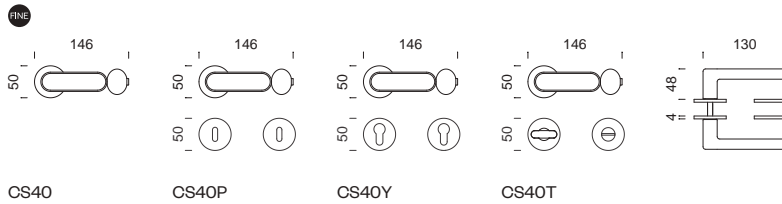

crisalide mini NEW

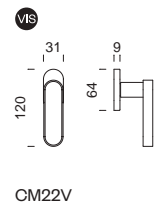
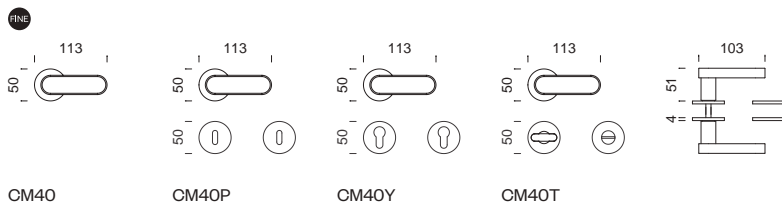

crislide mini NEW

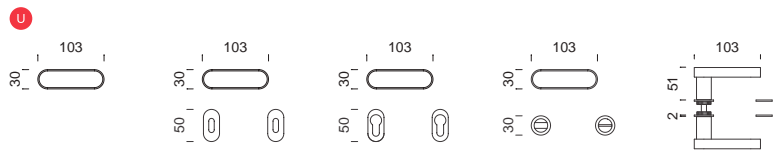

CM80 CM80P CM80Y CM80T

disegni tecnici *technical drawings*

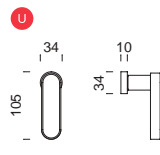

CM22U

daniela

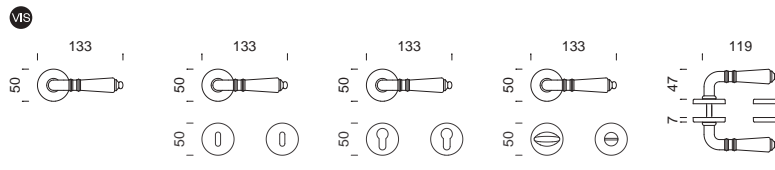

391/12 391/12P 391/12Y 391/12T

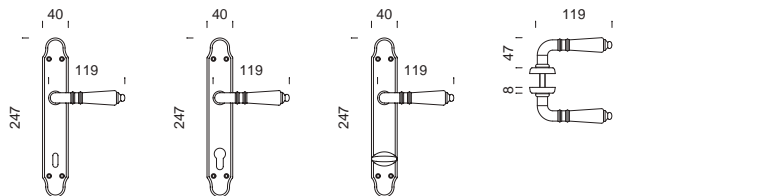

390P 390Y 390T

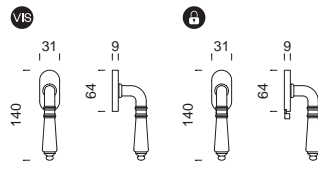

396V 396TS

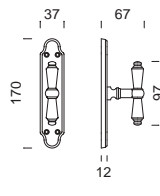

394 395

denise

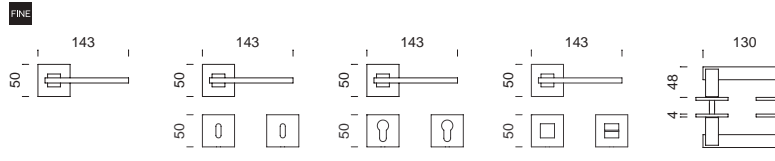

11/41 11/41P 11/41Y 11/41T

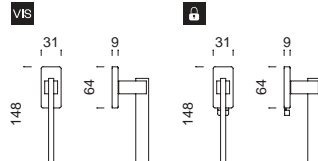

11V 11TS

dolce

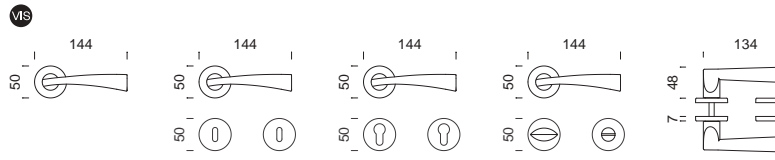

DO12 DO12P DO12Y DO12T

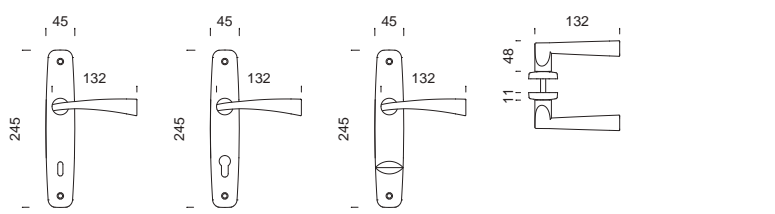

DO10P DO10Y DO10T

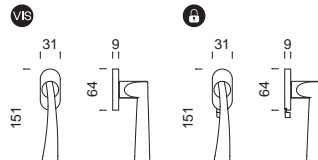

DO22V DO22TS

dolce

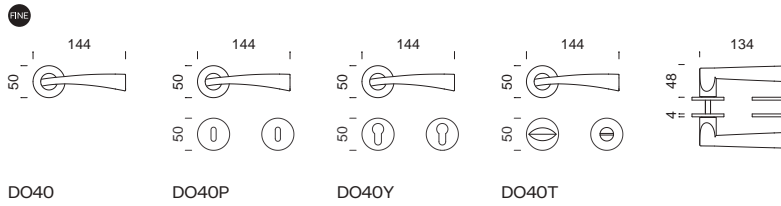

DO40 DO40P DO40Y DO40T

drop

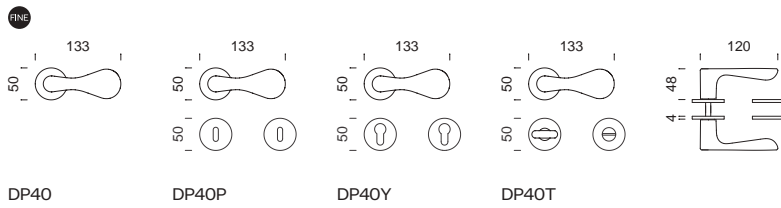

DP40 DP40P DP40Y DP40T

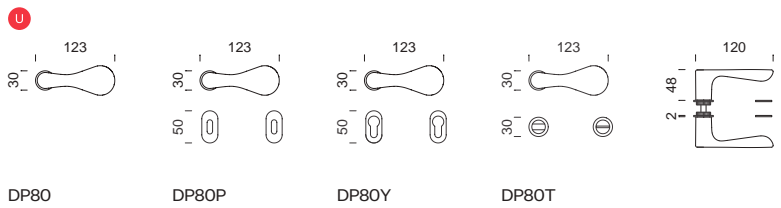

DP80 DP80P DP80Y DP80T

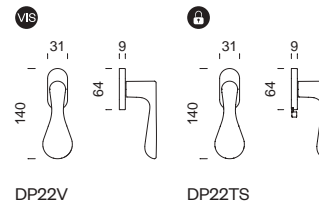

DP22V DP22TS

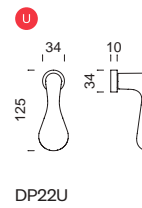

DP22U

DUE

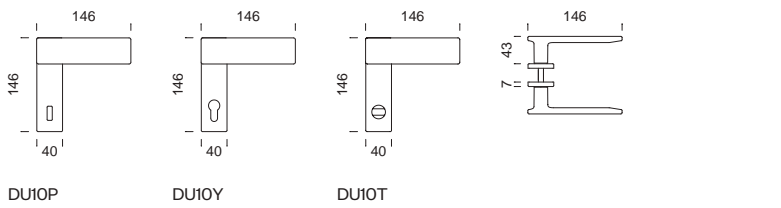

DU10P DU10Y DU10T

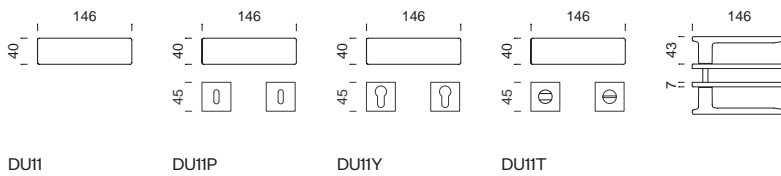

DU11 DU11P DU11Y DU11T

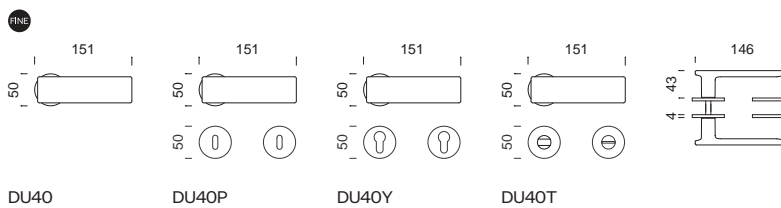

DU40 DU40P DU40Y DU40T

DUE

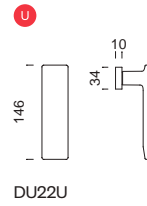
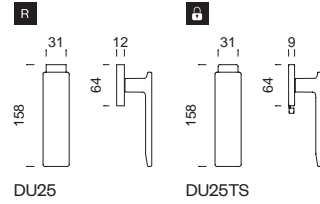
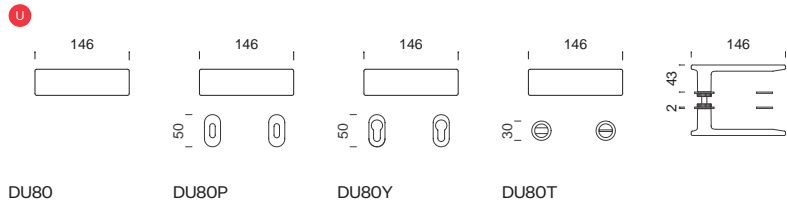
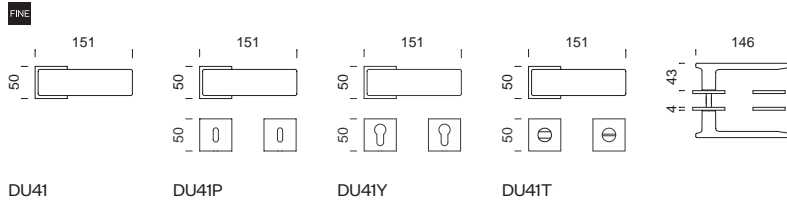

dune **NEW**

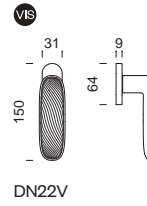
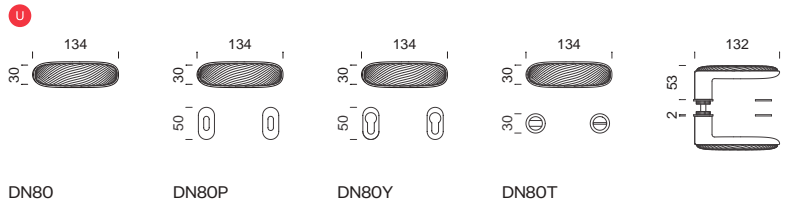
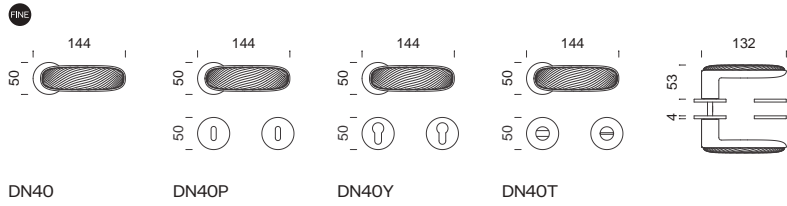

edra 02

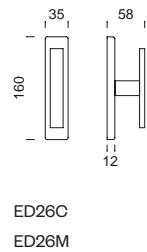
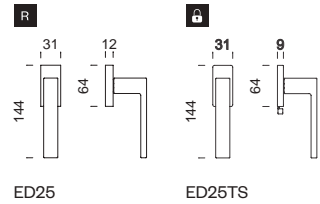
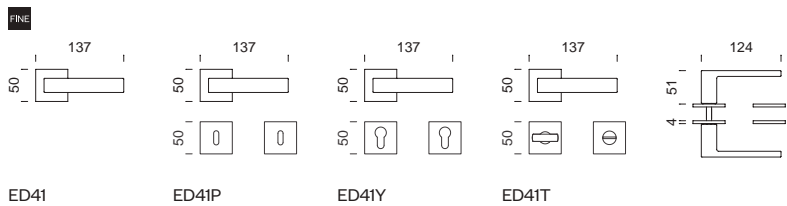
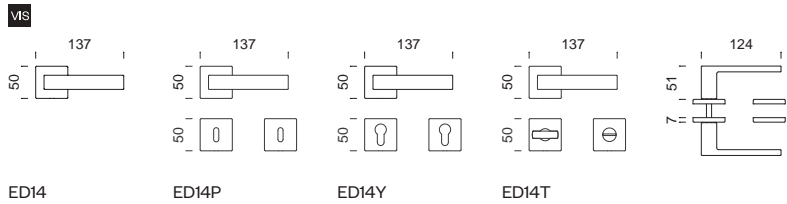

elena

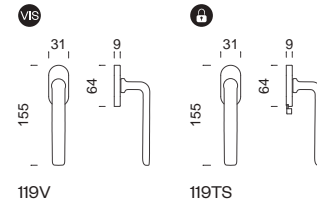
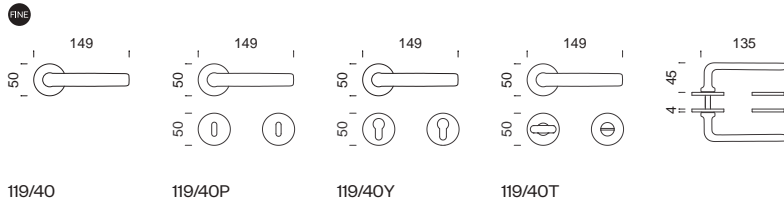
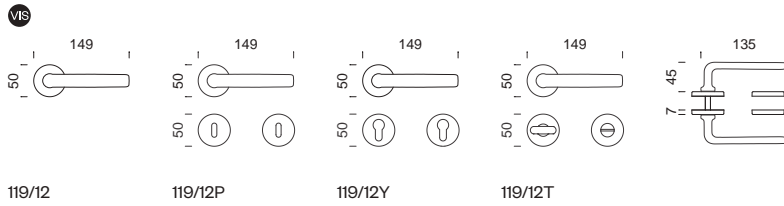

eleonora

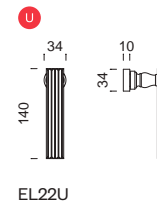
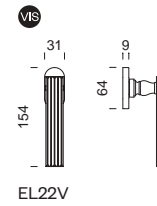
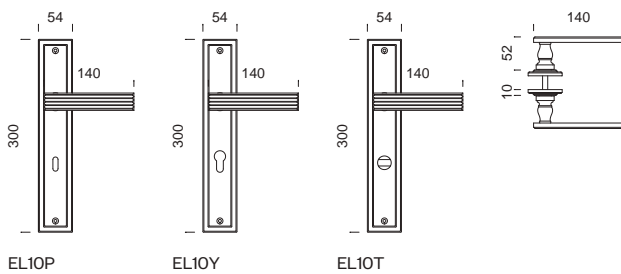
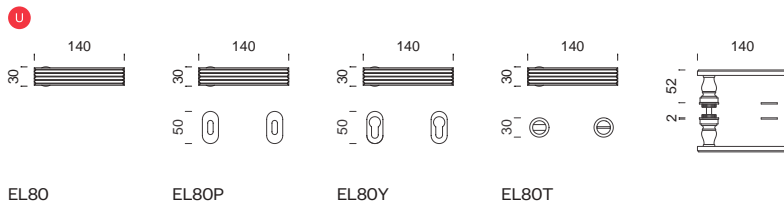
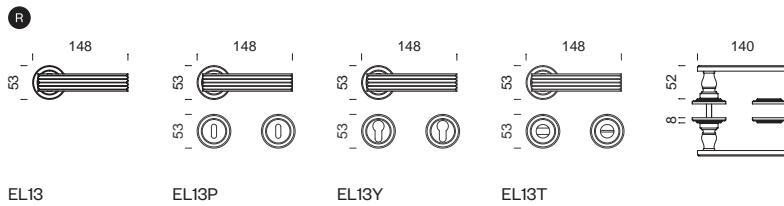
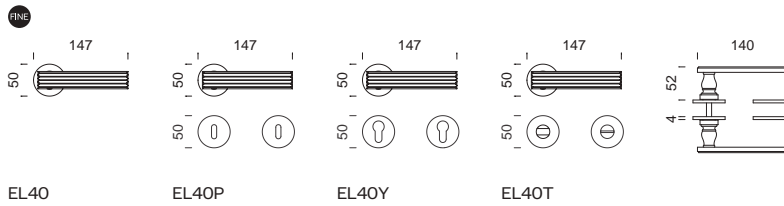

eleonora 02

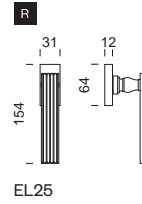
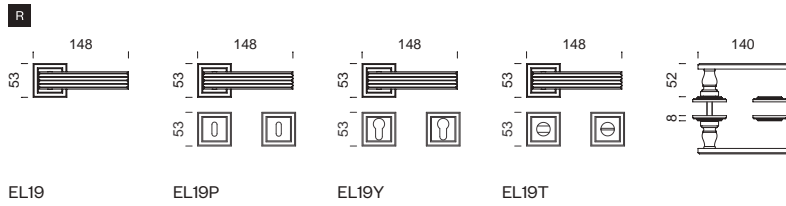
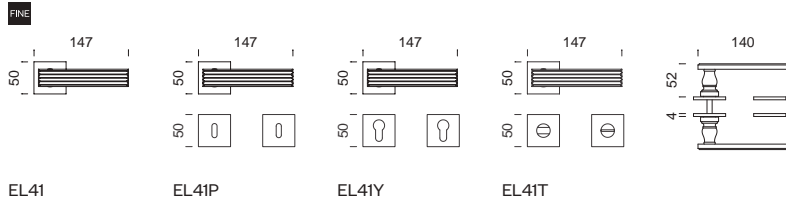

elle ^{new}

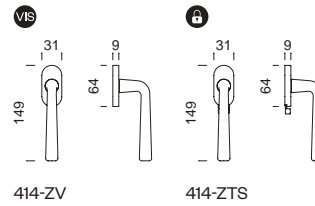
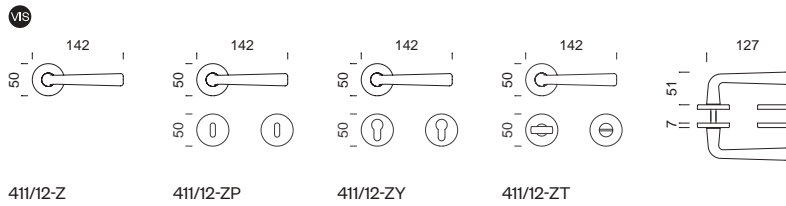

esa

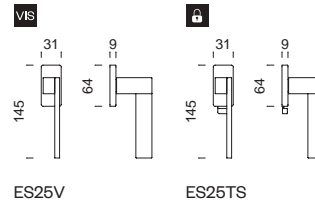
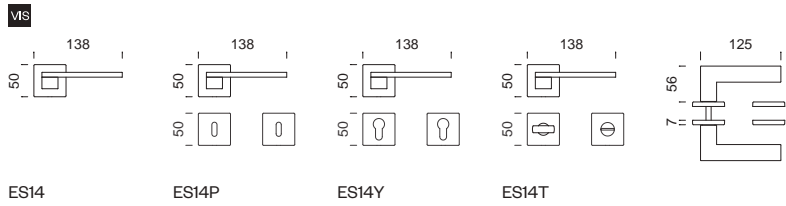

fedora

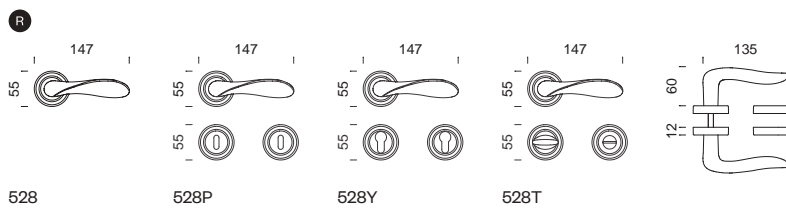
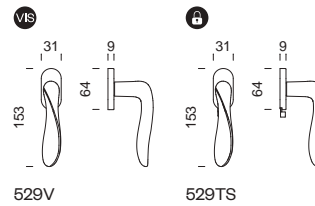
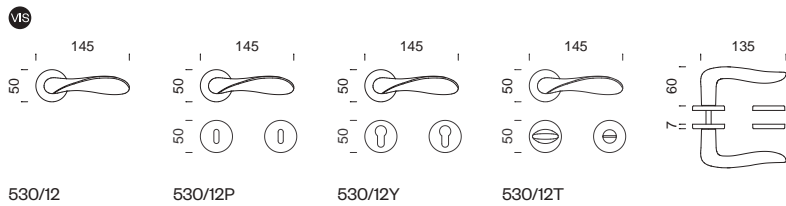

fiore

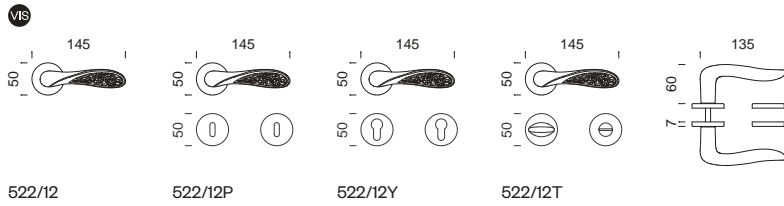

522/12 522/12P 522/12Y 522/12T

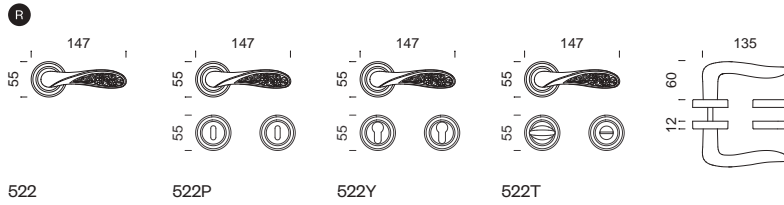

522 522P 522Y 522T

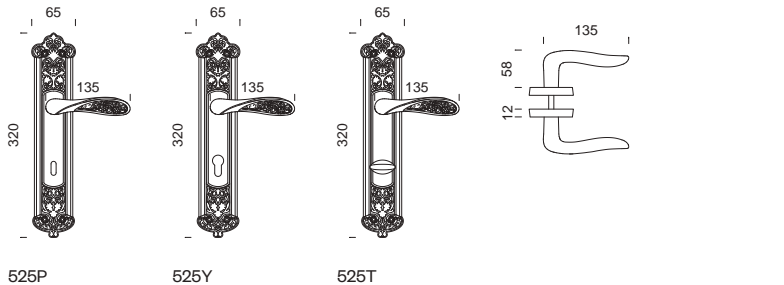

525P 525Y 525T

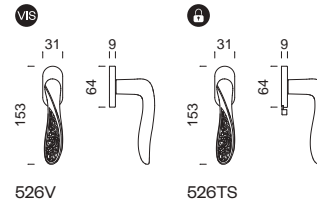

526V 526TS

fiorenza

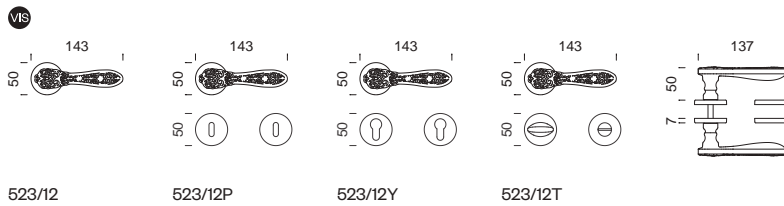

523/12 523/12P 523/12Y 523/12T

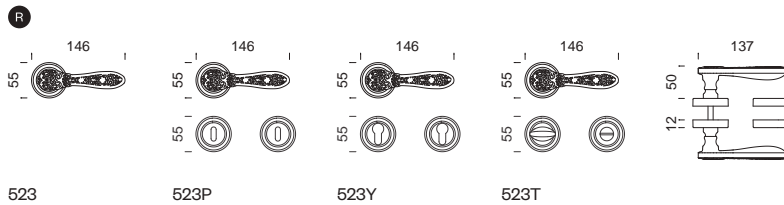

523 523P 523Y 523T

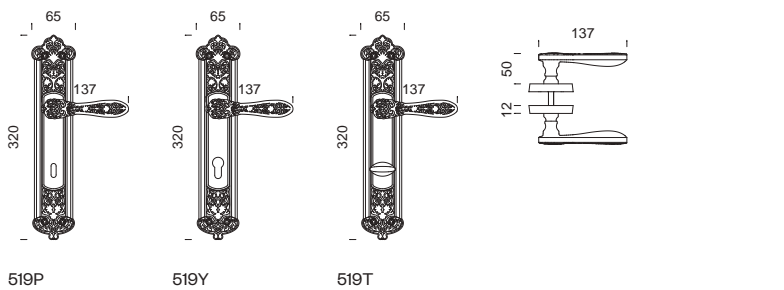

519P 519Y 519T

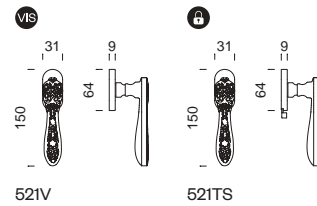

521V 521TS

fluke

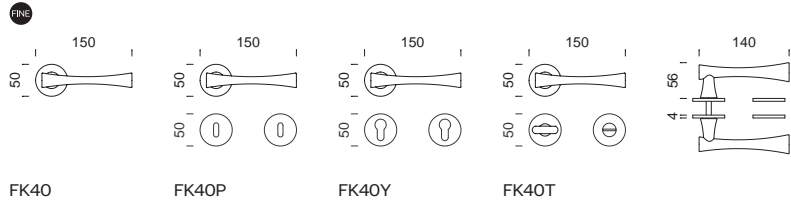

FK40

FK40P

FK40Y

FK40T

FK40TS

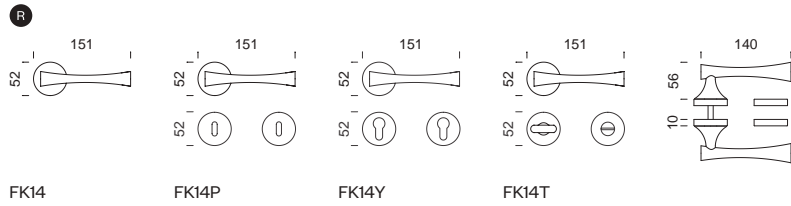

FK14

FK14P

FK14Y

FK14T

FK14TS

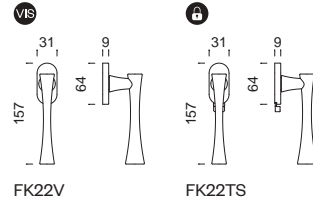

FK22V

FK22TS

fluò

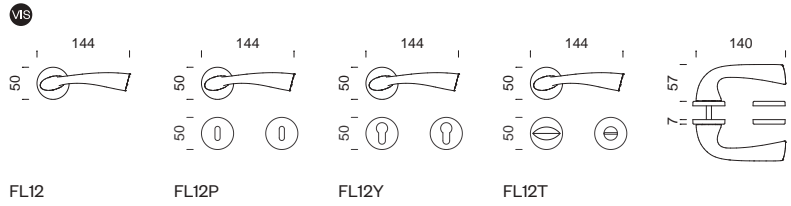

FL12

FL12P

FL12Y

FL12T

FL12TS

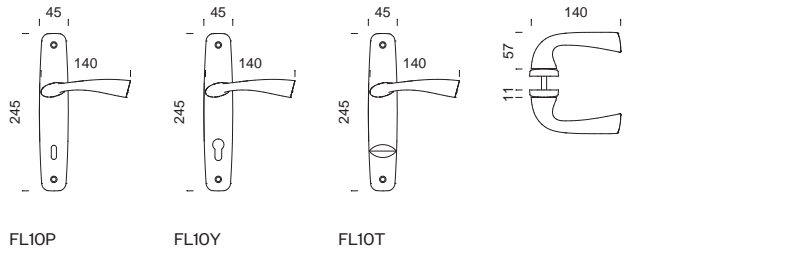

FL10P

FL10Y

FL10T

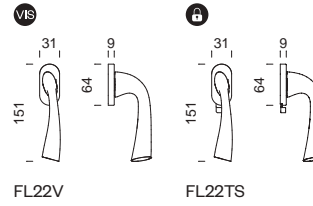

FL22V

FL22TS

fold

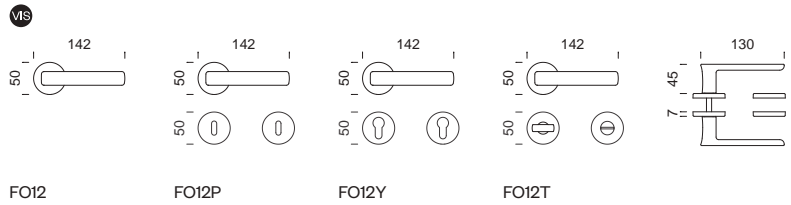

FO12

FO12P

FO12Y

FO12T

FO12TS

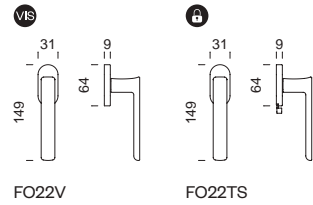

FO22V

FO22TS

fold 02

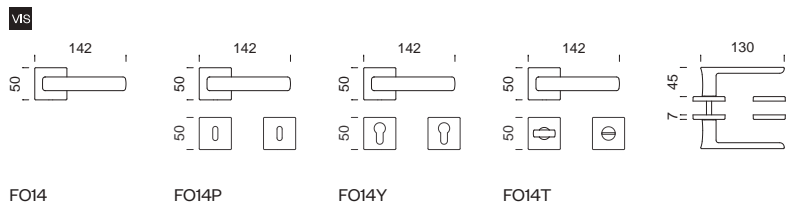

FO14

FO14P

FO14Y

FO14T

FO14TS

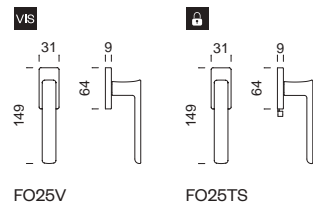

FO25V

FO25TS

freely

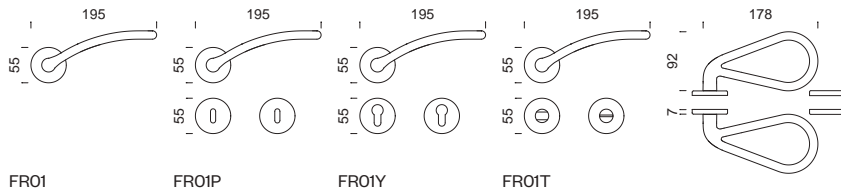

FR01 FR01P FR01Y FR01T

ginevra

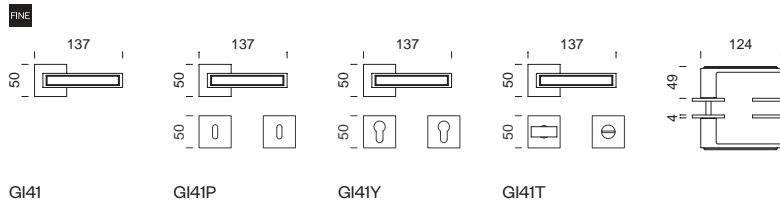

GI41 GI41P GI41Y GI41T

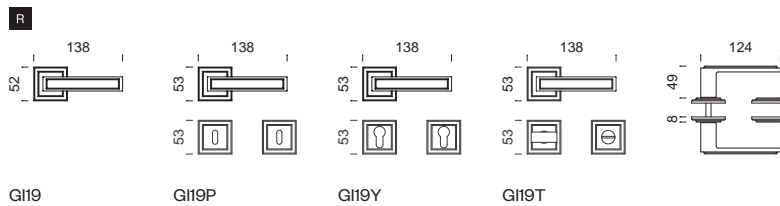

GI19 GI19P GI19Y GI19T

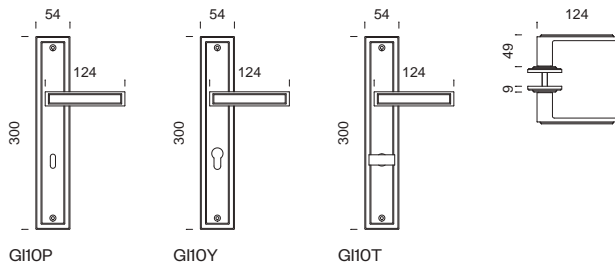

GI10P GI10Y GI10T

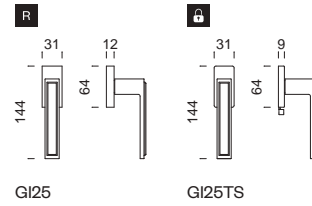

GI25 GI25TS

ginkgo

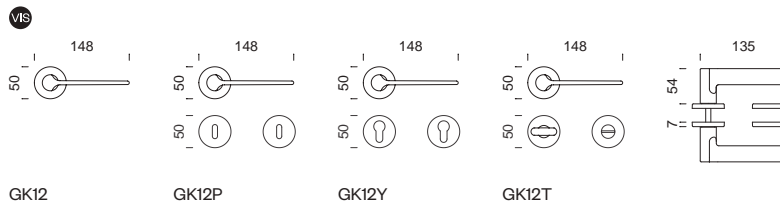

GK12 GK12P GK12Y GK12T

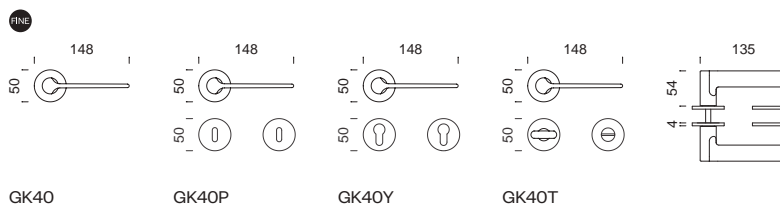

GK40 GK40P GK40Y GK40T

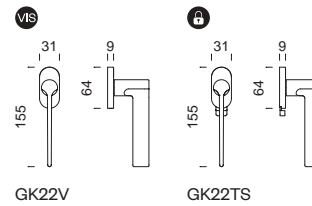

GK22V GK22TS

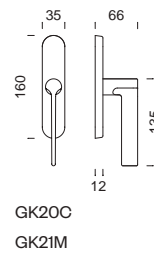

GK20C
GK21M

ginkgo

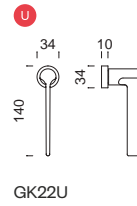
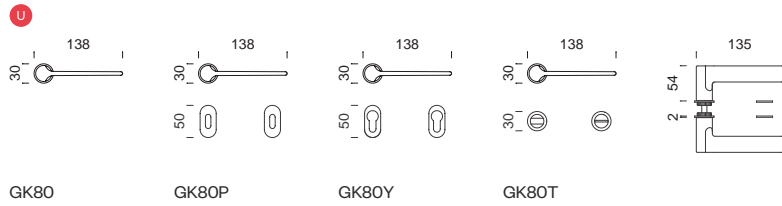

ginkgo biloba

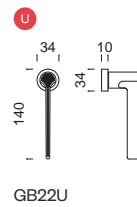
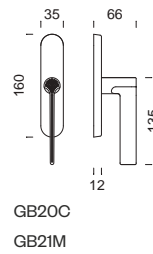
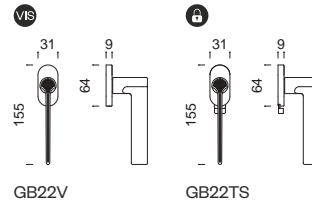
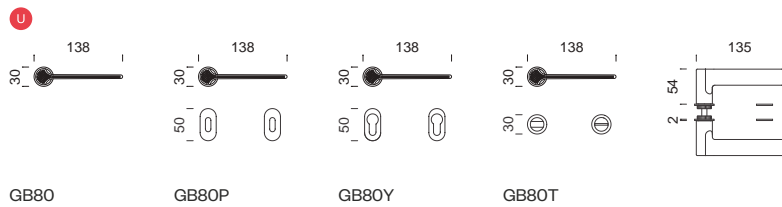
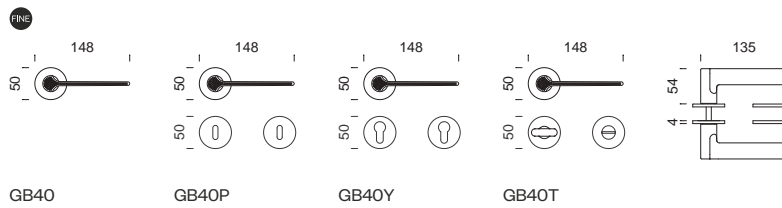
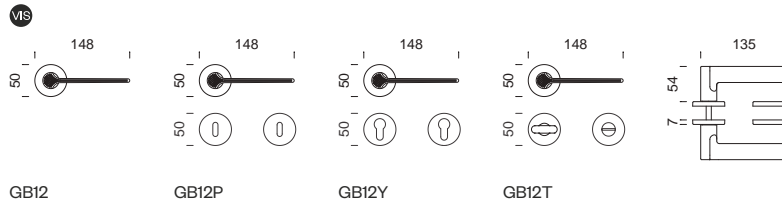

go

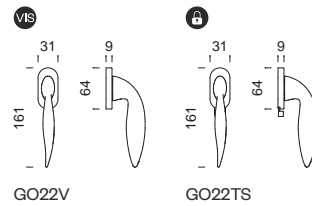
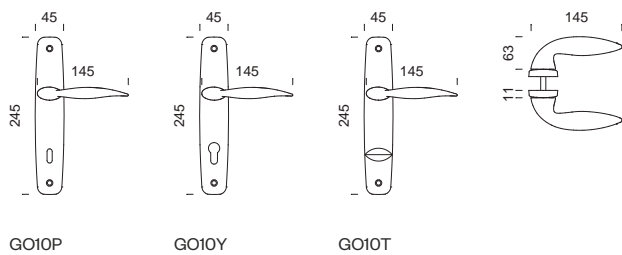
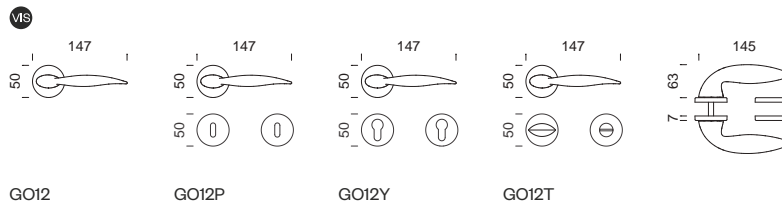

havana

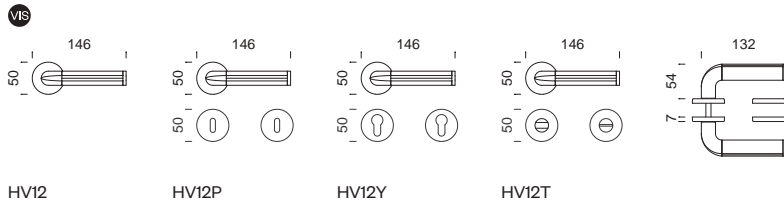

HV12 HV12P HV12Y HV12T

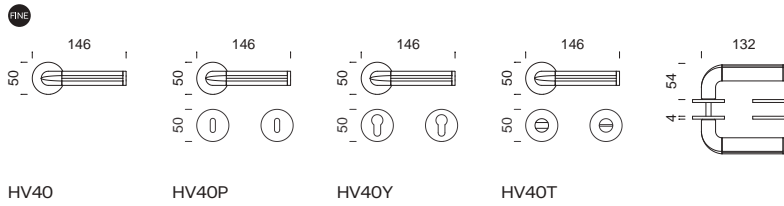

HV40 HV40P HV40Y HV40T

holly

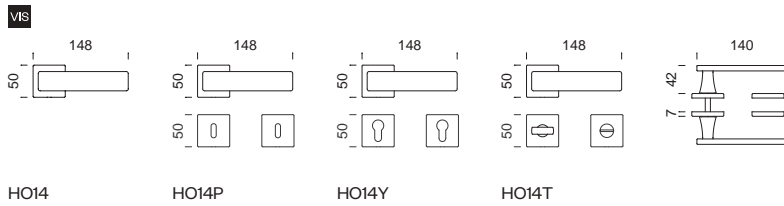

HO14 HO14P HO14Y HO14T

iki

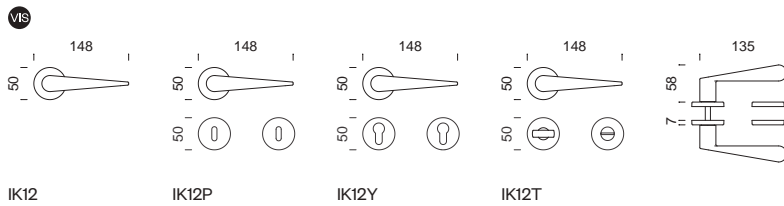

IK12 IK12P IK12Y IK12T

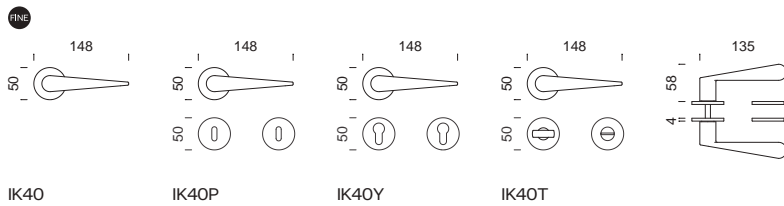

IK40 IK40P IK40Y IK40T

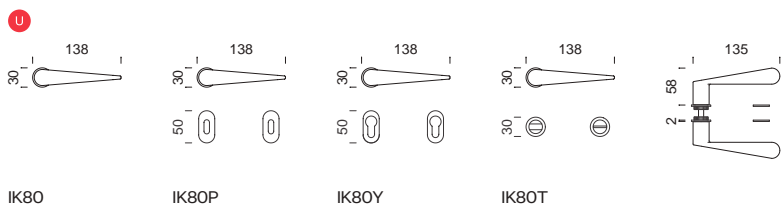

IK80 IK80P IK80Y IK80T

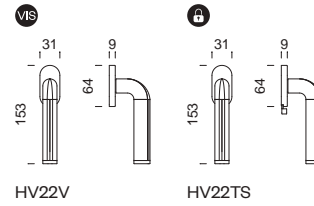

HV22V HV22TS

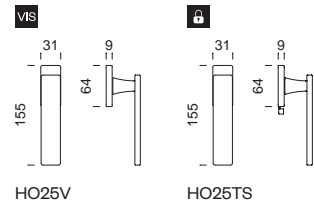

HO25V HO25TS

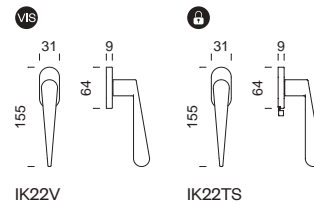

IK22V IK22TS

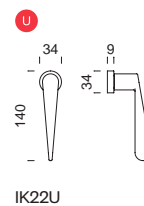

IK22U

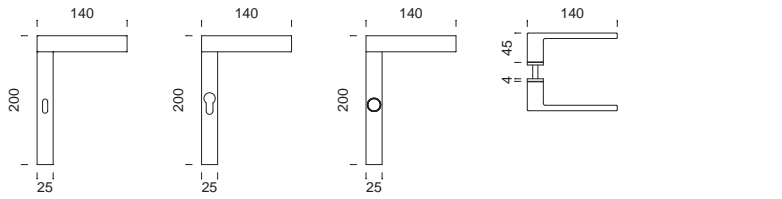

IF10P IF10Y IF10T

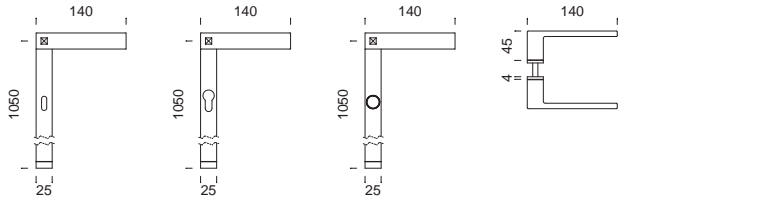

IF10/LP IF10/LY IF10/LT

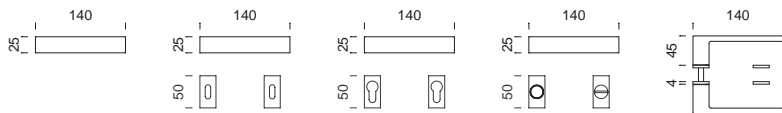

IF01 IF01P IF01Y IF01T

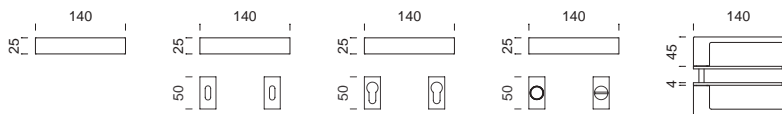

IF11 IF11P IF11Y IF11T

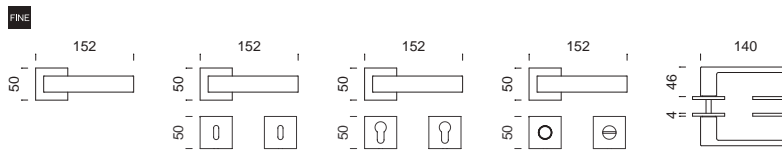

IF41 IF41P IF41Y IF41T

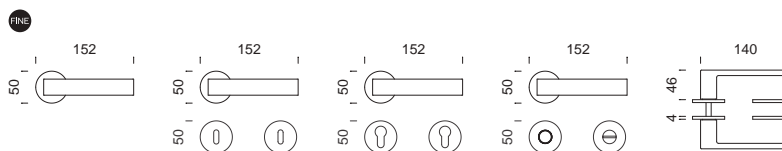

IF40 IF40P IF40Y IF40T

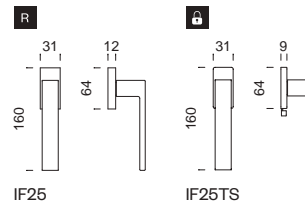

IF25 IF25TS

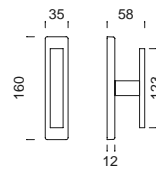

ED26C
ED26M

intake

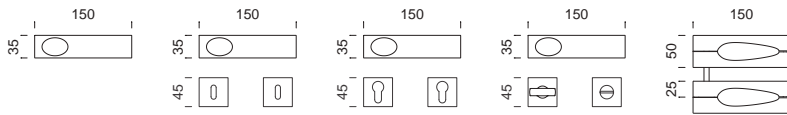

INI4 INI4P INI4Y INI4T INI4T

isabella

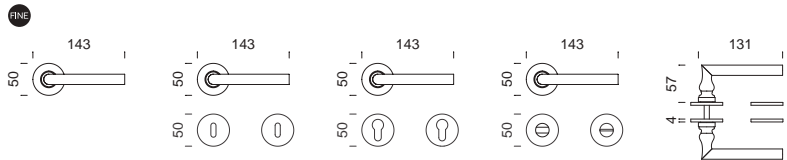

IS40 IS40P IS40Y IS40T IS22V

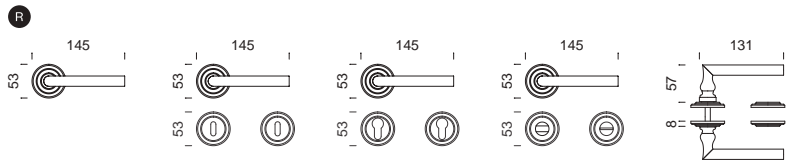

IS13 IS13P IS13Y IS13T IS22TS

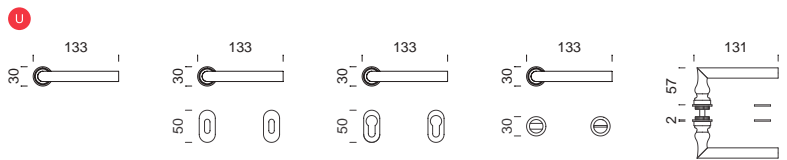

IS80 IS80P IS80Y IS80T IS20C

joy

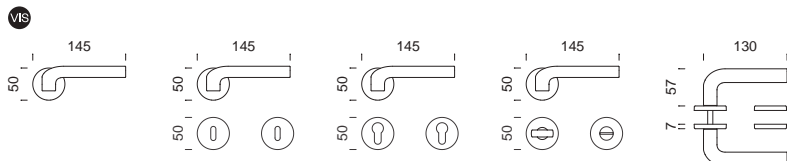

JO12 JO12P JO12Y JO12T IS21M

joy 02

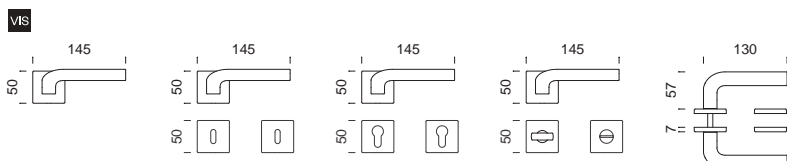

JO14 JO14P JO14Y JO14T IS22U

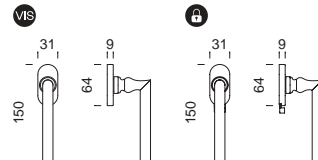

IS22V IS22TS

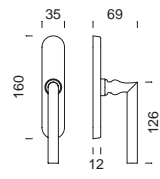

IS20C
IS21M

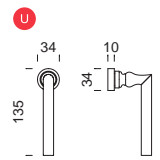

IS22U

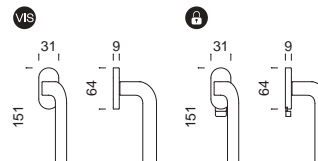

JO22V JO22TS

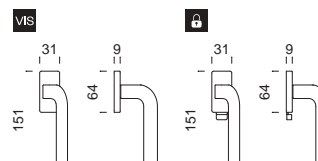

JO25V JO25TS

lady

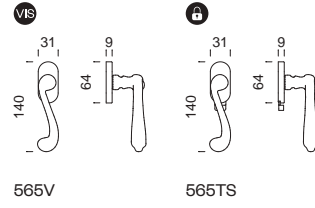
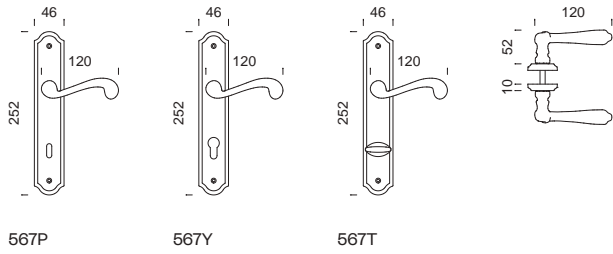
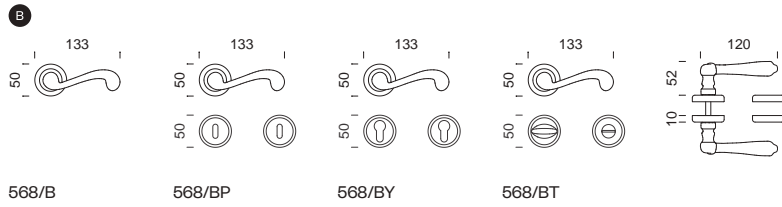
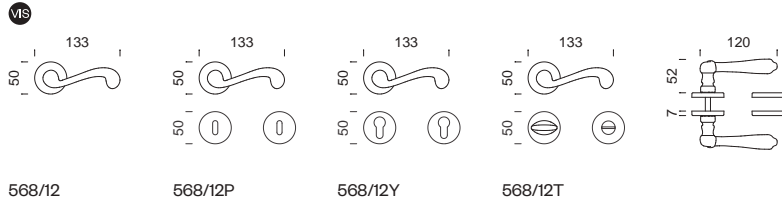

latina

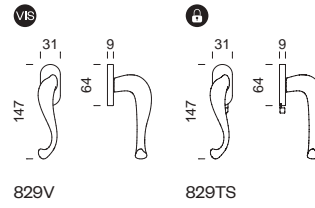
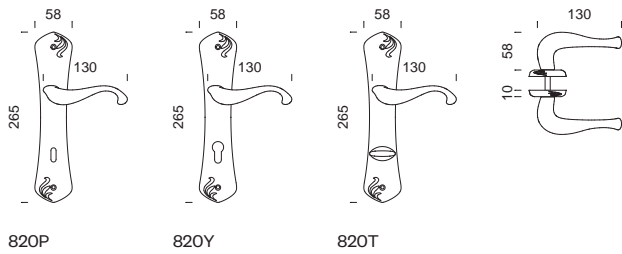
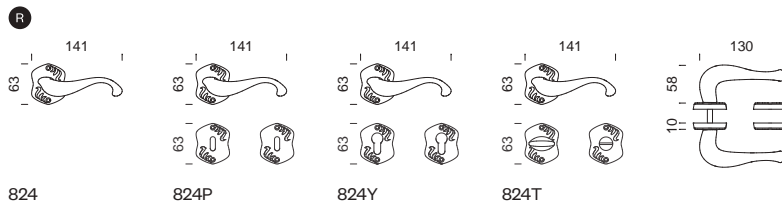
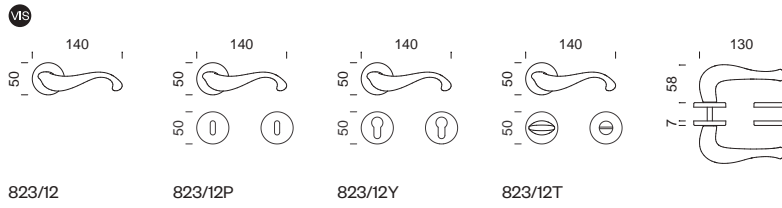

leva NEW

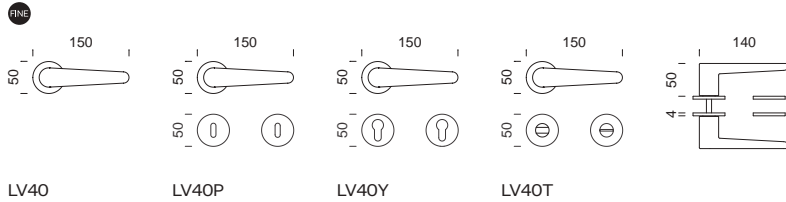

LV40 LV40P LV40Y LV40T

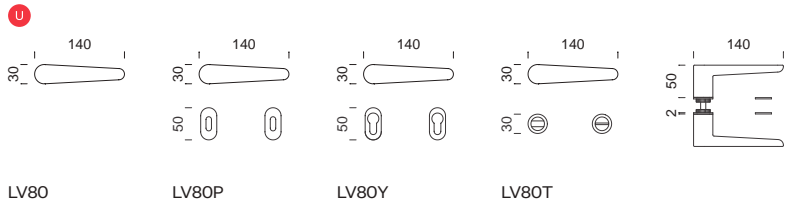

LV80 LV80P LV80Y LV80T

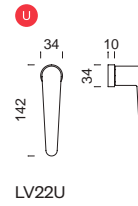

LV22U

leva mirror NEW

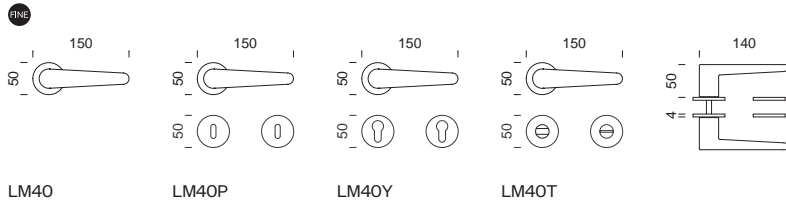

LM40 LM40P LM40Y LM40T

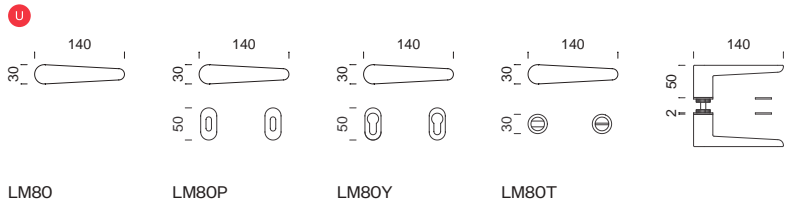

LM80 LM80P LM80Y LM80T

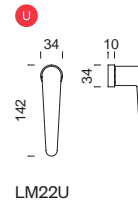

LM22U

levante

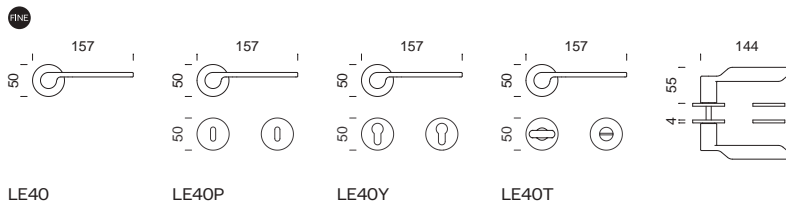

LE40 LE40P LE40Y LE40T

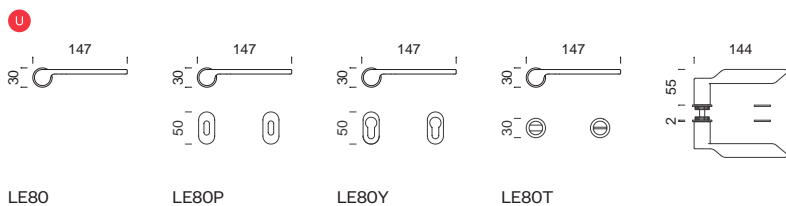

LE80 LE80P LE80Y LE80T

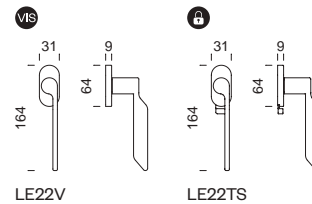

LE22V LE22TS

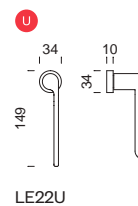

LE22U

linear

VIS

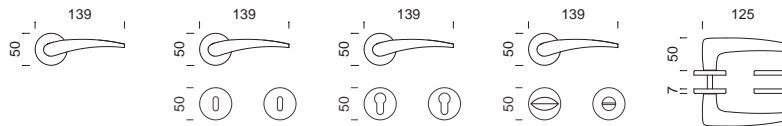

LI12

LI12P

LI12Y

LI12T

VIS

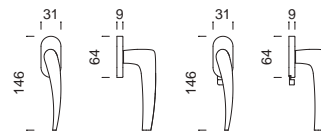

LI22V

LI22TS

FINE

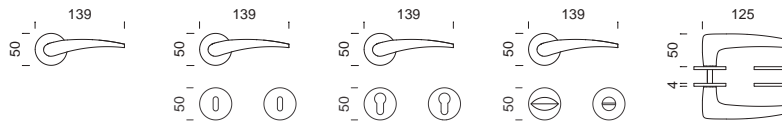

LI40

LI40P

LI40Y

LI40T

U

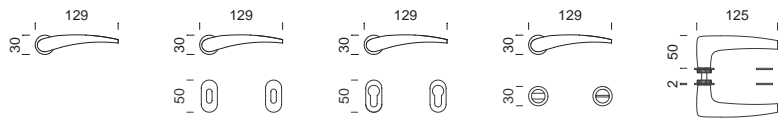

LI80

LI80P

LI80Y

LI80T

U

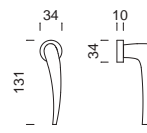

LI22U

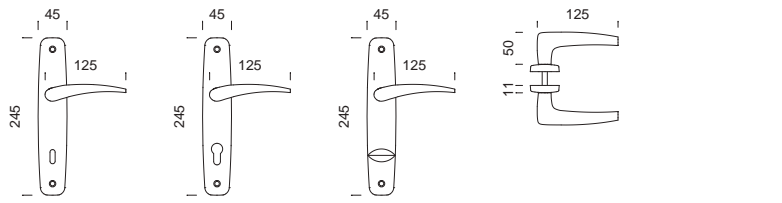

LI10P

LI10Y

LI10T

link

VIS

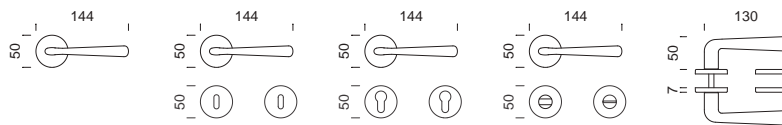

653/12

653/12P

653/12Y

653/12T

VIS

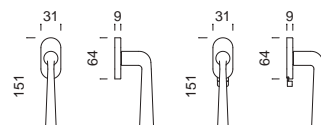

656V

656TS

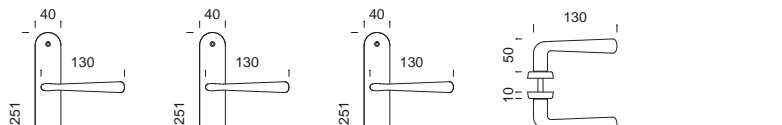

650P

650Y

650T

lirica

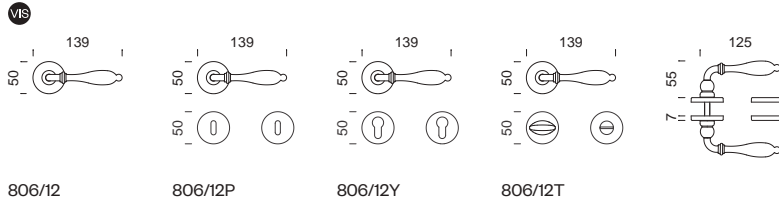

806/12 806/12P 806/12Y 806/12T

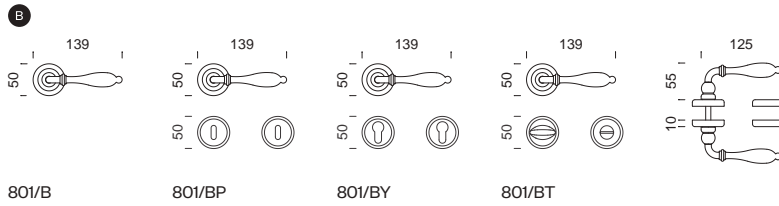

801/B 801/BP 801/BY 801/BT

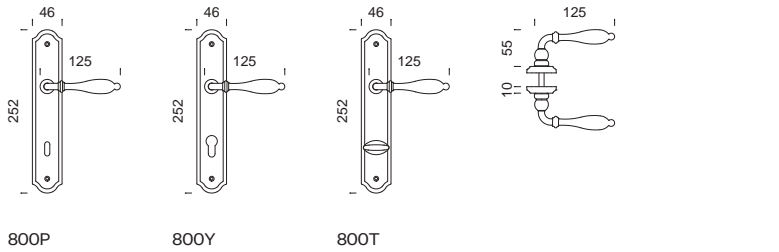

800P 800Y 800T

lorena

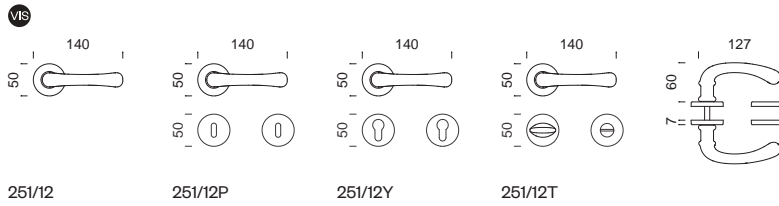

251/12 251/12P 251/12Y 251/12T

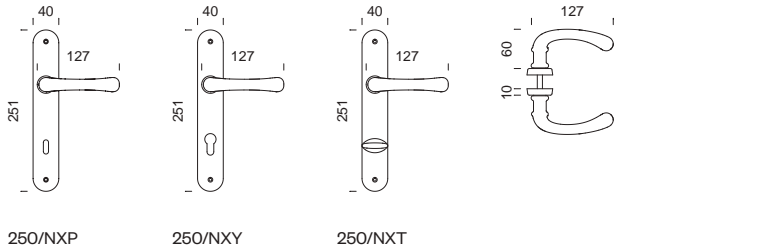

250/NXP 250/NXY 250/NXT

luce

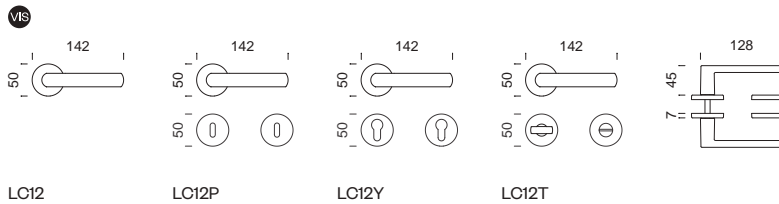

LC12 LC12P LC12Y LC12T

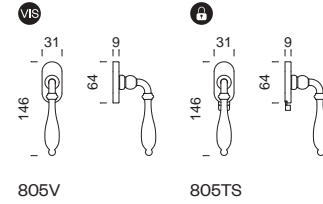

805V 805TS

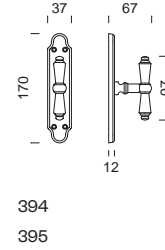

394
395

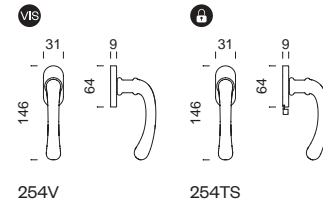

254V 254TS

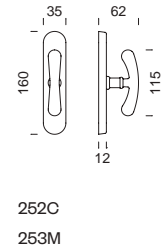

252C
253M

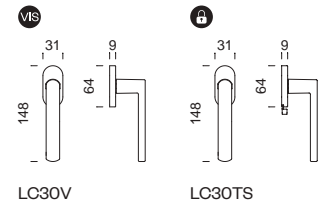

LC30V LC30TS

luce

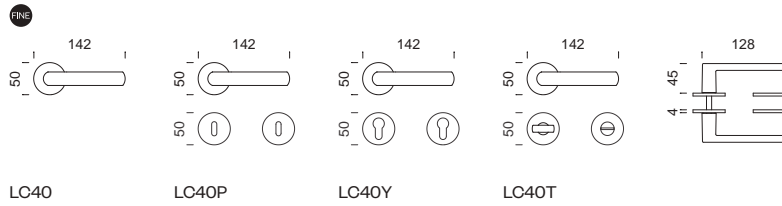

LC40

LC40P

LC40Y

LC40T

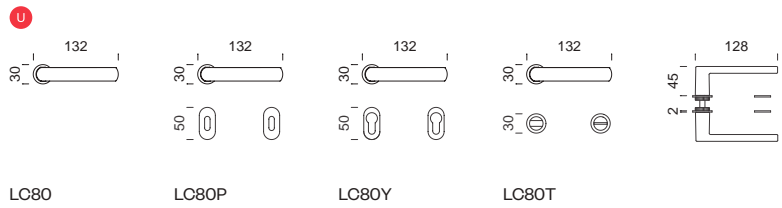

LC80

LC80P

LC80Y

LC80T

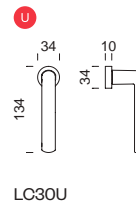

LC30U

luce 02

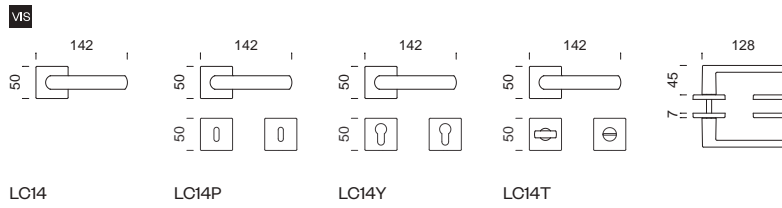

LC14

LC14P

LC14Y

LC14T

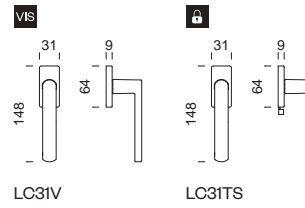

LC31V

LC31TS

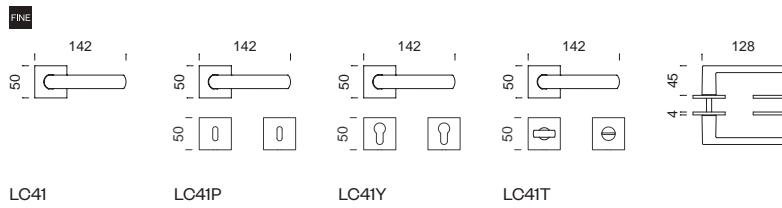

LC41

LC41P

LC41Y

LC41T

luce p

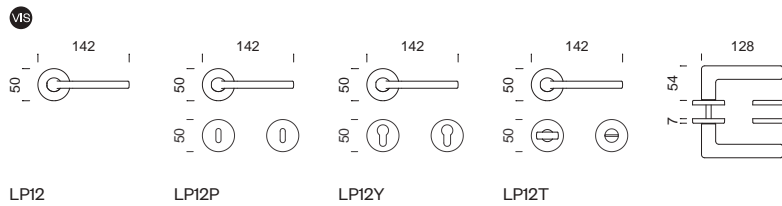

LP12

LP12P

LP12Y

LP12T

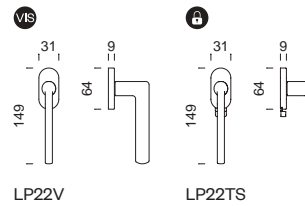

LP22V

LP22TS

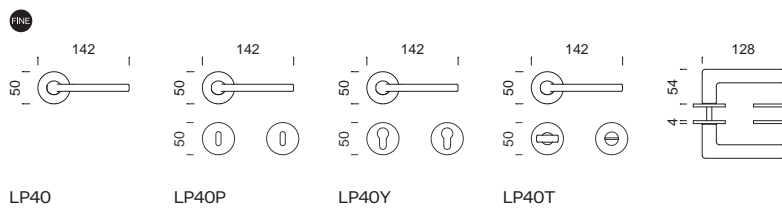

LP40

LP40P

LP40Y

LP40T

luce p

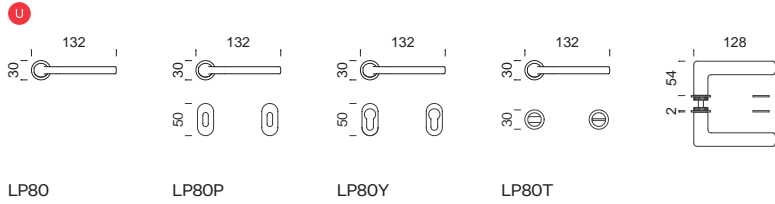

luce p 02

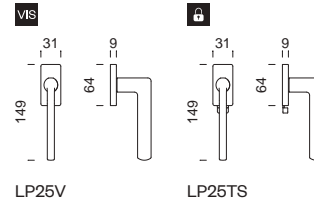
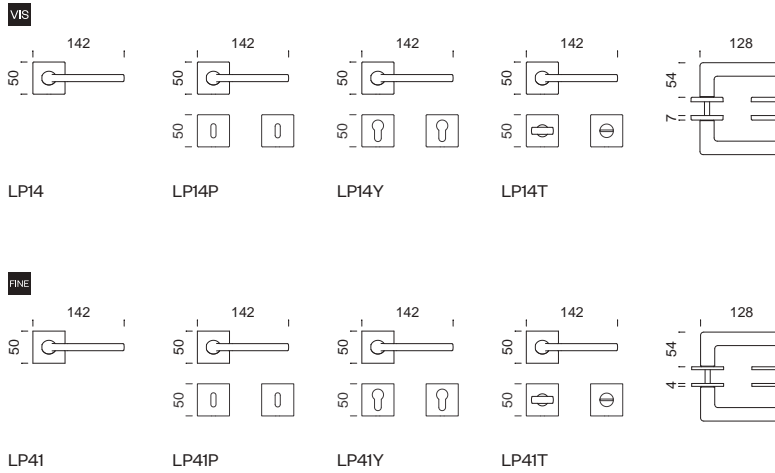

lucrezia

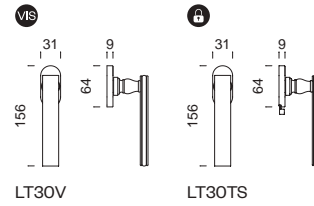
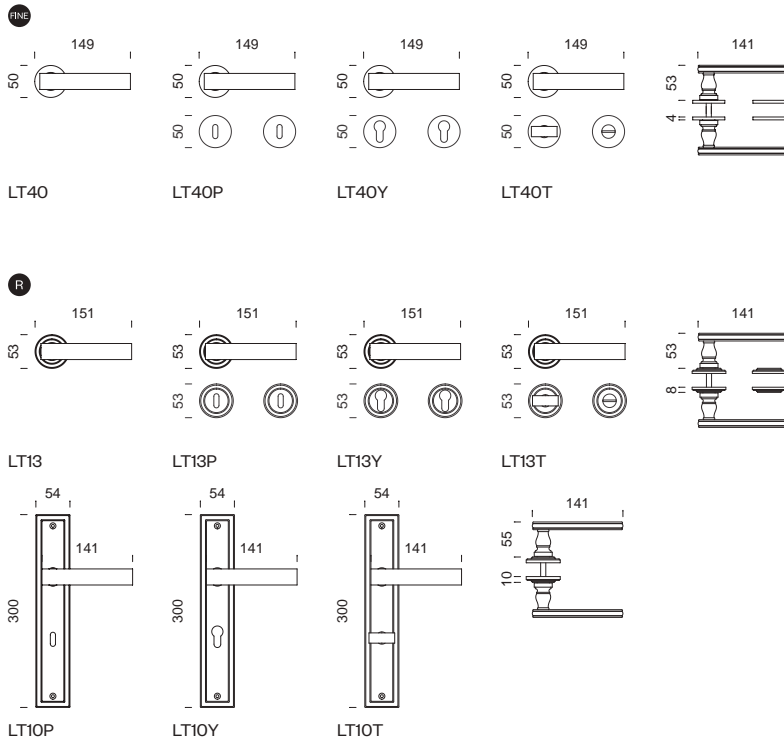

lucrezia O2

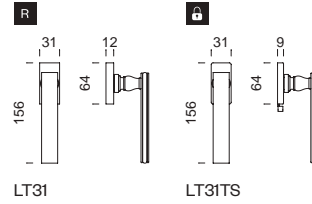
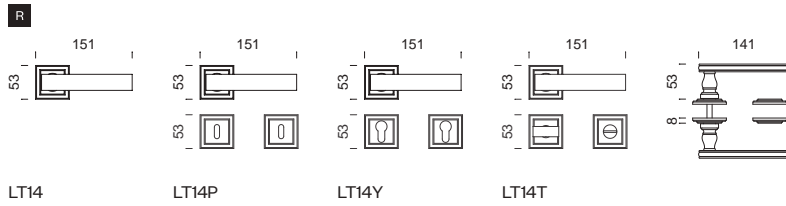
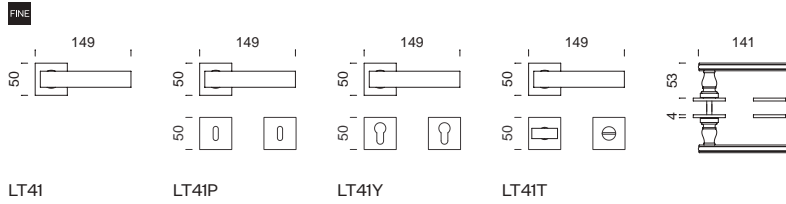

luxury

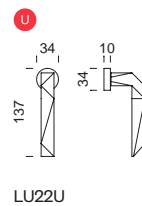
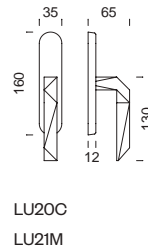
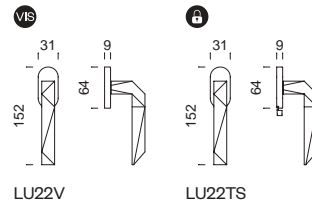
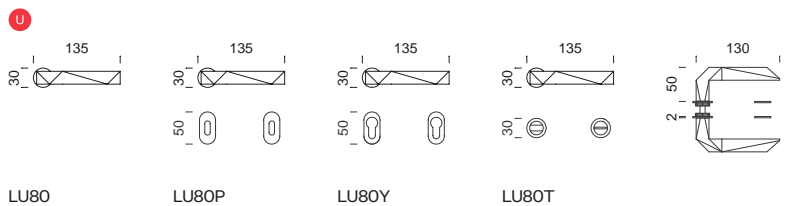
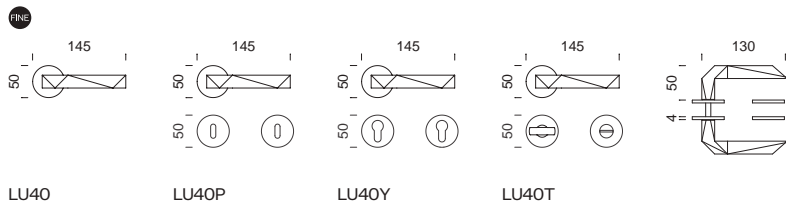
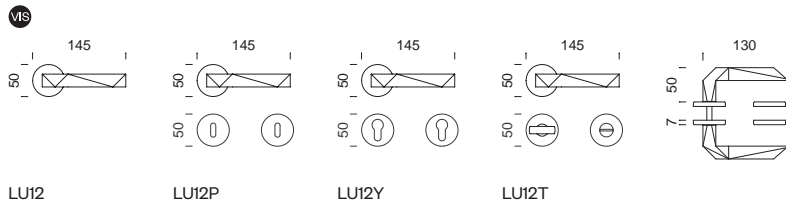

luxury O2

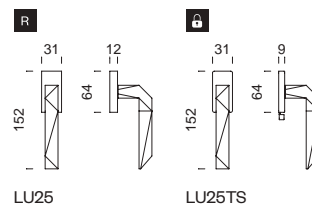
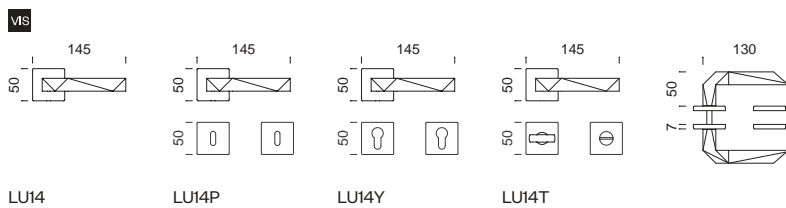

luxury 02

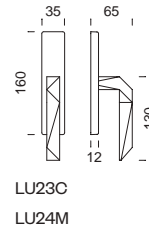
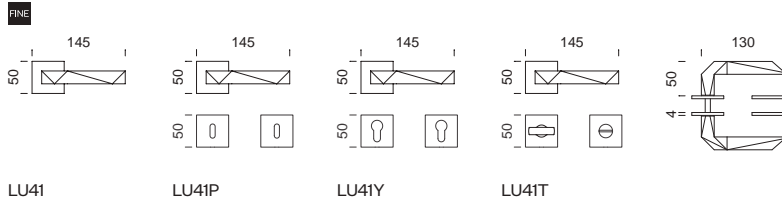

madeleine

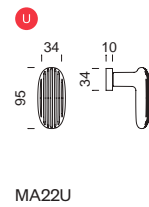
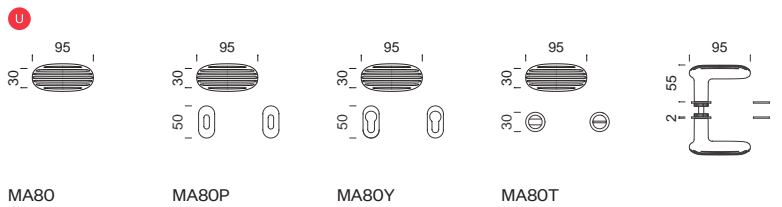
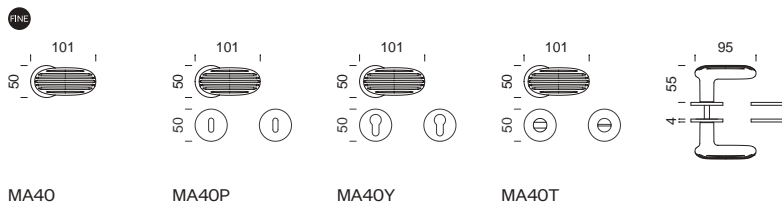
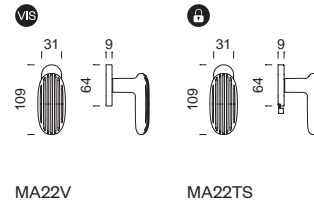
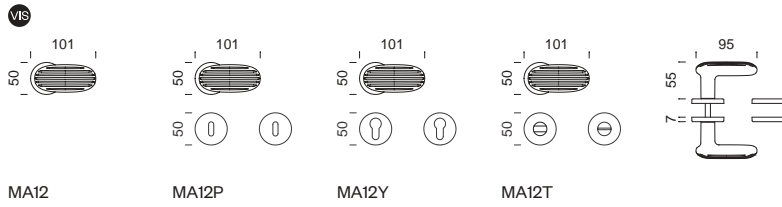

minima

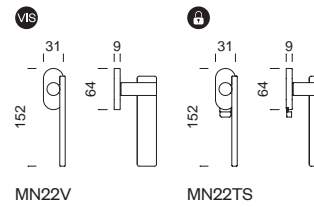
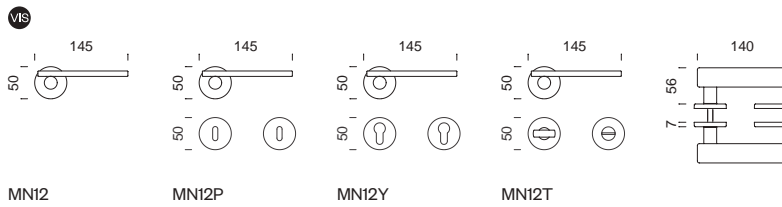

mix

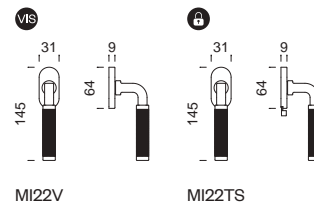
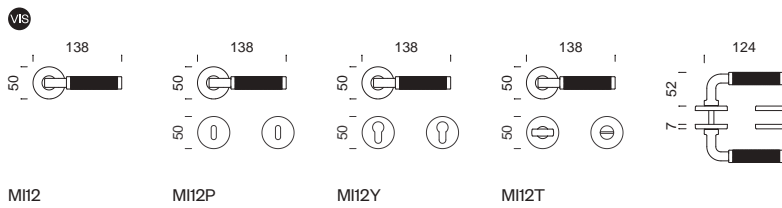

mj

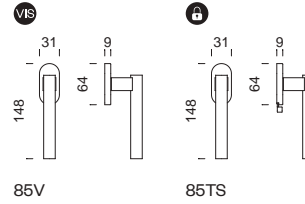
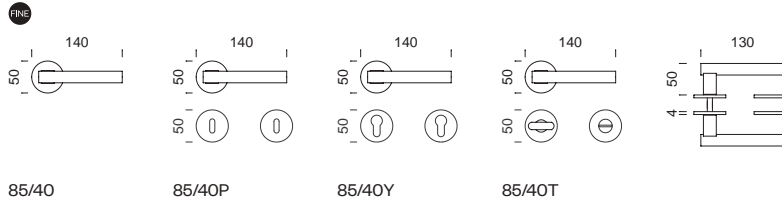

nova

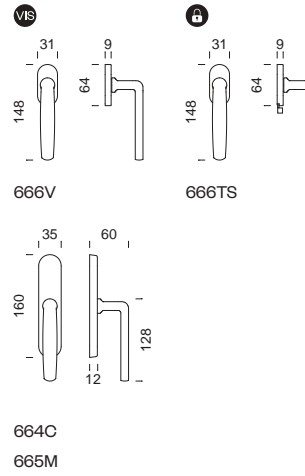
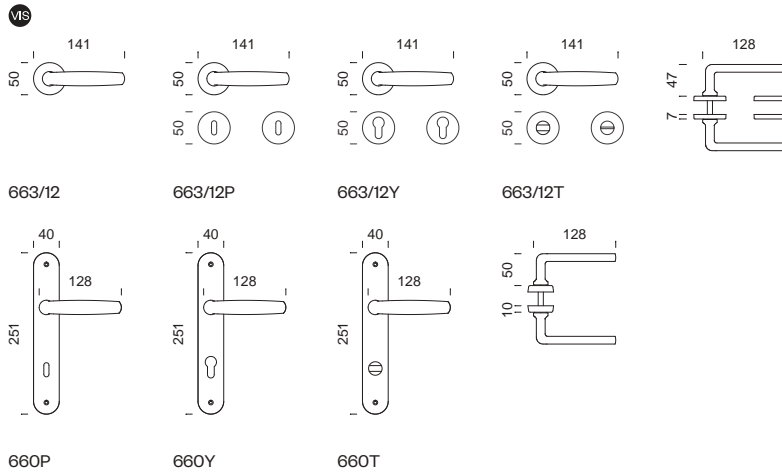

ovum

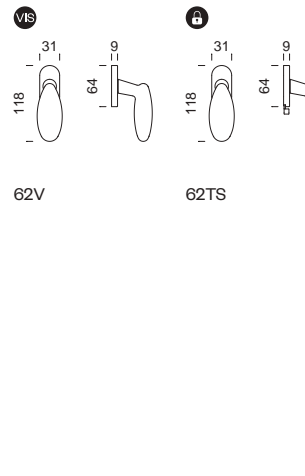
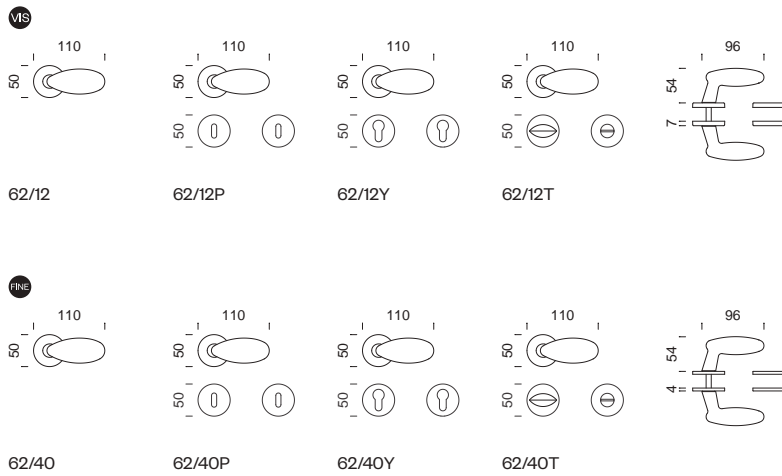

pluris NEW

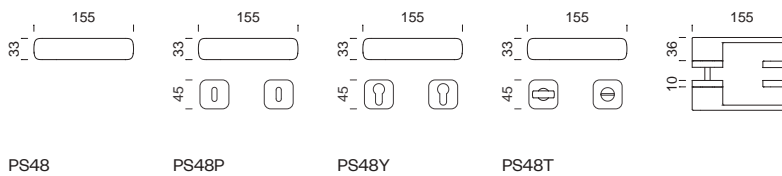

pod

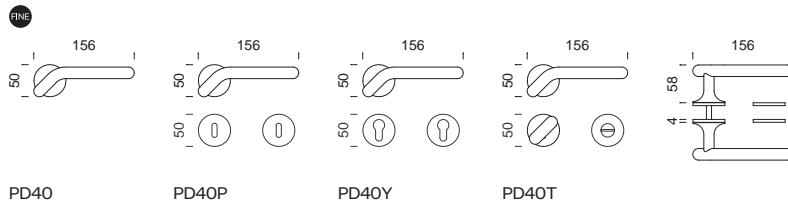

project

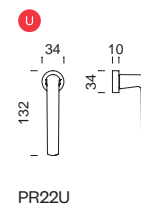
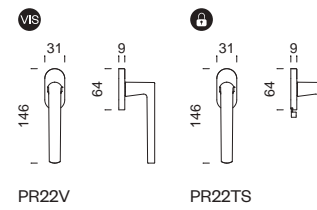
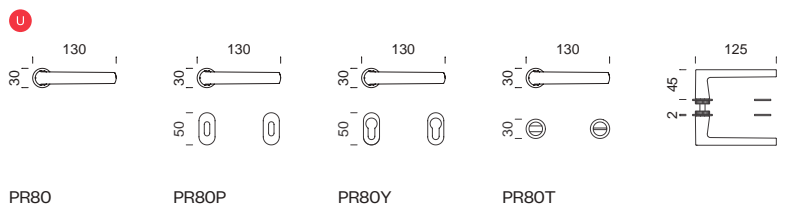
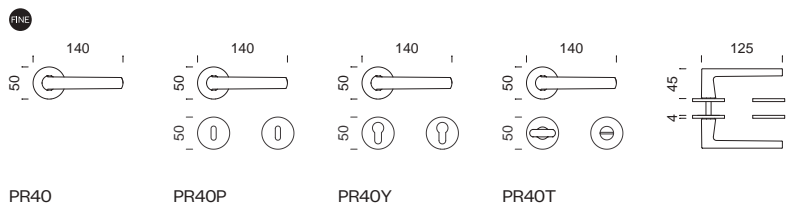
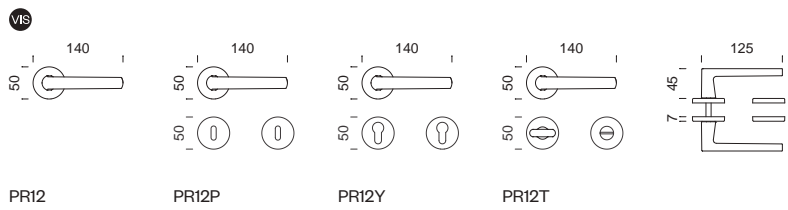

project 02

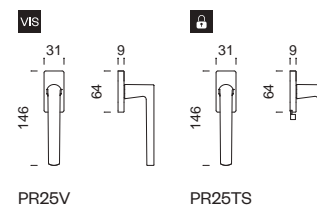
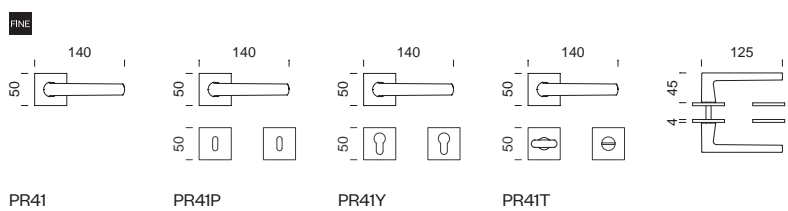
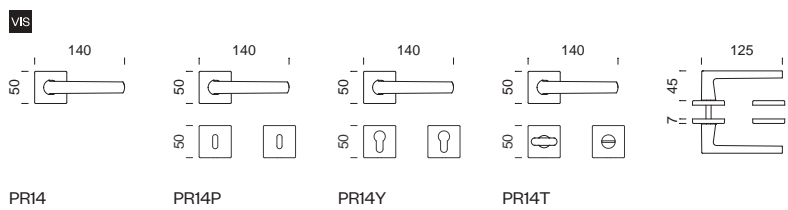

project zancata

VIS

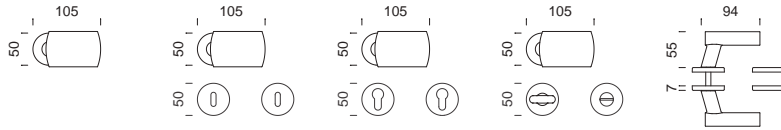

PO12

PO12P

PO12Y

PO12T

project zancata 02

VIS

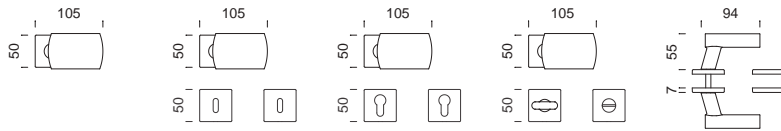

PO14

PO14P

PO14Y

PO14T

quattro 02

VIS

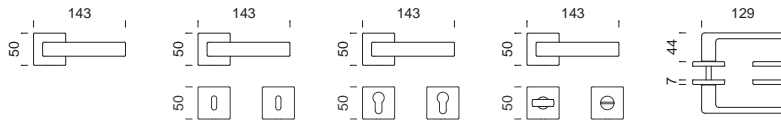

264/14-Z

264/14-ZP

264/14-ZY

264/14-ZT

VIS

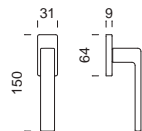

266-ZV

LOCK

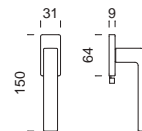

266-ZTS

S40

VIS

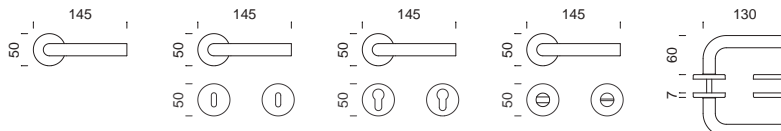

S40/12

S40/12P

S40/12Y

S40/12T

VIS

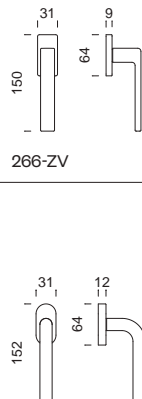

S45

S50

VIS

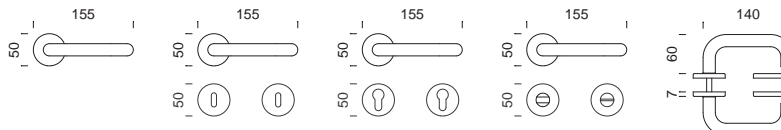

S50/12

S50/12P

S50/12Y

S50/12T

VIS

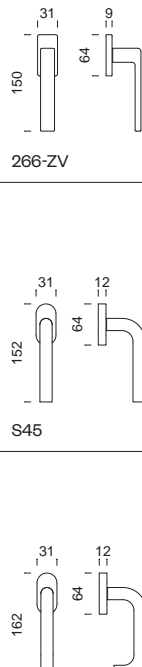

S55

S60

VIS

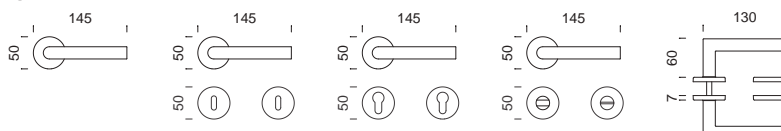

S60/12

S60/12P

S60/12Y

S60/12T

VIS



S65

safety

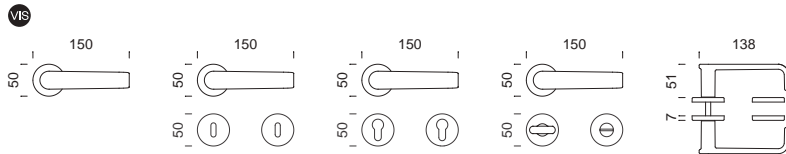

SA12 SA12P SA12Y SA12T

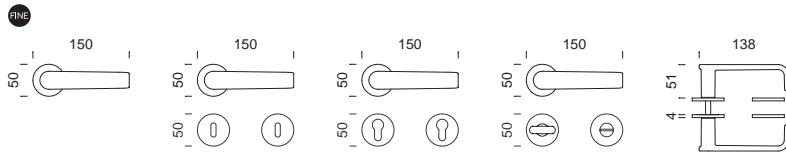

SA40 SA40P SA40Y SA40T

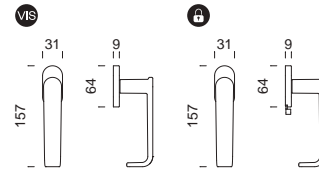

SA22V SA22TS

san

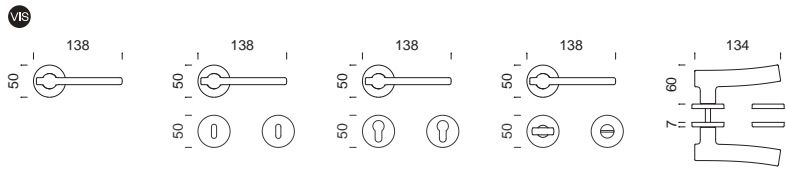

SN12 SN12P SN12Y SN12T

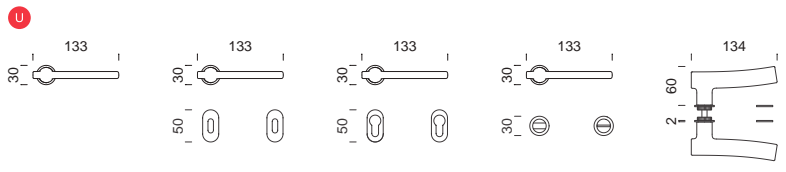

SN80 SN80P SN80Y SN80T

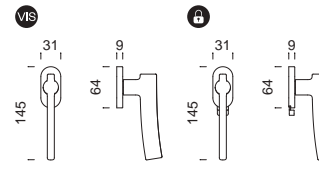

SN22V SN22TS

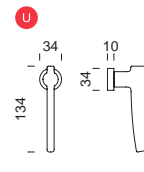

SN22U

san 02

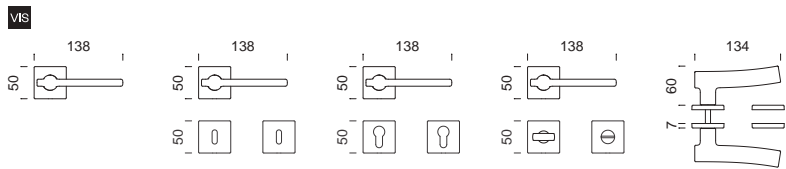

SN14 SN14P SN14Y SN14T

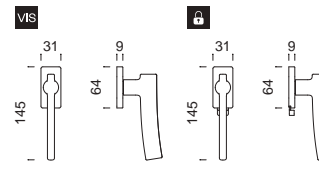

SN25V SN25TS

short

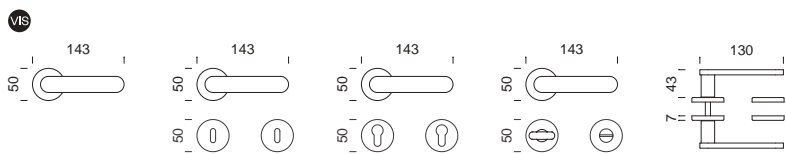

SH12 SH12P SH12Y SH12T

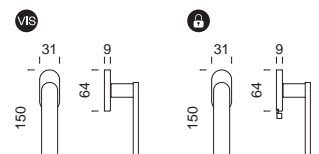

SH22V SH22TS

short

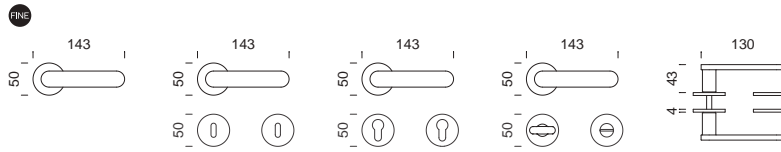

SH40 SH40P SH40Y SH40T

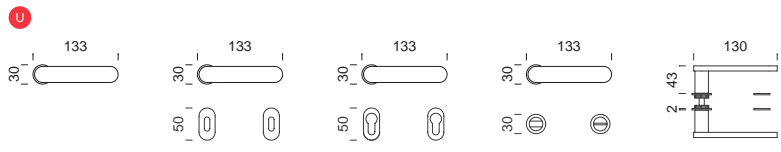

SH80 SH80P SH80Y SH80T

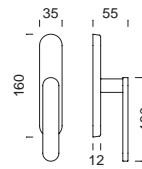

SH20C
SH21M

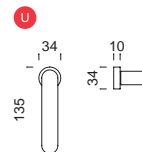

SH22U

sike

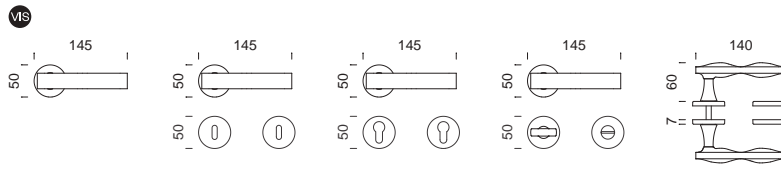

SK12 SK12P SK12Y SK12T

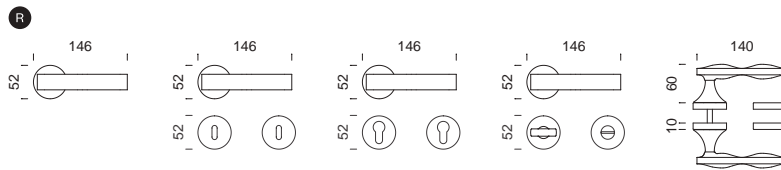

SK14 SK14P SK14Y SK14T

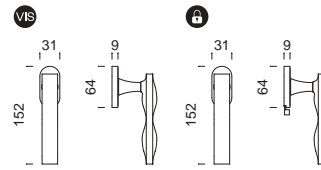

SK22V SK22TS

sike 02

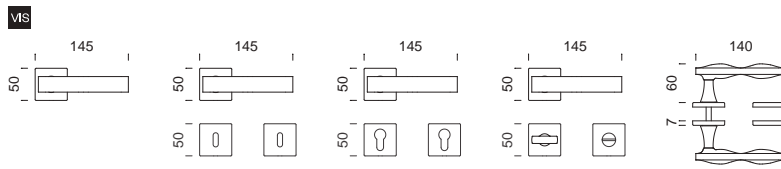

SK13 SK13P SK13Y SK13T

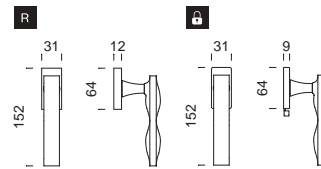

SK25 SK25TS

silvyana

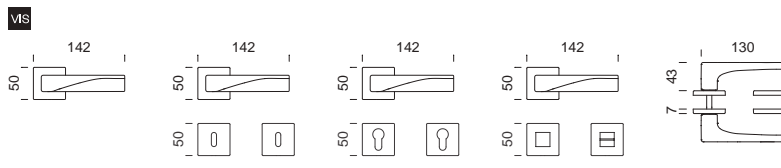

52/14 52/14P 52/14Y 52/14T

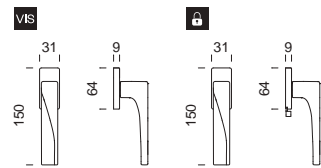

52QV 52QTS

silvyana

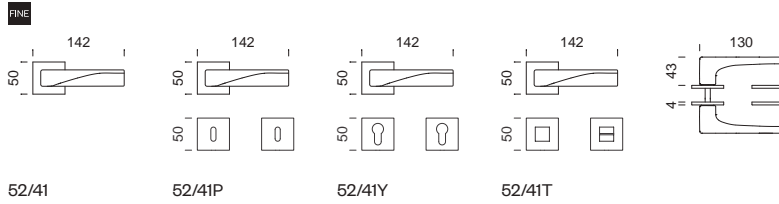

sochic

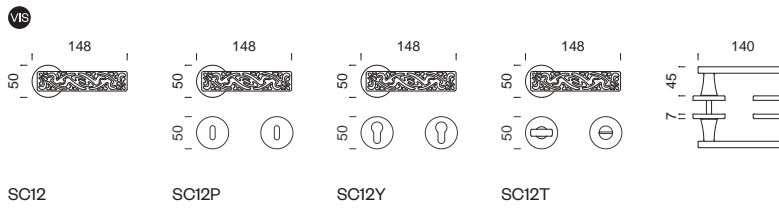

SC12

SC12P

SC12Y

SC12T

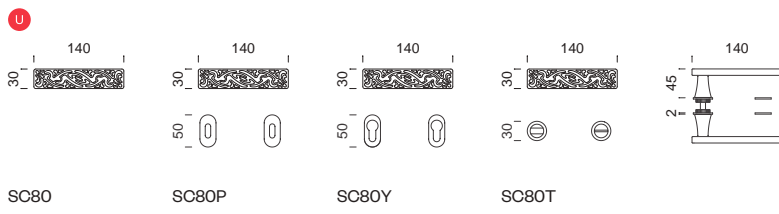

SC80

SC80P

SC80Y

SC80T

sochic O2

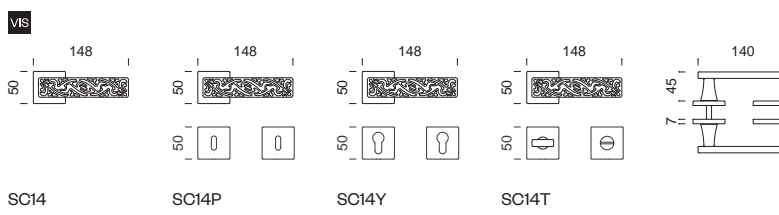

SC14

SC14P

SC14Y

SC14T

sochic L

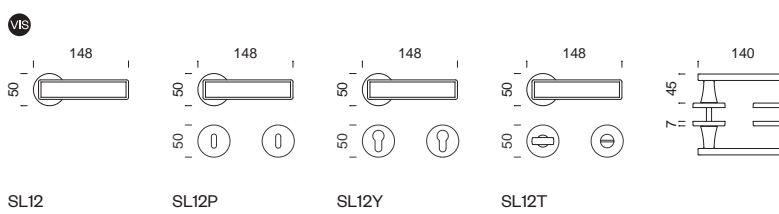

SL12

SL12P

SL12Y

SL12T

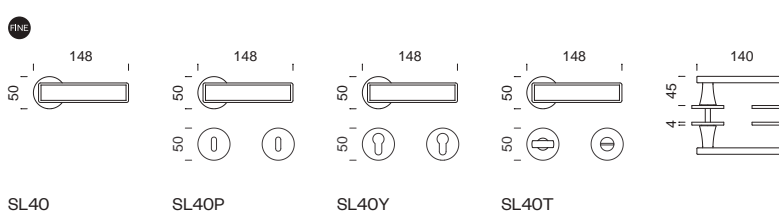

SL40

SL40P

SL40Y

SL40T

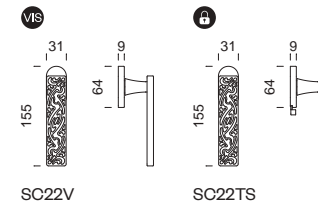

SC22V

SC22TS

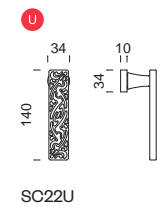

SC22U

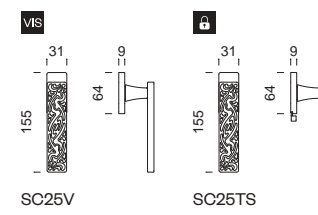

SC25V

SC25TS

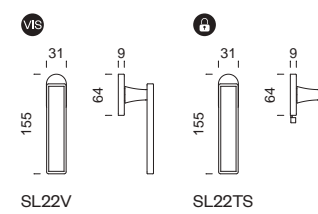

SL22V

SL22TS

sohic L 02

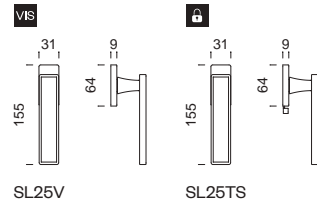
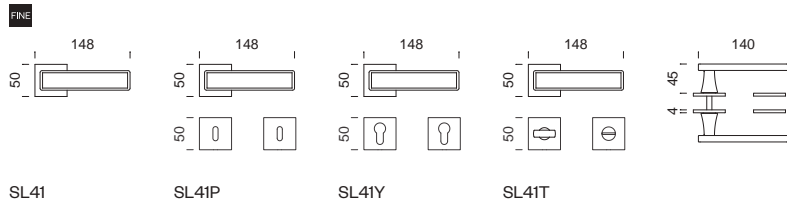
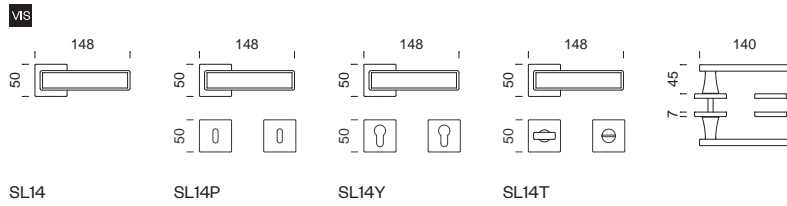

stick 02

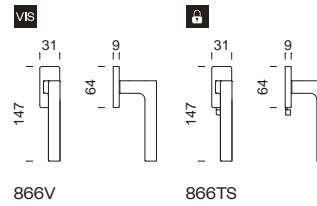
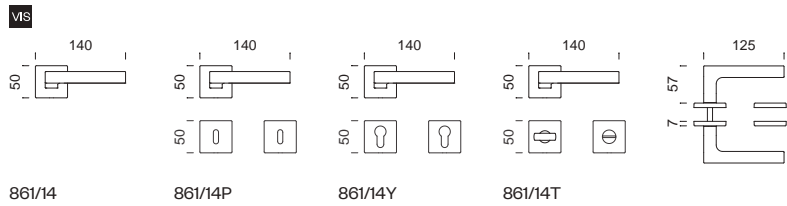

thelma

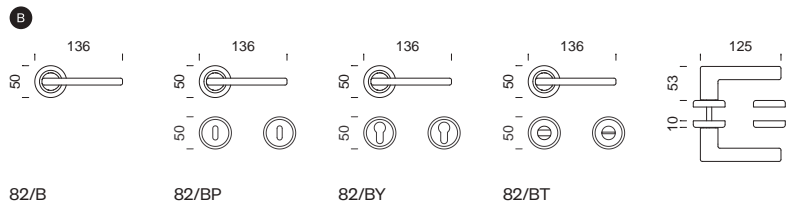
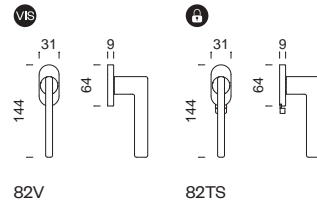
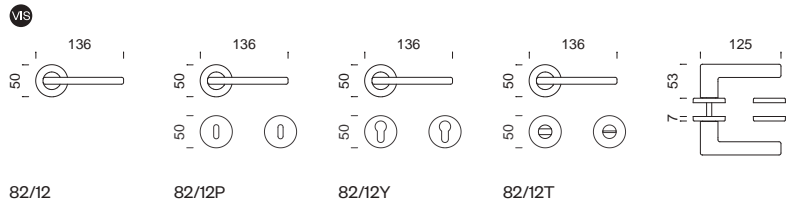

timeless

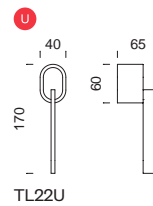
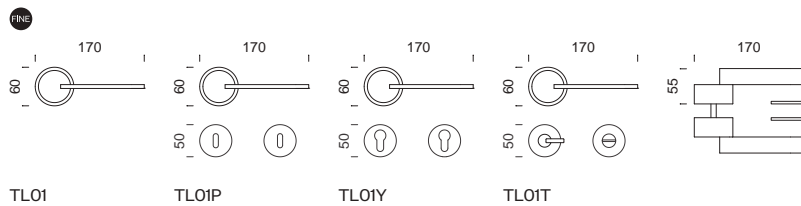

tipo-z

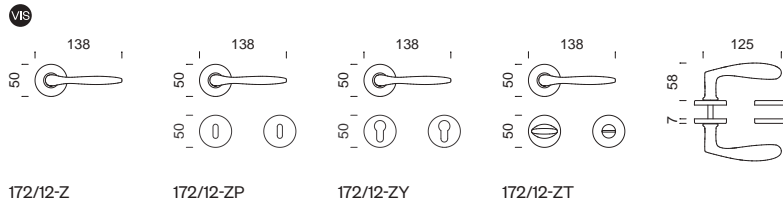

172/12-Z 172/12-ZP 172/12-ZY 172/12-ZT

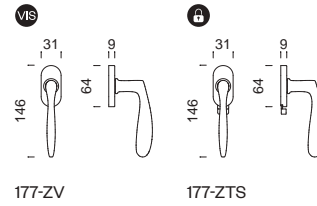

177-ZV 177-ZTS

twist

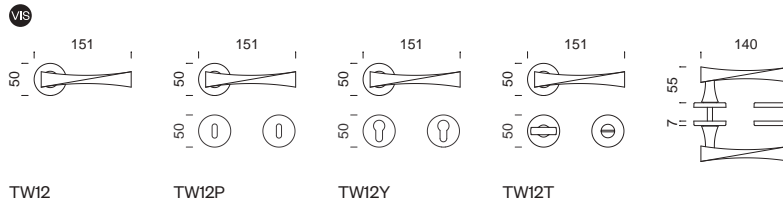

TW12 TW12P TW12Y TW12T

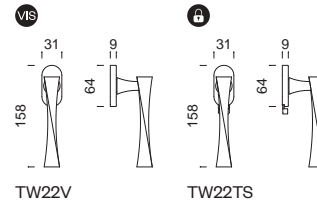

TW22V TW22TS

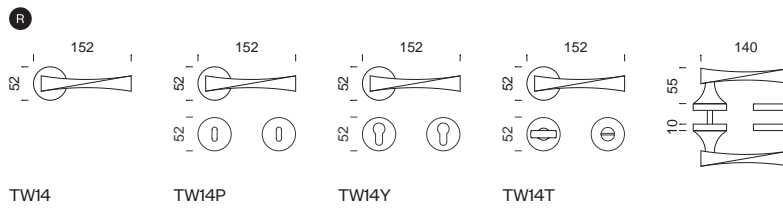

TW14 TW14P TW14Y TW14T



TW25 TW25TS

twist 02

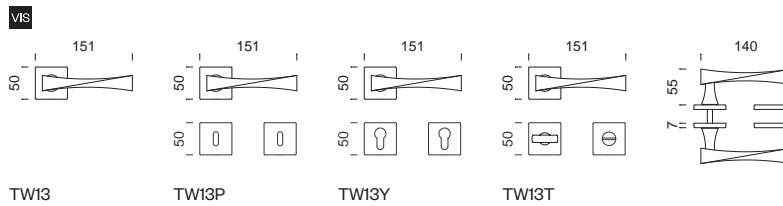

TW13 TW13P TW13Y TW13T

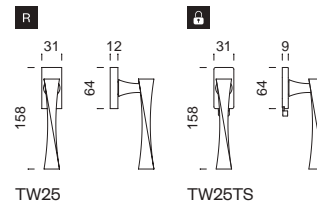

TW25 TW25TS

vita

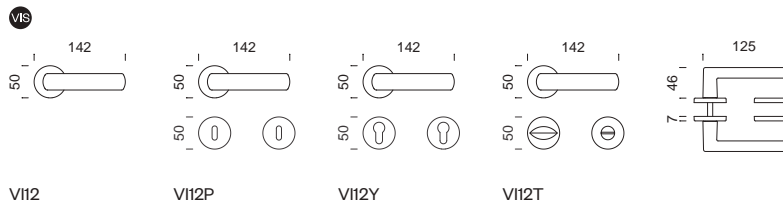

VI12 VI12P VI12Y VI12T

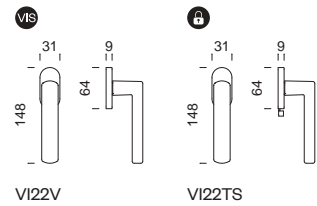

VI22V VI22TS

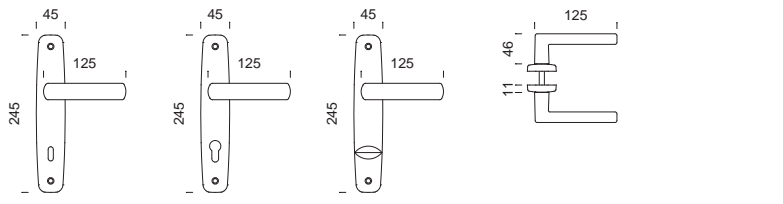

VI10P VI10Y VI10T

viva!

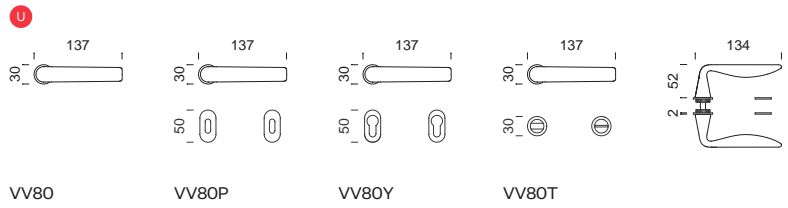
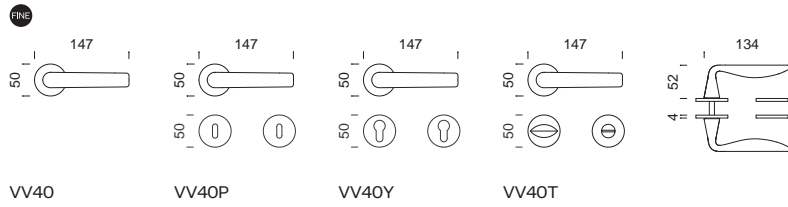
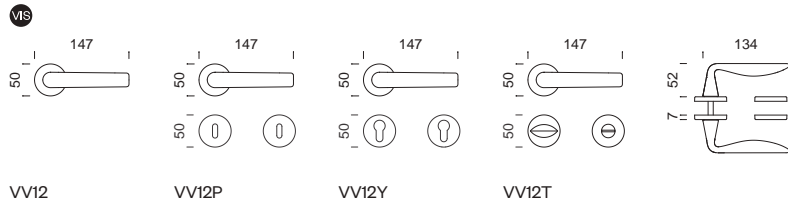

disegni tecnici technical drawings

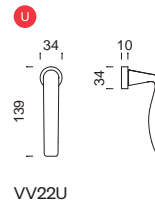
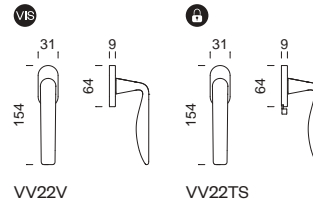

zeppelin

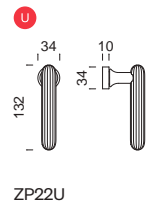
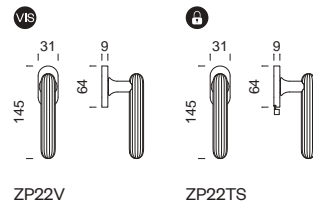
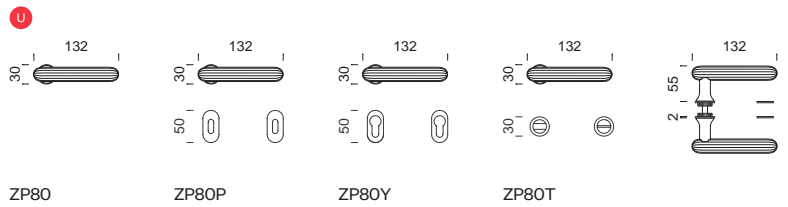
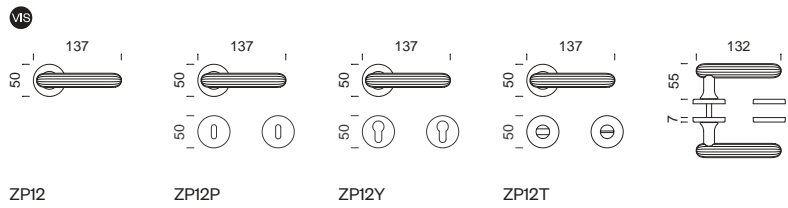

Tutte le quote riportate nel catalogo sono espresse in millimetri
All dimensions in the catalogue are in millimetres

note / notes

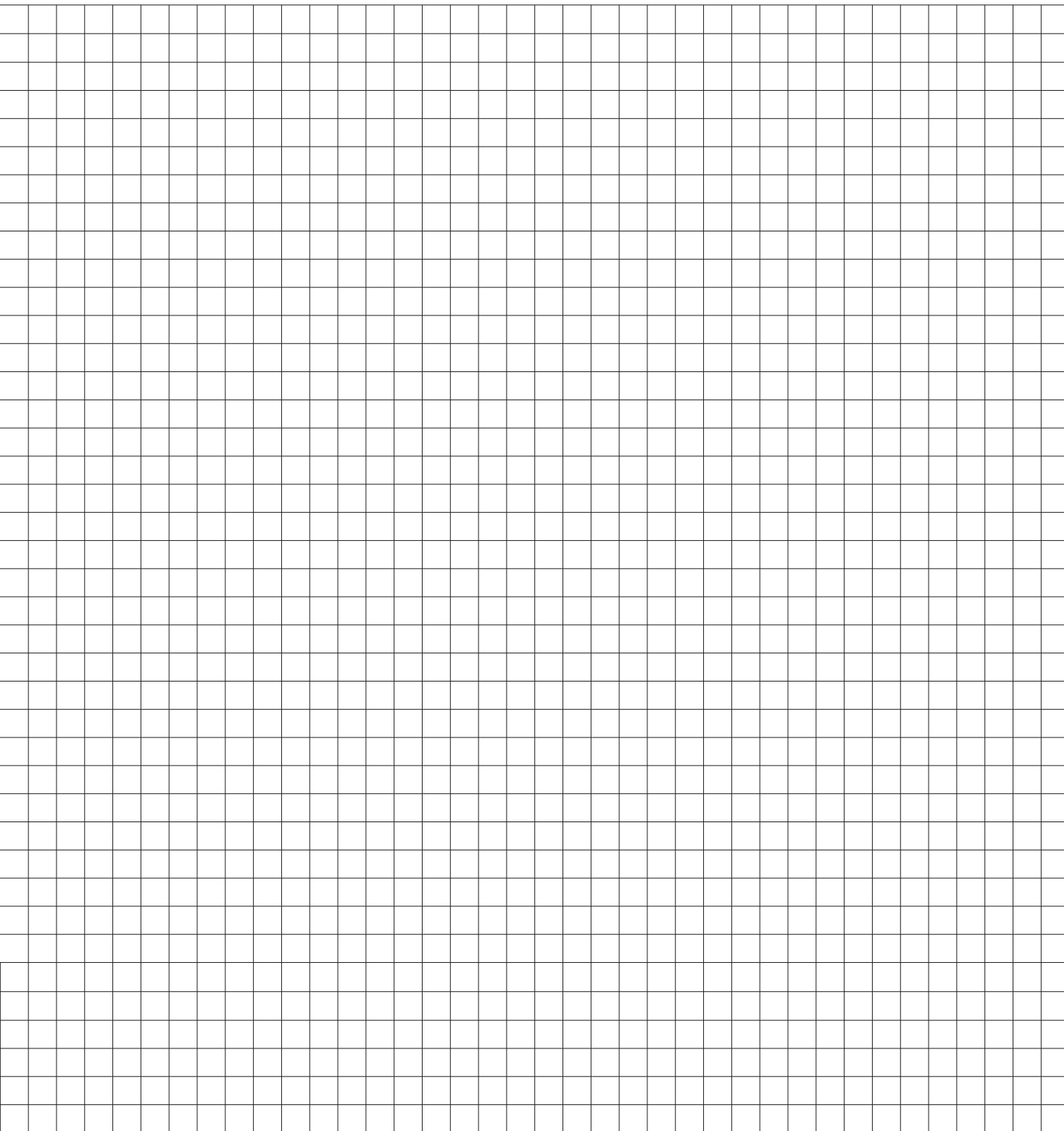

Copertina /

Cover

Leonardo Sonnoli

Irene Bacchi

- Studio Sonnoli -

Progetto grafico /

Graphic design

Dnd Marketing Dept.

Lorenzo De Bon

Marco Tonet

- Webkolm -

Fotografie /

Photographs

Tiziano Reguzzi

Stampa /

Printing

Tipolitografia Pagani



dnd

Dnd Martinelli S.r.l.

Via Piani di Mura, 2
25070 Casto (BS) - Italia

T +39 0365 899113

info@dndhandles.it

www.dndhandles.it



© 2024 Dnd Martinelli S.r.l.

Tutti i diritti riservati
All rights reserved

dnd

handles
with care

dndhandles.it
made in italy



Versione digitale
del catalogo

*Digital version
of the catalogue*